

# Sources, Fate, Transport, and Effects (SFTE) of Nutrients as a Basis for Protective Criteria in Estuarine and Near-Coastal Waters

## Weeks Bay, Alabama Pilot Study



Prepared for:



The Gulf of Mexico Alliance  
1141 Bayview Avenue  
Biloxi, MS 39530

Under the direction of:



1400 Coliseum Boulevard  
Montgomery, AL 36110



515 Amite Street  
Jackson, MS 39201

March 29, 2013



# Sources, Fate, Transport, and Effects (SFTE) of Nutrients as a Basis for Protective Criteria in Estuarine and Near-Coastal Waters

## *Weeks Bay, Alabama Pilot Study*

*Prepared for*

Gulf of Mexico Alliance  
Nutrient Priorities Issues Team

*Under the direction of*

Alabama Department of Environmental Management  
Water Quality Branch  
1400 Coliseum Boulevard  
Montgomery, AL 36110

*and*

Mississippi Department of Environmental Quality  
Office of Pollution Control  
515 Amite Street  
Jackson, MS 39201

*Prepared by*

Tetra Tech, Inc.  
400 Red Brook Boulevard, Suite 200  
Owings Mills, MD 21117-5172

March 29, 2013

## **Abstract**

This report summarizes a sources, fate, transport and effects (SFTE) study, the results of which are intended to provide the technical foundation for pilot nutrient criteria for Weeks Bay, Alabama. Linked watershed loading, hydrodynamic, and water quality models were constructed for the Weeks Bay and its contributing watershed and calibrated with detailed and comprehensive water quality monitoring data collected in 2011. Two reports were developed: the first report describes primary monitoring results and incorporates them into an existing, longer term data set. This expanded data set was used to conduct empirical statistical modeling of nutrient and response data to inform nutrient threshold development. The second report consists of the mechanistic modeling development, calibration, validation, and results. The preliminary conclusions of these models provide complementary evidence of nutrient enrichment-related responses in the estuary but also support a general conclusion that existing conditions could protect aquatic life uses into the future. Preliminary annual geometric mean threshold recommendations fell in the range of 0.08–0.10 milligram per liter (mg/L) for total phosphorus, 1.5–1.7 mg/L for total nitrogen, and 9 micrograms per liter ( $\mu\text{g/L}$ ) chlorophyll *a* (spectrophotometric) or 20–30  $\mu\text{g/L}$  (fluorometric). Recommendations for future monitoring and modeling efforts are also provided.

## Acknowledgment

This project was funded by the National Oceanic and Atmospheric Administration through a grant to the Mississippi Department of Environmental Quality (MDEQ) (no. NA08NOS4730395). As the lead member agency for the Nutrients Priority Issues Team (PIT) in the Gulf of Mexico Alliance (GOMA), the MDEQ administered the project as work order 11-00107TT-01 to Tetra Tech, Inc. (as part of contractual agreement no. 11-00107) The Alabama Department of Environmental Quality (ADEM) was the client lead for all technical and procedural issues.

The primary authors are James Stribling and Michael Paul (Tetra Tech, Inc., Owings Mills, MD). They were assisted through discussion, document reviews by Lei Zheng and Jeroen Gerritsen (Tetra Tech-Owings Mills, MD). Technical overview, document reviews were provided by Mr. Lynn Sisk and Mr. Chris Johnson (ADEM-Water Division-Water Quality Branch), Mr. Fred Leslie (ADEM-Field Operations Division), Ms. Kim Caviness (MDEQ-Water Quality Standards and Special Projects Branch), Ms. Kay Whittington (MDEQ-Watershed Management Branch). Kay Whittington was the MDEQ project manager, Ann Porter is the coordinator of the GOMA Nutrients PIT, and Mr. Ray Montgomery was overall contracts manager.

Photo images on the report cover were provided by Mr. Lynn Sisk (ADEM); the aerial image of Weeks Bay was taken via Google Earth™.

Proper citation of this report:

GOMA (Gulf of Mexico Alliance). 2013. *Sources, Fate, Transport, and Effects (SFTE) of Nutrients as a Basis for Protective Criteria in Estuarine and Near-Coastal Waters: Weeks Bay, Alabama Pilot Study*. Prepared for the Gulf of Mexico Alliance, Nutrients Priority Issues Team (Alabama Department of Environmental Management, and the Mississippi Department of Environmental Quality) by Tetra Tech, Inc., Owings Mills, MD.

For further information, contact Mr. Lynn Sisk (334-271-7826, LS@adem.state.al.us), Ms. Kim Caviness (601-961-5390, kim\_caviness@deq.state.ms.us), or Ms. Kay Whittington (601-961-5729, kay\_whittington@deq.state.ms.us).

## Contents

1	Introduction .....	1
2	Background .....	1
3	Water Body Overview .....	3
3.1	Landscape Setting .....	4
3.2	Hydrologic Setting .....	5
3.3	Ecological Setting .....	5
3.4	Nutrient Dynamics .....	6
4	Study Approach .....	6
4.1	Study Intent and Design .....	6
4.2	Analytical Monitoring Approach .....	7
4.3	Mechanistic Modeling Approach .....	9
5	Monitoring and Empirical Modeling Report Summary .....	10
5.1	Overview .....	10
5.2	Results Summary .....	13
6	Mechanistic Modeling Report Summary .....	20
6.1	Overview .....	20
6.2	Results Summary .....	20
7	Summary and Recommendations .....	21
7.1	Protective Thresholds .....	21
7.2	Monitoring Design .....	22
7.3	Modeling .....	23
8	References .....	25
	Appendix A: Empirical Analysis of Monitoring Results for Weeks Bay, Alabama	
	Appendix B: Hydrodynamics and Water Quality Modeling for Weeks Bay, Alabama	

## Tables

Table 1. General calibration/validation targets for EFDC/WASP7 applications.....	20
Table 2. Surface phytoplankton biomass (90th percentile) in Weeks Bay .....	20
Table 3. 90 <sup>th</sup> percentile long-term geometric mean TN, TP, and chl <i>a</i> concentrations in Weeks Bay.....	21
Table 4. Suggested nutrient and chlorophyll water quality thresholds for Weeks Bay, Alabama, resulting from the weight-of-evidence approach based on empirical and mechanistic modeling results.....	22

## Figures

Figure 1. Location of Weeks Bay relative to the overall Mobile Bay estuary system.....	3
Figure 2. The Fish and Magnolia Rivers are the two principal surface sources of freshwater inflow to Weeks Bay. ....	4
Figure 3. Improved understanding of nutrient concentrations and loadings will help develop their relationship to (A) dissolved oxygen and chlorophyll and (B) response of benthos or other aquatic organisms to stressors produced by those processes.....	7
Figure 4. Sampling sites used for the Weeks Bay SFTE nutrient criteria pilot study.....	8
Figure 5. Linkages among LSPC, EFDC, and WASP models used for helping describe hydrodynamic and water quality linkages of the Weeks Bay system.....	10
Figure 6. Continuous monitoring data showing DO fluctuation during four sampling events on April 17–20, June 13–17, July 5–8, and September 19–23.....	11
Figure 7. Nutrient fluctuation during the four episodic nutrient survey periods in five mid-bay stations and one Mobile Bay station.....	12
Figure 8. TN concentrations for 13 stations over the Weeks Bay system. ....	13
Figure 9. TP concentrations for 13 stations over the entire Weeks Bay system. ....	14
Figure 10. Chl <i>a</i> concentrations for 13 stations over the entire Weeks Bay system.....	15
Figure 11. DO trends at different depths by sampling locations.....	16
Figure 12. Relationships between chl <i>a</i> and TN and TP concentrations in Weeks Bay. ....	17
Figure 13. The relationship between DO daily fluctuation and chl <i>a</i> concentration in the water column.....	18
Figure 14. The relative risk of daily minimum DO less than 5 mg/L with increasing chl <i>a</i> concentrations.....	19





## 1 Introduction

Environmental stresses on global coastal ecosystems are widely recognized, along with familiar aspects of degradation, including broad changes in biological condition, species distributions, status of wetlands, and water quality (Halpern et al. 2008; Lotze et al. 2008). Sources of stressors that effect degradation of coastal ecosystems are diverse, and efforts to eliminate, reduce, or otherwise manage them are necessary for effective management and restoration. One of the major causes of degradation in coastal waters is nutrient enrichment, the recognition of which has been accompanied by substantial scientific research and regulatory initiatives to define processes, status, and effective limits on nutrient pollution (Mitsch et al. 2001; Rabalais 2002; Bricker et al. 2003; Diaz and Rosenberg 2008; Howarth 2008; Li et al. 2008; Conley et al. 2009; Duarte 2009). This research has been accompanied by policy and regulatory initiatives at the federal level—such as the 1998 Clean Water Action Plan and National Strategy for the Development of Regional Nutrient Criteria—and regional level—such as the Gulf of Mexico Alliance Nutrients and Nutrient Impacts Priority Area.

In this document, we present a synthesis of results from a study implemented to evaluate the sources, fate, transport, and effects (SFTE) of nutrients in a specific inland estuary of the northern Gulf of Mexico—Weeks Bay, Alabama. The objective of the study, and thus, this synthesis, is to recommend pilot nutrient criteria for protection of this estuarine system and, in so doing, to develop and model a process for combining technical understanding of nutrient characteristics and effects derived from monitoring observations with empirical analysis and water quality mechanistic modeling that can be used Gulf-wide to derive nutrient criteria to help protect Gulf of Mexico ecosystems from nutrient enrichment.

## 2 Background

Water quality standards are the cornerstone of water quality protection in the United States under the Clean Water Act of 1972 (CWA)<sup>1</sup> and title 40 of the *Code of Federal Regulations* [CFR] part 131. They establish the water quality goals for every water body, meeting, at a minimum, the fishable/swimmable standard. Water quality standards are composed of designated uses, criteria to protect those uses, and strategies to prevent the degradation of existing water quality. Authority for setting water quality standards is a state responsibility, and all five Gulf States have developed water quality standards for their coastal waters.

Water quality criteria serve several purposes. States use water quality criteria for impairment/nonimpairment assessment purposes in delivering biennial water quality reports (CWA section 305[b]) to the U.S. Environmental Protection Agency (EPA), required under the CWA. Waters meeting their criteria are attaining their uses, whereas those exceeding their criteria are considered impaired for their uses. The second use of criteria is in setting water quality targets for impaired waters. For those waters that are assessed as impaired for their uses on the basis of data of known quality, water managers must set an allowable load of pollutant(s) necessary to meet those uses, known as total maximum daily loads (TMDLs). These TMDLs are derived from water quality criteria, where criteria exist.

---

<sup>1</sup> FWPCA. 2008. Federal Water Pollution Control Act (33 U.S.C. 1251 et seq.) As amended through P.L. 110-288, July 29, 2008. As in effect January 4, 2011.  
[http://www.waterboards.ca.gov/laws\\_regulations/docs/fedwaterpollutioncontrolact.pdf](http://www.waterboards.ca.gov/laws_regulations/docs/fedwaterpollutioncontrolact.pdf).

The third application of water quality criteria is for controlling and managing point source discharges of pollutants. Facilities or other entities responsible for point source discharges receive permits to discharge pollutants, the limits for which are established, in part, by water quality criteria. If it is determined that a discharger has a reasonable potential to violate a water quality criterion, limits on that pollutant are required in addition to those from technology-based treatment standards. This is especially applicable for nutrients, because EPA has not published such treatment standards for nutrients. In addition to these three main applications (assessment, TMDLs, and permitting), water quality criteria are frequently referenced in other programs such as, e.g., nonpoint source management, restoration, watershed planning, and evaluation of various pollutant control activities, such as best management practices.

To protect their uses, states are required to develop a sufficient variety of criteria, on the basis of sound science, and including the sufficient variety of parameters and constituents needed. If a water body has multiple uses, criteria are applied for protection of the most sensitive use [40 CFR 131.11(a)(1)]. In establishing criteria, states should establish numeric criteria on the basis of federal guidance or other scientifically defensible methods or they may establish narrative criteria or criteria based on biological monitoring where numeric criteria cannot be established or to supplement numeric criteria [40 CFR 131.11(b)]. EPA has developed guidance to inform the selection of criteria and to apply sound science where numeric criteria need to be developed or updated (e.g., USEPA 2001). Most states, historically, protected uses from nutrient enrichment through narrative *free-from* criteria (e.g., “waters shall be free from materials attributable to municipal, industrial, agricultural, or other discharges producing . . . conditions in such degree as to create a nuisance, render the waters injurious to public health, recreation, or to aquatic life and wildlife, or adversely affect the palatability of fish, aesthetic quality, or impair the waters for any designated use.” Mississippi Department of Environmental Quality Water Quality Standards). By the 1990s, the frequency of nutrient problems and nutrient-related impairments had increased to a level that the federal government felt the time for more stringent numeric criteria had arrived. The Clean Water Action Plan of 1998 highlights this problem and establishes a need for stronger approaches to curb nutrient pollution.

EPA, in response to increasing recognition of nutrient enrichment as a problem, launched the *National Strategy for the Development of Regional Nutrient Criteria* (USEPA 1998). Guidance documents providing sound scientific methods for establishing numeric nutrient criteria for each waterbody type, including for estuaries, soon followed (USEPA 2001) along with recommended regional numeric nutrient criteria for inland waters as required under CWA section 304(a) (e.g., USEPA 2000). EPA has continued to provide support to states for completing numeric nutrient criteria, to build capacity for states deriving protective numeric nutrient criteria, to improve the science for updating and refining CWA section 304(a) criteria, and for communicating the risks of nutrient pollution and merits of numeric nutrient criteria. Such dangers pose a real threat to the ecosystem goods and services (e.g., fisheries, clean water, recreation) on which the Gulf region depends.

One of the principal areas of concern for the long term health of the Gulf of Mexico is the quantity of nutrients being put into estuarine and near-coastal waters from continental, land-based origins. Nutrients enter these systems by several different pathways, including riverine inflows, atmospheric deposition, and coastal point source discharges (Boesch 2002; Rabalais 2002; Diaz and Rosenberg 2008; Howarth 2008). Management of water resource quality relative to nutrients requires an understanding of their dynamics once in the water body, and some benchmark against which to compare observed conditions. Lack of measureable and objective benchmarks compromises the objectivity of management decision-making, thus weakening protections of the resources (Hagy et al. 2008).

The Gulf of Mexico Alliance (GOMA), recognizing the threat posed by nutrient enrichment and the need to correct the void in measureable and objective benchmarks for nutrients, developed nutrients and

nutrient impacts as one of its six core priority areas under the *Governors' Action Plan II* (GOMA 2009a), with the Nutrients Priority Issues Team (PIT) tasked to lead this effort. The Nutrients PIT's four focus areas are nutrient characterization, nutrient criteria development, hypoxia, and nutrient reduction strategies. One step in the Nutrient Characterization Focus Area, specifically, is conducting nutrient SFTE studies in Gulf ecosystems to better understand nutrient loading and its effects. These are being accomplished by developing specific, detailed, mechanistic water quality models of a series of estuaries, including Weeks Bay, Alabama, accompanied by detailed, focused monitoring efforts to calibrate and validate these models. These SFTE projects integrate with a principal action step of the Nutrient Criteria Development Focus Area: piloting the process for developing and evaluating nutrient criteria in Gulf coastal estuaries. The SFTE projects provide the necessary data and combination of analyses required to support development of scientifically sound numeric nutrient criteria. The study on which this report is based was designed with the intent of providing technical information and other output relevant to characterizing nutrients and nutrient loadings in inland estuaries and to pilot an approach for developing and evaluating nutrient criteria. It is one of four focused on SFTE of nutrients in estuarine waters of the Gulf of Mexico that are sponsored by the Nutrients PIT; in addition to Weeks Bay (Alabama), they are St. Louis Bay, Mississippi, and Mission Aransas and Galveston Bay, Texas.

### 3 Water Body Overview

Weeks Bay, Alabama, is a sub-estuary (or tributary estuary) to the southeastern portion of the Mobile Bay Estuary system, and is near the northern extent of Bon Secour Bay (Figure 1); the entire Mobile Bay system is bounded in the north by Mobile River delta and in the south by waters of the northern Gulf of Mexico. It has been part of the National Oceanographic and Atmospheric Administration (NOAA) National Estuarine Research Reserve System (NERRS) since 1986 (Miller-Way et al. 1996; NOAA 2013a).

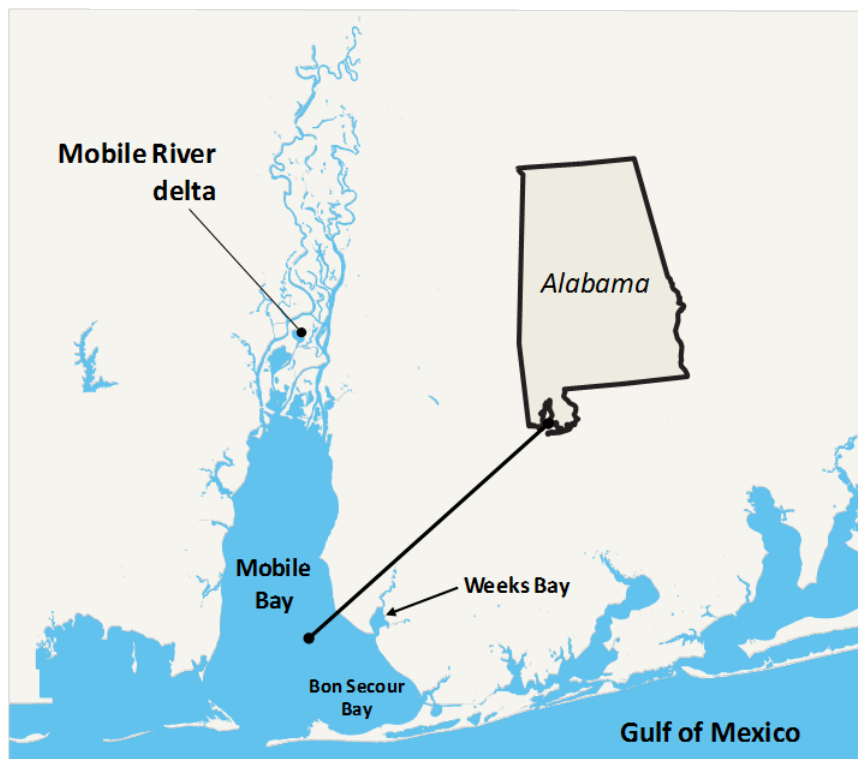
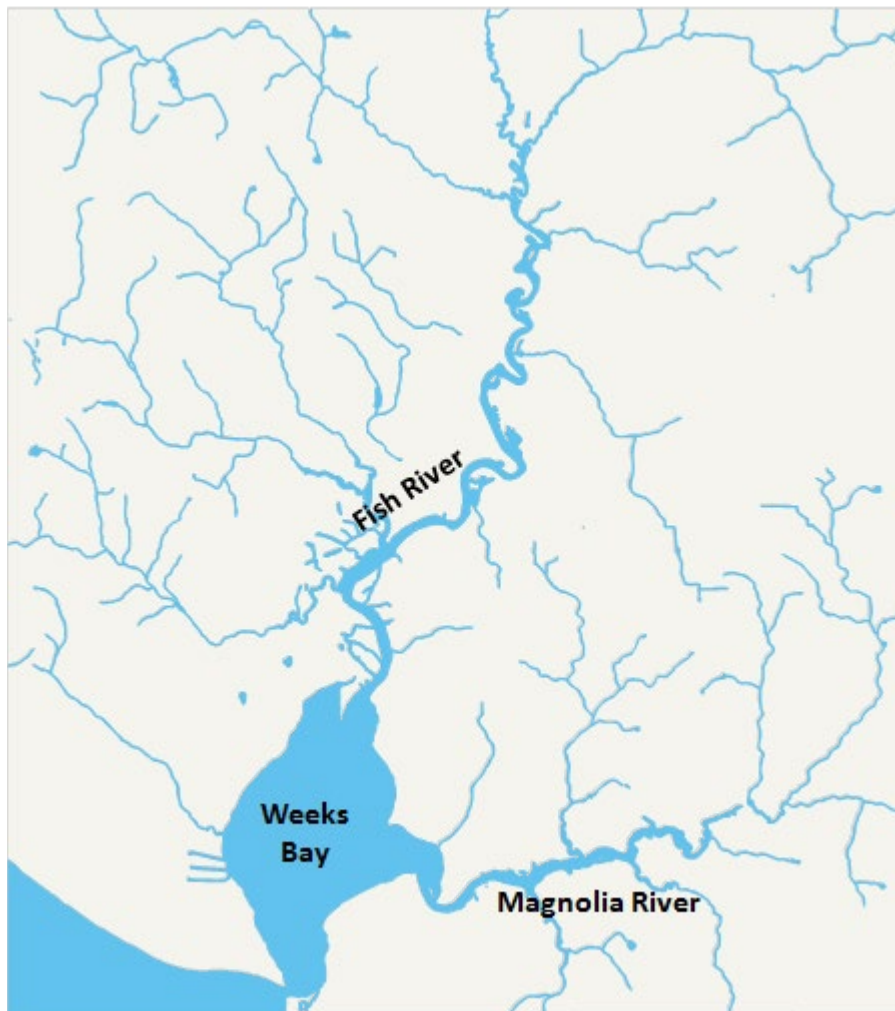

Figure 1. Location of Weeks Bay relative to the overall Mobile Bay estuary system.

### 3.1 Landscape Setting

The watershed providing freshwater inflows to Weeks Bay drains an area of about 510–521 square kilometers (km<sup>2</sup>) (O’Neil and Chandler 2003; Lehrter 2008), which is composed of two river subbasins, the Fish River and the Magnolia River. The bay is roughly diamond shaped (Miller-Way et al. 1996), with the Fish River flowing north to south and the Magnolia River flowing east to west (Figure 2). Using data from the mid-1990s, Lehrter (2008) estimated that approximately 59 percent of the land use/land cover was in agricultural production as row-crop and pastureland. Other authors have estimated percentages of around 49, 34, and 7 for forest, cropland, and pasture/hay cover, respectively, along with ongoing and rapid increases in residential land uses associated with a number of smaller towns and communities (Daphne, Fairhope, Foley, Loxley, Robertsedale, Silverhill, and Summerdale) (O’Neil and Chandler 2003; Weeks Bay NERRS 2007; Morrison 2011). Our analysis (Appendix B) using the National Land Cover Data (2006) shows the drainage area to be approximately 545 km<sup>2</sup>, comprising 50 percent agriculture (row crops, pasture/hay), 22 percent forest and shrubland, and about 15 percent wetlands (forested and emergent herbaceous), suggesting potentially a substantial shift in dominance over about a 10-year period from forest cover to agriculture use.



**Figure 2. The Fish and Magnolia Rivers are the two principal surface sources of freshwater inflow to Weeks Bay.**

In the Weeks Bay watershed are approximately 30 facilities with individual National Pollutant Discharge Elimination System (NPDES) permits and a much larger number of facilities with general NPDES permits for storm water discharges. Of the 30 NPDES permits, only 2 are for wastewater treatment facilities. The Loxley wastewater treatment plant (NPDES AL0060283), with a design flow of 0.75 million gallons per day, is in the town of Loxley and discharges to the Fish River at Baldwin County Road 64 (Lat. 30.604, Long. -87.8176) approximately 13 miles (21 km) north of Weeks Bay. The Spanish Fort wastewater treatment plant, also known as Plantation Hills (NPDES AL0042234), has a design flow of 1.25 million gallons per day and discharges to Bay Branch approximately 0.3 mile (0.5 km) upstream of the Fish River and 0.8 miles (1.3 km) south of US Highway 90 (Lat. 30.633673, Long. - 87.818922) near the northern boundary of the Weeks Bay watershed. The remaining facilities with individual NPDES permits are primarily sand and gravel mining operations.

### 3.2 Hydrologic Setting

The two principal inflows to the bay provide a combined discharge of around 9 cubic meters per second (Miller-Way et al. 1996), with the Fish River contributing more than 70 percent of the total. The bay itself has a surface area of approximately 6.9 km<sup>2</sup>, and water depth generally varying from slightly less than 1 meter to around 2–3 meters from the upper to lower bay.

The daily high and low tides have a mean range of approximately 0.4 meter, and maximum current velocity measured just inside the mouth of Weeks Bay range from 40–65 centimeter per second (Miller-Way et al. 1996). The mouth of the bay opening into Bon Secour and Mobile Bays is narrow, approximately 0.14 km (as measured in GoogleEarth™); maximum current velocity at the mouth has been estimated at 103 cubic meters per second.

### 3.3 Ecological Setting

The Weeks Bay watershed is in two ecoregions, the Southern Pine Plains and Hills (ecoregion 65f), and the Gulf Coast Flatwoods (ecoregion 75a), which are described as follows (Griffith et al. 2001; O’Neil and Chandler 2003):

65f. The Southern Pine Plains and Hills have a different mix of vegetation and land use compared to 65d, and streams tend to be darker tea-colored and more acidic as one moves south. The oak-hickory-pine forest of the north in 65d grades into Southern mixed forest and longleaf pine forest in this region. The longleaf pine forest provided habitat for now rare or endangered species such as the red-cockaded woodpecker, gopher tortoise, eastern indigo snake, and Florida pine snake. Loblolly and slash pine plantations now cover wide areas. The hill summits and higher elevations are composed of the Citronelle formation, generally sandy, gravelly, and porous, and more resistant (sic) to erosion than the older underlying Miocene sandstones.

75a. The Gulf Coast Flatwoods ecoregion stretches from eastern Louisiana, across southern Mississippi and Alabama, and into west central Florida. In Alabama, it is a narrow region of nearly level terraces and delta deposits composed of Quaternary sands and clays. Wet, sandy flats and broad depressions that are locally swampy are usually forested, while some of the better-drained land has been cleared for pasture or crops. Most of the Mobile urban area is also contained in this region.

Common habitats in the bay are varied, exhibiting structure that is considered subaerial, intertidal, nontidal emergent wetlands, and disturbed (Miller-Way et al. 1996). It includes tupelo/cypress swamps along tidal streams, shoreline herb/grass/rush assemblages, abundant cordgrass marsh areas, and a few grassbeds. The Weeks Bay research reserve website provides a detailed description of the different habitats in the bay and adjacent watershed (NOAA 2013b).

### 3.4 Nutrient Dynamics

The dynamics of nutrients in the Weeks Bay Estuary are detailed in the modeling report (Appendix B), and in broad terms, are similar to those in many estuaries. Both point sources from both municipal and industrial facilities and nonpoint sources from residential/commercial and agricultural land uses exist and contribute to nutrient loads. These are transported by the riverine systems, with predominant transport from the Fish and Magnolia Rivers, and contributions from the Mobile Bay. In the estuary, nutrients are transported into and across the estuary, and exchange occurs between surface and subsurface layers as freshwaters mix with more saline Mobile Bay waters.

Nutrient species include both dissolved and particulate organic and inorganic forms. From the monitoring report (Appendix A), it appears that particulate fractions dominate the phosphorus pool, with soluble reactive phosphorus representing a small fraction of the total load. For nitrogen, on average, nitrate/nitrite ( $\text{NO}_{2+3}$ ) is approximately one-third of the average study period total nitrogen (TN = total Kjeldahl nitrogen [TKN] + total nitrate/nitrite [ $\text{NO}_{2+3}$ ]), with the other two-thirds organic nitrogen (TKN). Organic nitrogen usually represents the largest fraction in natural estuaries and an average nitrate/nitrite of 0.55 mg/L and total nitrogen (TN) greater than 1 mg/L, represents concentrations typically associated with more productive or eutrophic conditions (Bricker et al. 2003).

The typical fate of phosphorus in estuaries is uptake and assimilation into biomass with subsequent export into sediments or adjacent systems and, ultimately storage/burial (Schlesinger 1997). The fate of nitrogen is more varied given its complex biogeochemical cycle. For example, it includes the same fates as phosphorus and reduction of oxidized nitrate/nitrite into reduced gaseous nitrogen forms in anoxic areas where  $\text{NO}_{2+3}$  serves as electron acceptors for denitrifying heterotrophs and decomposition of organic nitrogen into ammonia ( $\text{NH}_4$ ), which can be taken up or oxidized. Phosphorus and nitrogen frequently limit biological productivity, and one fate of phosphorus and nitrogen is often stimulation of primary and secondary production, as exhibited by moderate average algal biomass (as measured by chlorophyll *a* [chl *a*]) of 6.7 parts per billion (ppb) and high maximum chl *a* concentrations of 107 ppb in Weeks Bay (Appendix A). The latter concentrations are associated with highly productive, even hyper-eutrophic systems, whereas the former are usually associated with more moderate conditions (Bricker et al. 2003). Nutrient enrichment leading to excess primary production can stimulate secondary production and heterotrophic respiration via decomposition (Barnes and Hughes 1988; USEPA 2001; Conley et al. 2009). The latter can lead to hypoxia and anoxia, which can be stressful for organisms, especially benthic organisms (USEPA 2001). Low, nearly anoxic, dissolved oxygen (DO) concentrations were observed during the monitoring study in parts of the estuary (Appendix A).

## 4 Study Approach

### 4.1 Study Intent and Design

This study's design was intended to accomplish several goals: (1) standardize a regional approach that could be used at locations around the Gulf of Mexico in a range of conditions and types of coastal waters, allowing customization and the ability to accommodate local conditions and focused program needs; (2) provide improved understanding and identify the core monitoring needed to characterize and understand nutrient sources, fate, transport, and effects; (3) provide sufficient understanding of the relationships among nutrients, water quality, physical processes, and biota to develop protective nutrient criteria for coastal ecosystems; and (4) optimize the study design to the minimum necessary to determine nutrient effects and guide establishing appropriate long-term monitoring sites, parameters, and methods.

For this study, we developed an integrated monitoring and modeling framework for the Weeks Bay System to contribute to developing pilot nutrient criteria, through a better understanding of the nutrient dynamics in the system and the potential effects on aquatic life. The *Nutrient Criteria Research Framework* (GOMA 2009b) of the Nutrients PIT addresses four major ecosystem compartments that form sources or sinks of the nutrients and the fluxes of nutrients among them. These compartments are atmosphere, biomass, water column, and sediment. In this project, nutrients are assessed through combined monitoring (data collection, analysis, and observation) and modeling techniques to assess nutrient inputs, loading, transport, fate, and biological responses (Figure 3). In addition, the framework incorporates monitoring data needed to setup, calibrate, and validate models to help quantify the relationships among nutrients, water quality, physical processes, and biological responses.

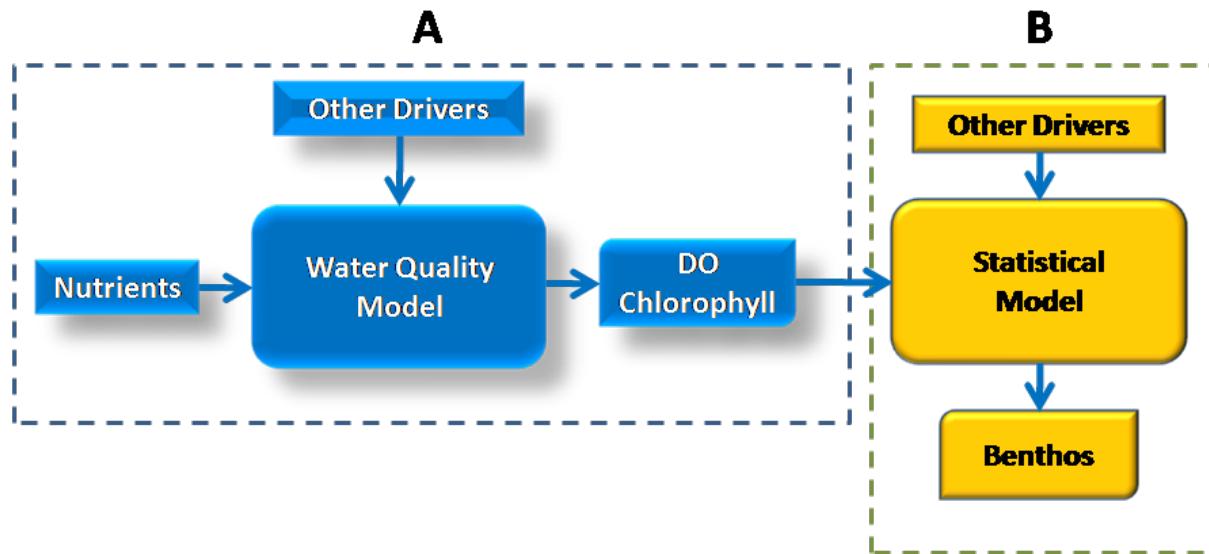

Note: Other drivers are environmental or climatic factors, or stressors, either measured or not, that can influence stressor loads and biological responses.

**Figure 3. Improved understanding of nutrient concentrations and loadings will help develop their relationship to (A) dissolved oxygen and chlorophyll and (B) response of benthos or other aquatic organisms to stressors produced by those processes.**

## 4.2 Analytical Monitoring Approach

Sampling and analysis for this project focused on 13 locations (Figure 4), 6 of which represent the upstream, freshwater inflows (4 and 2 on the Fish and Magnolia Rivers, respectively); 6 in the bay proper, including tidal locations at or near the river inflows; and 1 representing the Mobile Bay boundary condition. Sampling and other observations included physical, chemical, and biological characteristics (Appendix A), the suite and frequency of sampling and the analytes for each location differed depending on sample group and planned analyses. Descriptive statistics (mean, median, standard deviation, minimum, and maximum) were calculated and presented for each parameter, and examined for potential strata or site classes. Evaluation focused on total organic carbon (TOC), TN,  $\text{NO}_{2+3}\text{-N}$ , TP, chl *a*, turbidity, and total suspended solids (TSS) among potential site classes that could be defined, in part, by water temperature (temp), chlorine (Cl), DO, pH, specific conductance, or salinity. Other observations included 5-day carbonaceous biological oxygen demand (CBOD5), total dissolved solids (TDS), and dissolved reactive phosphorus (DRP). Samples of the benthic macroinvertebrate assemblage were taken at the six locations in the bay proper, with site-specific ratings allowing degraded/undegraded assessments for both individual sites, and the bay overall.

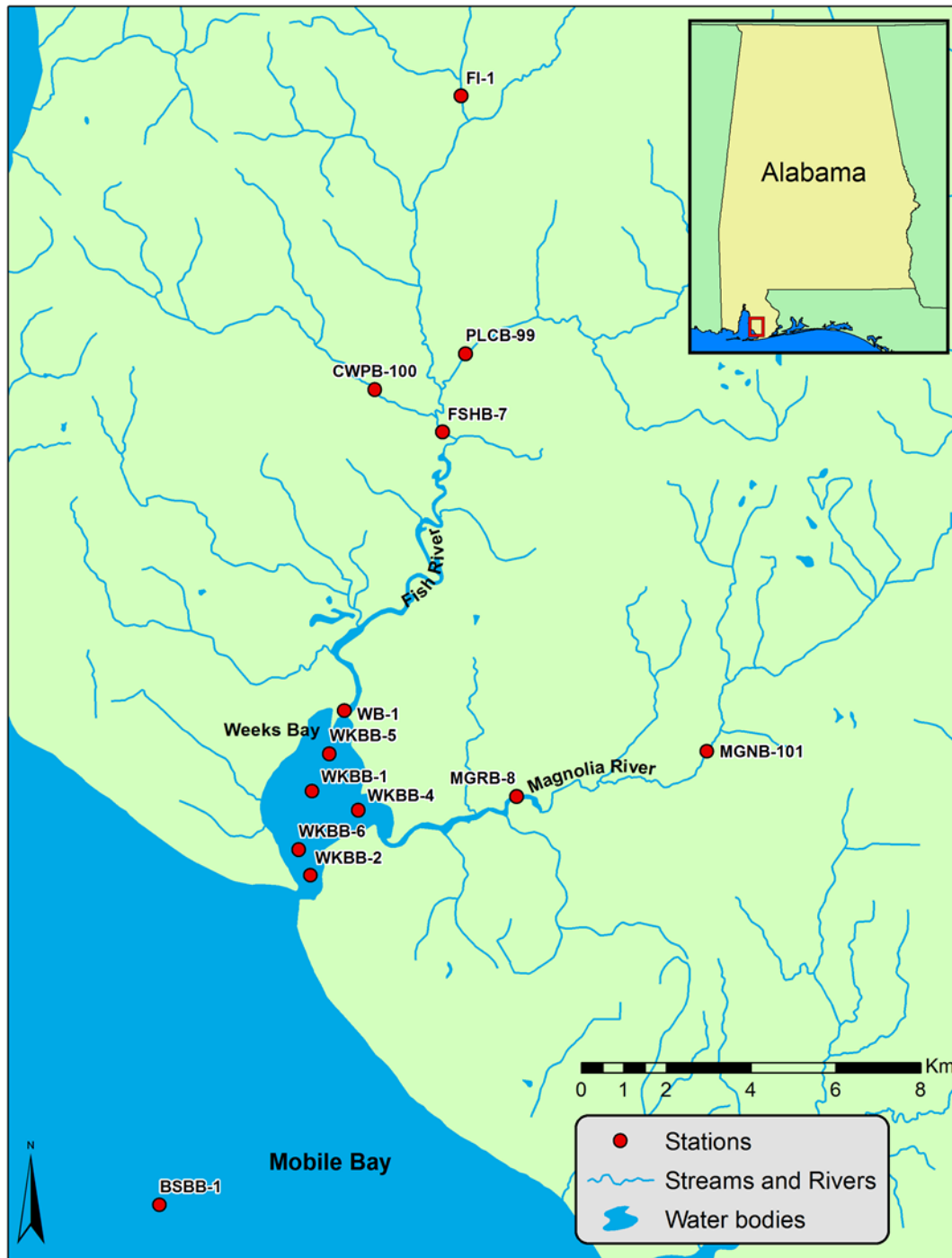

Figure 4. Sampling sites used for the Weeks Bay SFTE nutrient criteria pilot study.



The site classification process resulted in four strata: streams, tidal, mid-bay, and out-bay, which were used as the spatial framework for initial evaluation of nutrients in the Weeks Bay system. Some of the samples were collected monthly from February to November; others were associated with intensive monitoring intended to bracket neap and spring tides (one day each pre-, during, and post-). The neap/spring intensive surveys were intended to provide better understanding of short-term variation, whereas continuous sonde monitoring was for illustrating diel variation over a several-day period. For comparing within and among variables, and the spatial and temporal strata, we used combinations several different statistical visualization and characterization techniques, such as, cumulative daily curves, box-and-whisker plots, XY scatterplots, and time-series decomposition. Potential stressor-response associations were examined using Spearman correlation analysis, and regression analysis (linear and logistic), and selected modeling techniques (hierarchical and Bayesian).

### **4.3 Mechanistic Modeling Approach**

Mechanistic water quality modeling was performed to simulate the source, fate, transport, and effect of nutrients in the Weeks Bay system by modeling the processes driving hydrodynamic factors and water quality characteristics in the Weeks Bay system. These models were calibrated and validated with monitoring data and used to explore the effects of nutrient loading and modeled concentrations in support of pilot nutrient criteria development. A set of mathematical models of physical, chemical and biological processes was developed for bay and surrounding watersheds, using three computational codes (Appendix B). The Loading Simulation Program in C++ (LSPC) was used to represent hydrologic and water quality conditions in the watersheds and calculate nutrients loads to the bay. The Environmental Fluid Dynamics Code (EFDC) helped simulate hydrodynamics of Weeks Bay. Finally, the Water Quality Analysis Simulation Program (WASP [ver. 7.41]) was used for simulating spatio-temporal dynamics of nutrients, phytoplankton, DO, and other water quality constituents in the bay. Following calibration and validation of the models and their linkages (Figure 5), three scenarios were run to (1) correspond to existing nutrient loads, (2) represent natural conditions, i.e., without human-induced sources of nutrients, and (3) represent conditions following 50 percent load reductions. The purpose for evaluating three scenarios is to help understand potential sensitivity of the Weeks Bay system to nutrient load reductions and provide information helpful for evaluating potential numeric nutrient criteria.

Understanding of conditions in the bay is enhanced by better characterization of the contributing watershed area. The model for the watershed represents the variability of pollutant source contributions through dynamic representation of hydrology and land use practices and includes all point source contributions. Key components of the watershed modeling include watershed delineation, simulation period, soils, meteorological data, reach characteristics, land use representation, and known point source discharges.

The bay is segmented on an orthogonal, curvilinear grid system composed of more than 430 cells overlain on bathymetric data (NOAA 2012) to provide the framework for evaluating hydrodynamic characteristics and conditions. Data used for calibrating different aspects of the linked model system came from this monitoring study (Appendix A) and from the NERRS and Dauphin Island Sea Lab (NOAA 2013a, 2013c).

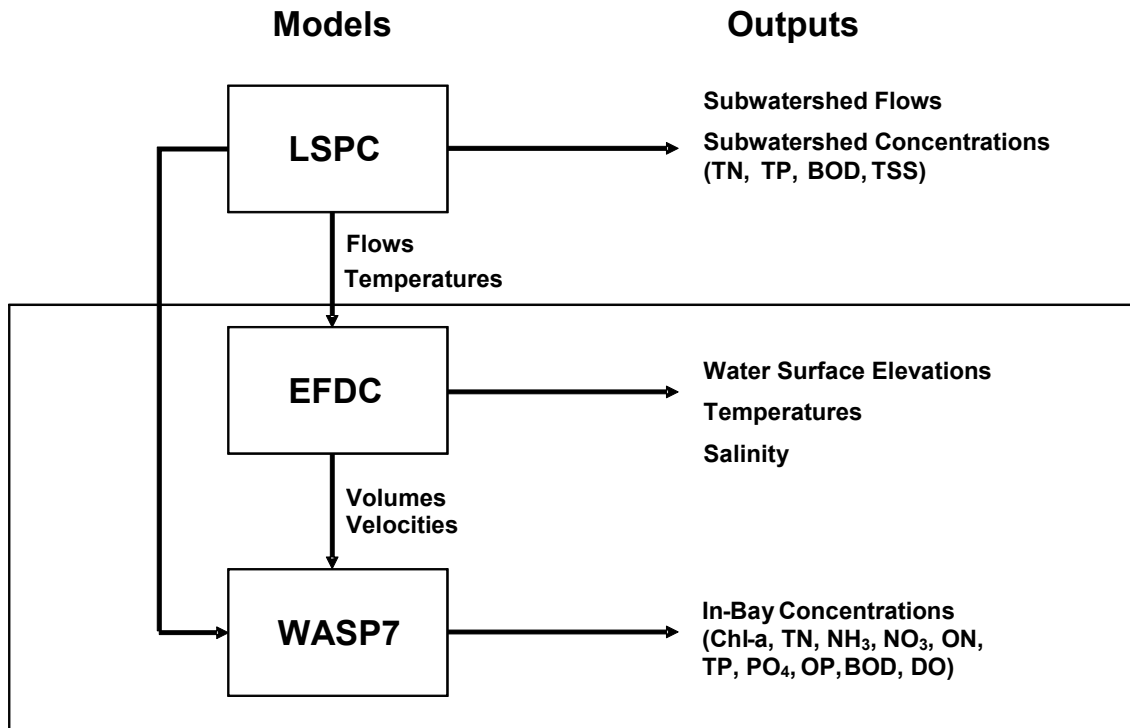

Note: For definition of abbreviations, see the text.

**Figure 5. Linkages among LSPC, EFDC, and WASP models used for helping describe hydrodynamic and water quality linkages of the Weeks Bay system.**

## 5 Monitoring and Empirical Modeling Report Summary

### 5.1 Overview

On the basis of our evaluation of water chemistry, especially salinity, we propose stratifying the bay into four site classes: (1) freshwater streams (less than 1 part per thousand [ppt]), (2) tidal streams (1–5 ppt), (3) mid-bay locations (5–12 ppt), (4) and out-bay station (Mobile Bay, more than 12 ppt). DO concentrations were consistently high in the freshwater areas, ranging from 6.3 to 9.6 mg/L. Tidal streams are affected by both the marine tidal and freshwater flow, thus having a wide range of salinity, in this data set measuring between 0–19.3 ppt. These stations also had a wide range of DO (0.3–14.6 mg/L) but pH values were usually greater than 7. Stations in Weeks Bay and Mobile Bay are mostly marine, although, low salinity (less than 5 ppt) was also observed occasionally, with occasional exceedance of the DO criterion in the mid-bay stations. Generally, water chemistry analyses demonstrated bayward (fresh to marine) increases in TOC, TP, and turbidity; and slight bayward decreases in TN, NO<sub>2+3</sub>, and chl *a*. An interesting note is that observed TP for the mainstem sites on the Fish River (FI-1 and FSHB-7) (Figure 4) was substantially higher than for the two tributary streams (PLCB-99 and CWPB-100).

Spatial and temporal variability of measures relevant to potential nutrient criteria, most particularly, DO and chl *a*, were excessive at times (Figure 6 and Figure 7), so it is critical to understand their variability to allow ecologically meaningful nutrient endpoints to be established. This study used two types of sampling to evaluate short-term (daily) and intermediate-term (monthly and seasonally) variability for Weeks Bay, including continuous and episodic.

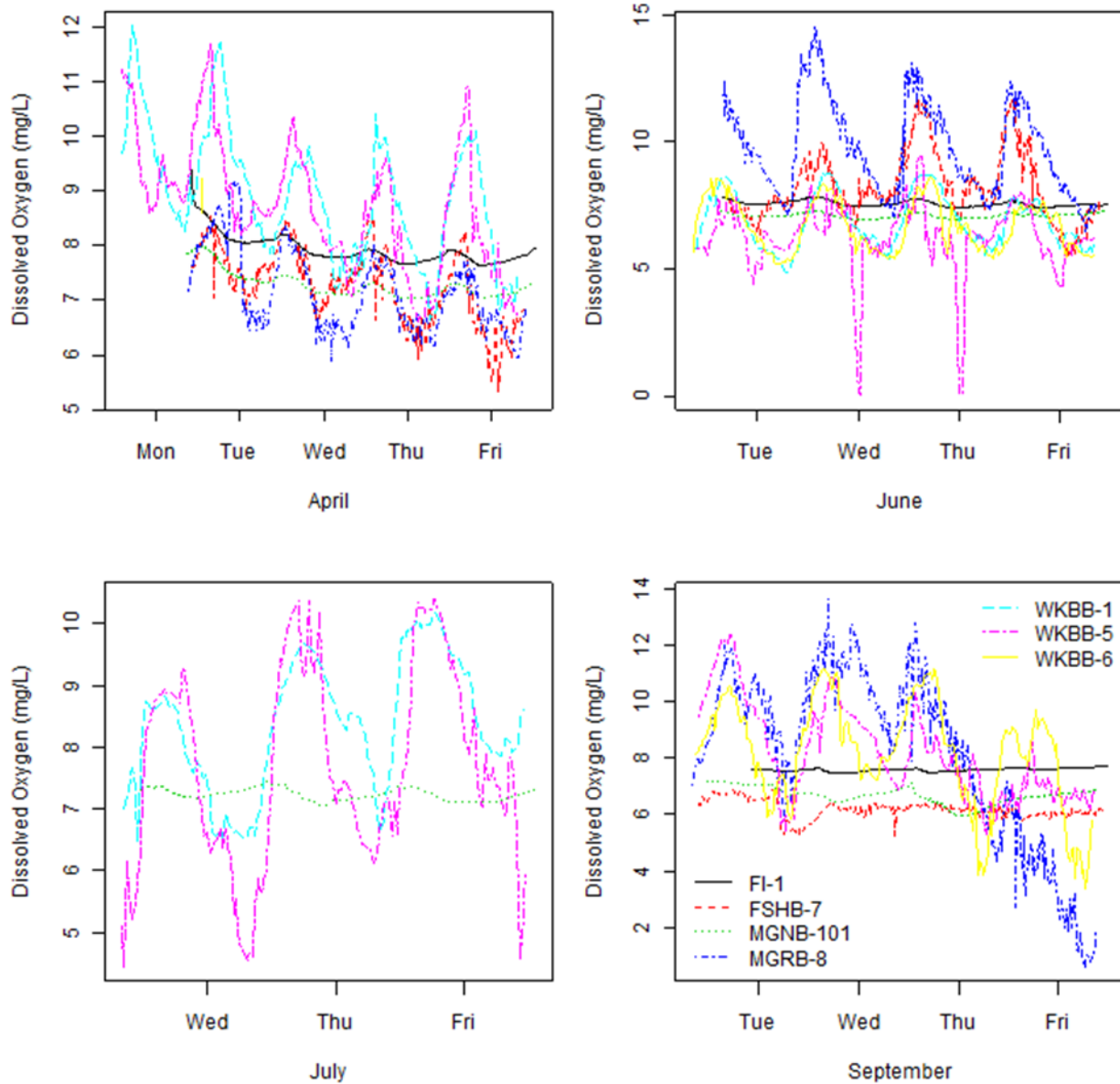

Note: Site locations: freshwater, FI-1 and MGNB-101; tidal streams, MGRB-8 and FSHB-7; mid-bay, WKBB.

**Figure 6. Continuous monitoring data showing DO fluctuation during four sampling events on April 17–20, June 13–17, July 5–8, and September 19–23.**

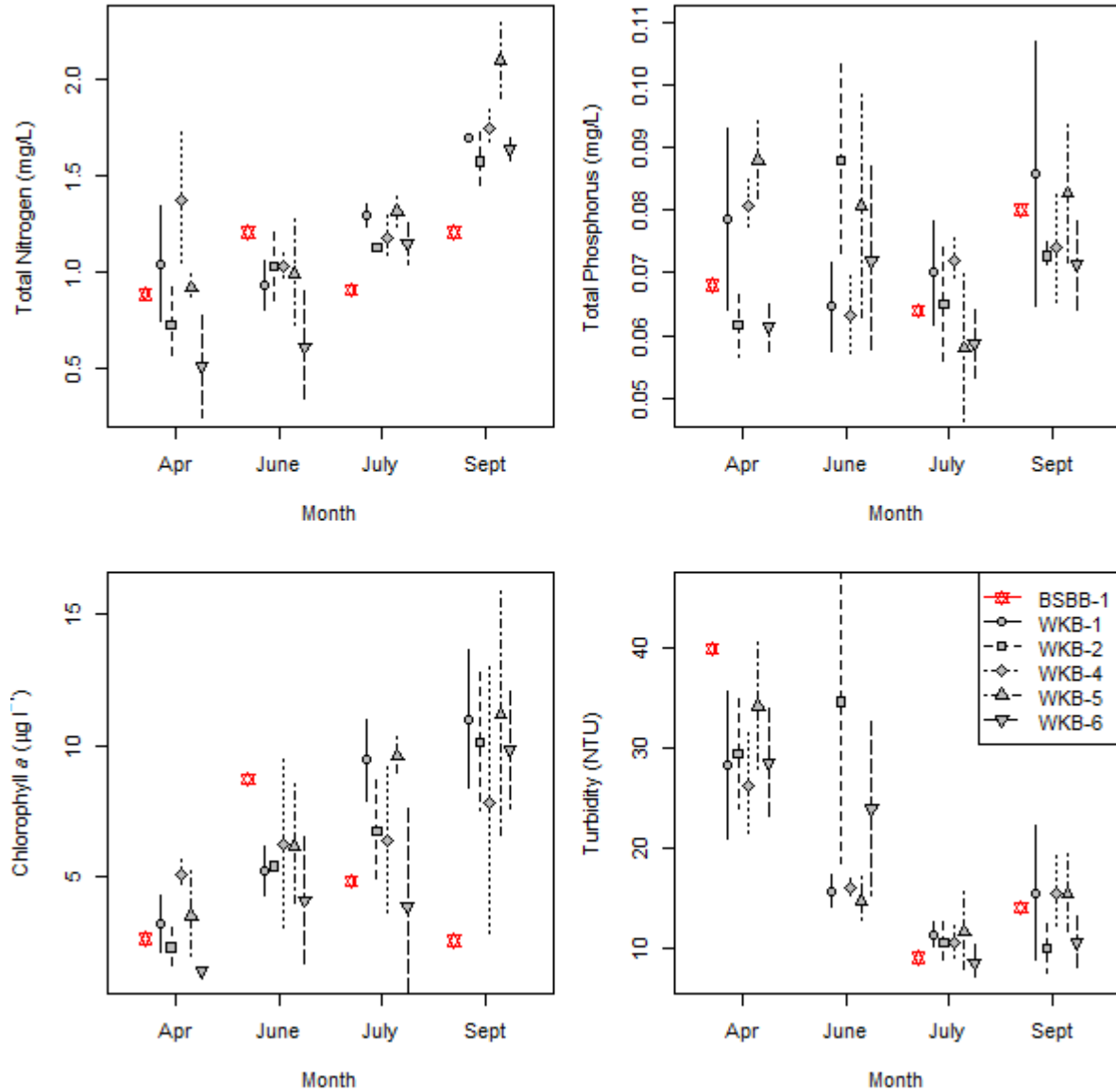

Note: Per sampling event, each site is represented by the mean and  $\pm 1$  standard deviation.

**Figure 7. Nutrient fluctuation during the four episodic nutrient survey periods in five mid-bay stations and one Mobile Bay station.**

## 5.2 Results Summary

The monitoring study and empirical analysis of the monitoring results and other Weeks Bay data led to several observations. Nutrient concentrations in the bay, especially near the Fish River inflow, were on the upper end of concentrations considered elevated or high for estuaries (Bricker et al. 2003) (Figure 8 and Figure 9). These were accompanied by episodic elevated chl *a* concentrations (Figure 10) and some anoxic and hypoxic DO concentrations (Figure 11).

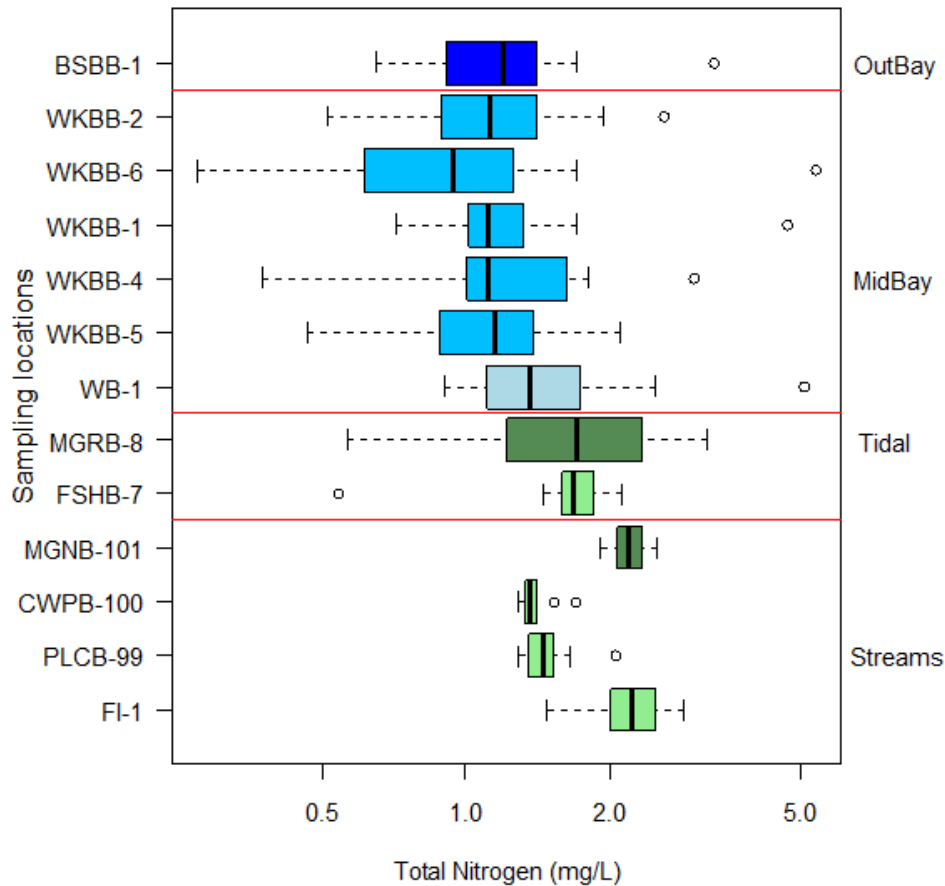

Note: Box colors: Fish River sites = light green; Magnolia River sites = dark green; mid-bay sites = light and modest blue; Mobile Bay sites = dark blue. Sampling stations are ordered top to bottom by increasing distance from the Mobile Bay station (BSBB-1). Each box represents the lower and upper quartiles and median values at each station; the whiskers extend to the most extreme data point, which is less than or equal to 1.5x the interquartile range from the box. The dots are the outliers, which are more than 1.5x the interquartile range.

**Figure 8. TN concentrations for 13 stations over the Weeks Bay system.**

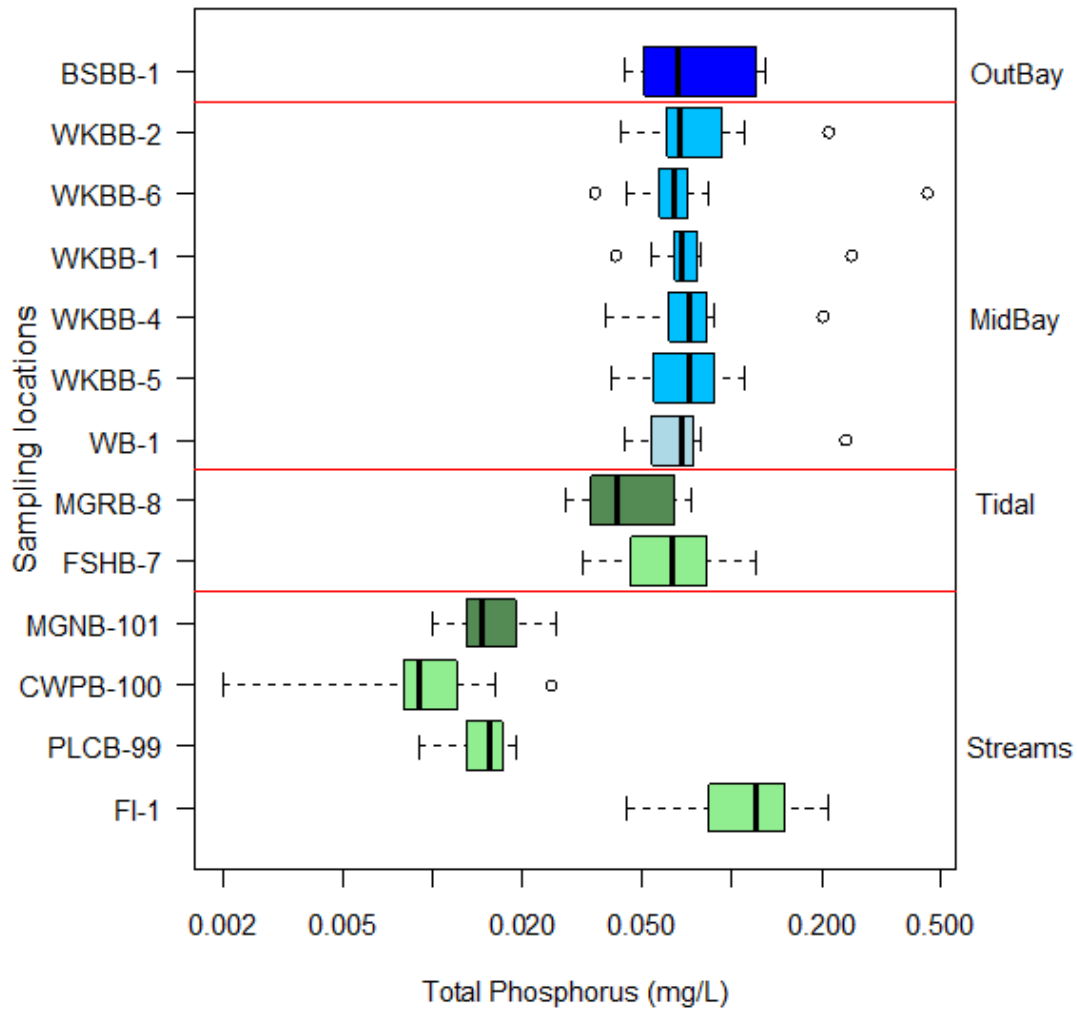

Note: Box colors: Fish River sites = light green; Magnolia River sites = dark green; mid-bay sites = light and modest blue; Mobile Bay sites = dark blue. Sampling stations are ordered top to bottom by increasing distance from the Mobile Bay station (BSBB-1). Each box represents the lower and upper quartiles and median values at each station; the whiskers extend to the most extreme data point, which is less than or equal to 1.5x the interquartile range from the box. The dots are the outliers, which are more than 1.5x the interquartile range.

**Figure 9. TP concentrations for 13 stations over the entire Weeks Bay system.**

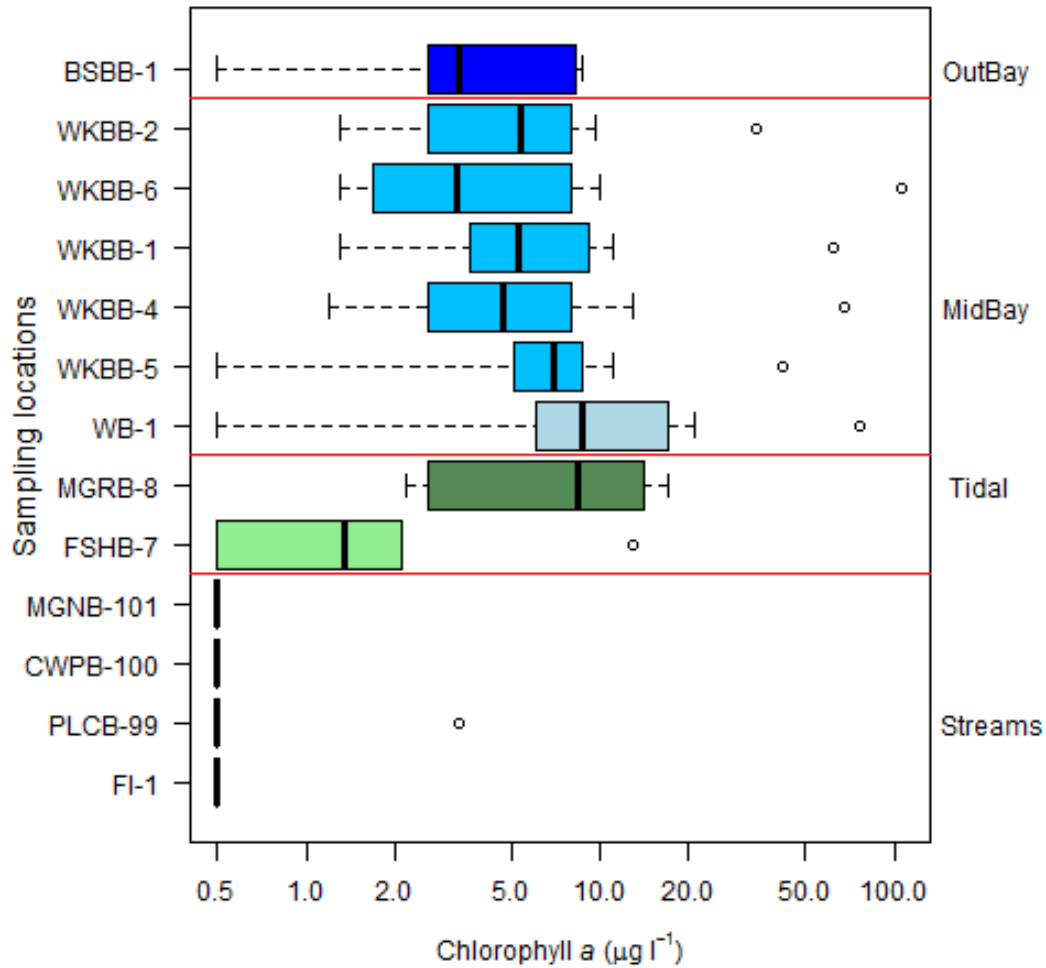

Note: Box colors: Fish River sites = light green; Magnolia River sites = dark green; mid-bay sites = light and modest blue; Mobile Bay sites = dark blue. Sampling stations are ordered top to bottom by increasing distance from the Mobile Bay station (BSBB-1). Each box represents the lower and upper quartiles and median values at each station; the whiskers extend to the most extreme data point, which is less than or equal to 1.5x the interquartile range from the box. The dots are the outliers, which are more than 1.5x the interquartile range.

**Figure 10. Chl a concentrations for 13 stations over the entire Weeks Bay system.**

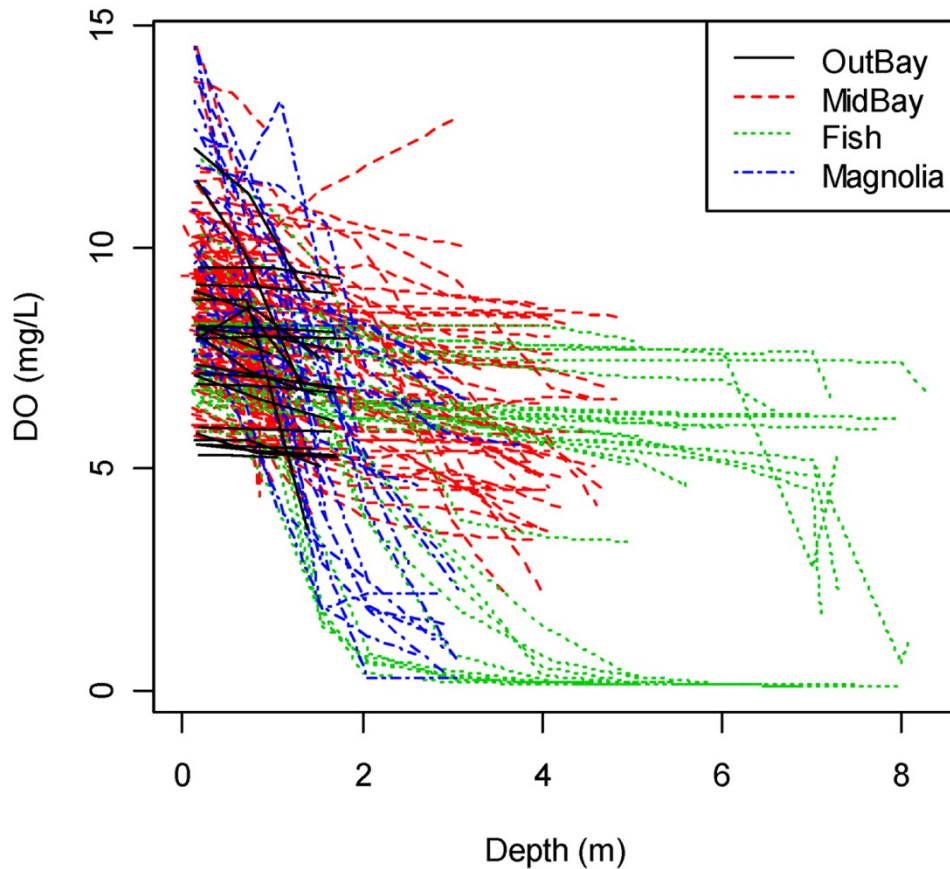

Note: One tidal station is also sampled in each of the Fish River and Magnolia River. The Fish River site is deepest of all locations, where the spring/summer data (March–August) are shown as flat lines and the fall data (September–November) as sharply declining with increasing depth.

**Figure 11. DO trends at different depths by sampling locations.**

Significant empirical relationships were found between chl *a* and nutrients, and these could be used to derive endpoints that could inform the selection of protective nutrient criteria. For example, chl *a* concentrations increased significantly with TN and TP concentrations across stations in the bay (Figure 12), and there was greater likelihood of average chl *a* concentrations above 9 ppb as nutrient concentrations increase, a concentration associated with more degraded benthic organism conditions and recommended from other studies (Bricker et al. 2003; Hagy et al. 2008). This same concentration, when converted into fluorometric chl *a* concentration, was also associated with increased DO flux and likelihood of DO minima less than 5 mg/L (Figure 13 and Figure 14). These chl *a* concentrations could then be related to TN and TP concentrations using the significant relationships between nutrients and chl *a* in Weeks Bay. Various regression modeling techniques place the TN concentrations associated with these chlorophyll endpoints at 1.4–1.7 mg/L and TP at 0.08–0.1 mg/L.



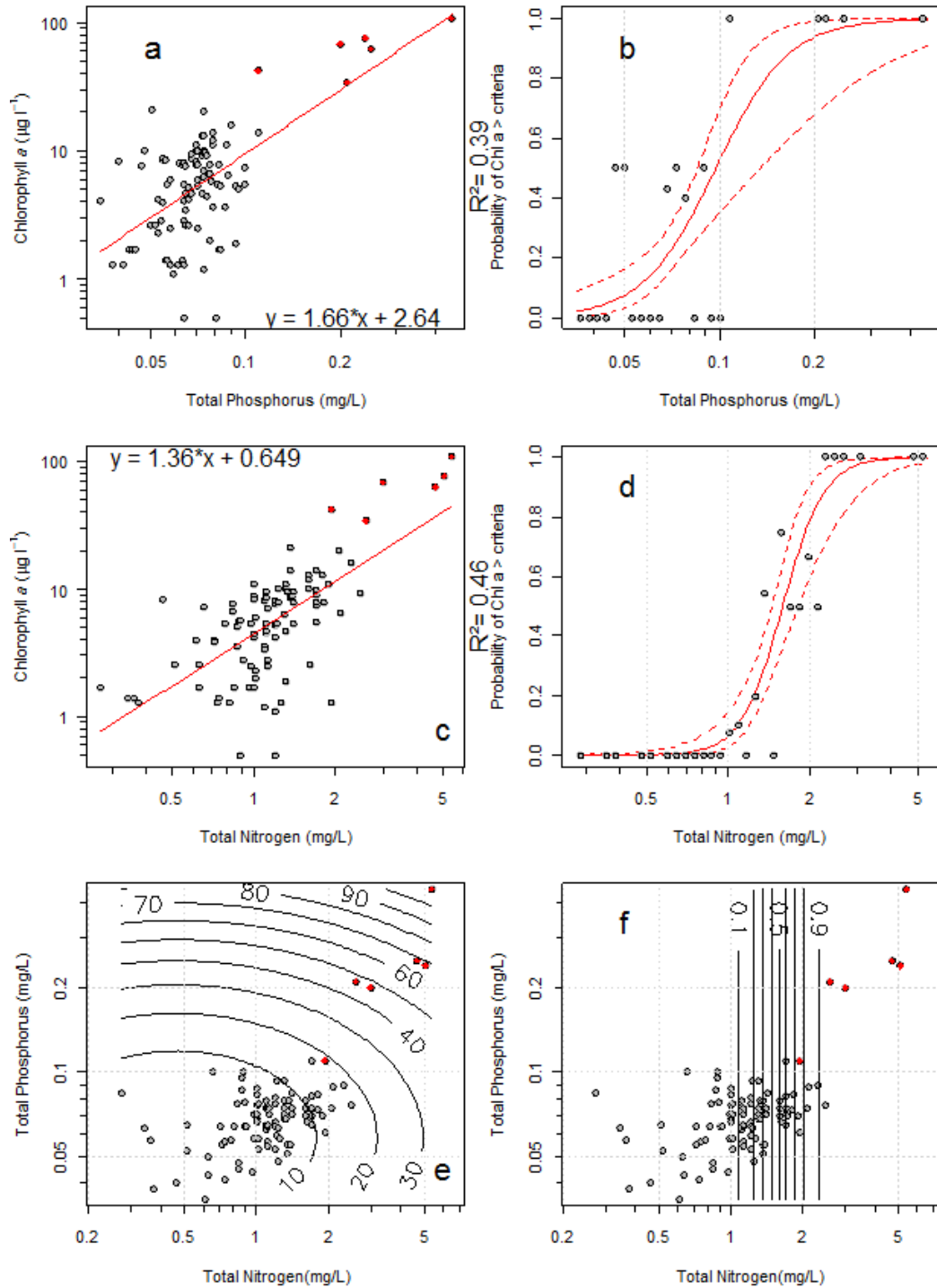

Note: Panels on the left show linear regression plots; the right column shows the logistic regression plots with probability of chl *a* greater than 10 µg/L as the response variable. The top two rows are single nutrient models, and the third row is the regression models based on both TN and TP as predictors. Red dots are samples collected in February.

**Figure 12. Relationships between chl *a* and TN and TP concentrations in Weeks Bay.**

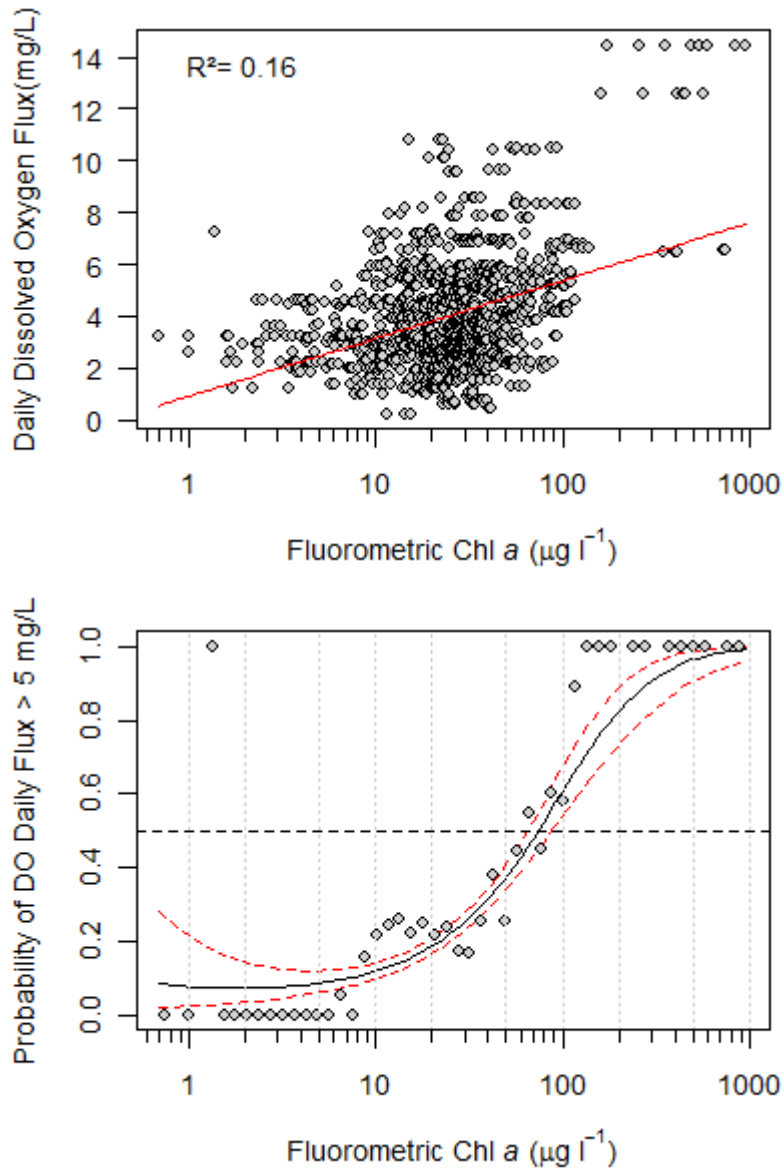
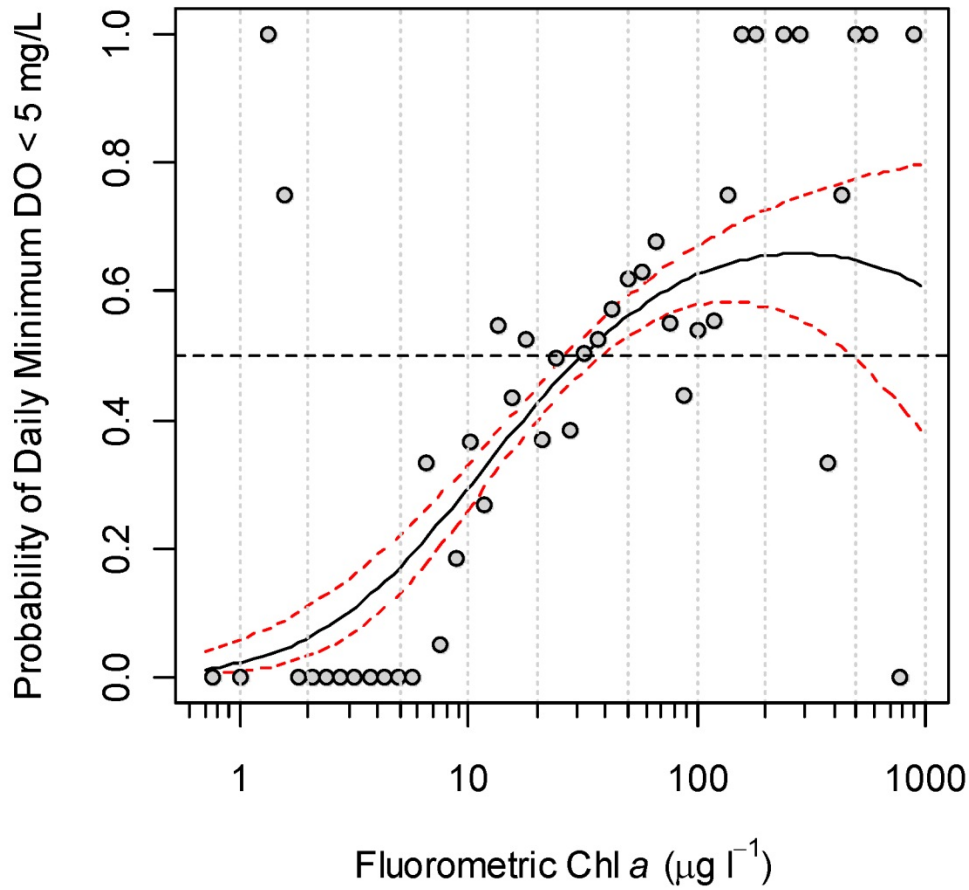

Figure 13. The relationship between DO daily fluctuation and chl a concentration in the water column.



Note: The fitted lines are the logistic regression fit with 90 percent confidence intervals. The dots are the mean probabilities in each equally distanced bin.

**Figure 14. The relative risk of daily minimum DO less than 5 mg/L with increasing chl a concentrations.**

## 6 Mechanistic Modeling Report Summary

### 6.1 Overview

A series of linked mechanistic models of Weeks Bay was developed to simulate the source, fate, transport, and effect of nutrients on the bay ecosystem (Appendix B). A watershed loading model (LSPC) to model water and nutrient inputs, a hydrodynamic model (EFDC) to model water and material movement, and a water quality model (WASP7) to simulate more than 14 water quality variables, were calibrated for this estuary and used to model three nutrient reduction scenarios: current condition, natural conditions, and 50 percent reduction.

### 6.2 Results Summary

Model performance was generally good. Salinity and temperature calibration goals were very good for 70 percent of the modeled site locations, and water quality calibration was very good or good for 91 percent of the variables evaluated across the different sites (Table 1).

Modeled chl *a* across the three scenarios indicated geometric mean and 90<sup>th</sup> percentile concentrations consistent with the empirical data (when converted to spectrophotometric estimates) and showed only modest response to reductions (Table 2).

**Table 1. General calibration/validation targets for EFDC/WASP7 applications**

State variable	% Difference between simulated and observed values		
	Very good	Good	Fair
Salinity	< 15%	15%–25%	25%–40%
Water temperature	< 7%	8%–12%	13%–18%
Water quality/D.O.	< 15%	15%–25%	25%–35%
Nutrients/chl <i>a</i>	< 30%	30%–45%	45%–60%

**Table 2. Surface phytoplankton biomass (90th percentile) in Weeks Bay**

Year	Photic zone phytoplankton (Chl <i>a</i> µg/L)		
	S1	S2	S3
2009	24.3	20.6	22.6
2010	20.6	18.4	19.7
2011	34.5	30.9	32.9
90th percentile	34.7	30.9	33.0

Note: Water column surface geometric mean phytoplankton biomass and 90th percentile in Weeks Bay each scenario from 2009 to 2011. Scenario 1 is existing conditions (S1), scenario 2 natural conditions (S2), and scenario 3 a 50 percent anthropogenic load reduction (S3).

Existing conditions were relatively supportive of existing criteria for DO and it appeared that load reductions would have only a moderate effect on response variables oxygen and chl *a* (Appendix B). The geometric mean annual estuarine TN, TP, and chl *a* concentrations were calculated from the model output

and used to estimate 90<sup>th</sup> percentiles of long-term annual means on the basis of the modeled period (2003–2011). These values indicate TN concentrations of 1.44 mg/L, TP of 0.07 mg/L, and chl *a* of 35 µg/L (fluorometric) under current conditions, fairly consistent with the empirical data.

**Table 3. 90<sup>th</sup> percentile long-term geometric mean TN, TP, and chl *a* concentrations in Weeks Bay**

	Nutrient load alternative scenarios		
	S1	S2	S3
TN (mg/L)	1.44	0.98	1.20
TP (mg/L)	0.070	0.053	0.062
Chl <i>a</i> (µg/l)	34.7	30.9	33.0

The TN, TP and chl *a* concentrations (again, when converted to spectrophotometric units) were consistent with recommended endpoints from the empirical analysis (0.08–0.1 mg/L for TP, 1.4 – 1.7 mg/L for TN, and 9 µg/L for chl *a*, respectively), although nutrient concentrations under existing and nutrient reduction scenarios were on the lower end of these ranges, or just below, and the natural conditions scenario was approximately 50% of the criteria ranges.

## 7 Summary and Recommendations

### 7.1 Protective Thresholds

Selecting protective endpoints relies somewhat on interpreting existing conditions in the estuary and interpreting the effect of the modeled scenarios. On one hand, observation data indicate that some existing conditions exhibit dynamics that are consistent with elevated nutrients (high chl *a* observations, low DO excursions, some affected benthic scores). On the other hand, reduction scenarios do not indicate reductions over existing conditions would reduce these adverse responses. This context and the uncertainty in both empirical and mechanistic modeling results make recommending specific endpoints difficult. The fact that existing conditions based on the model under existing loads and empirical modeled results to specific chl *a* and oxygen targets lead to similar endpoints, is somewhat encouraging. With this in mind, the recommendation of TP targets in the 0.08–0.10 mg/L annual geometric mean and TN targets in the 1.2–1.7 mg/L annual geometric mean seem reasonable and consistent, as do targets of summer geometric mean chl *a* in the 8–10 µg/L (spectrophotometric) or annual geometric mean in the 20–30 µg/L (fluorometric) range (Table 4). The upper values of the TN range to seem to be on the high end of concentrations described as high in the eutrophication assessment literature (Bricker et al. 2003). It is noteworthy that the Mobile Bay system is reported as being moderately eutrophic and susceptible to nitrogen enrichment in the National Estuarine Eutrophication Assessment (Bricker et al. 1999). Given the amount of agriculture in the catchment, the elevated nitrogen concentrations, and the trends of increasing nitrogen and phosphorus concentrations over the past 8 years, existing conditions might be contributing to excess nitrogen loading and, while perhaps supportive of an existing condition target, nutrient reductions should be encouraged, nitrogen and phosphorus reductions expected, and responses monitored to inform future thresholds modifications. It might also suggest the lower end of the recommended target range would be more appropriate.

**Table 4. Suggested nutrient and chlorophyll water quality thresholds for Weeks Bay, Alabama, resulting from the weight-of-evidence approach based on empirical and mechanistic modeling results**

Variable	Threshold recommendation
TN	Annual geometric mean 1.2–1.7 mg/L
TP	Annual geometric mean 0.08–0.10 mg/L
Chl <i>a</i>	Summer geometric mean 8–10 ug/L (spectrophotometric) Annual geometric mean 20–30 ug/L (fluorometric)

Note: Values should be interpreted as the duration and magnitudes given. Frequencies should be interpreted as not to exceed or to exceed only infrequently. Spatial averaging could be used, but these are intended to be applied to each site.

## 7.2 Monitoring Design

The monitoring performed over the past year provided a rich data set enabling a better understanding of spatial and temporal variations of nutrient concentrations and inflow/outflow to and from the Weeks Bay system. However, the data set represents only one year, which, according to the spatial and temporal complexity of the watershed, provides only a beginning to understanding interannual consistency. The observed stressor-response relationship in the current data set represents only a limited linkage between TN and elevated chl *a* concentrations in the bay. More extensive data collections are needed to better understand the dynamics of nutrient spikes in Weeks Bay.

The sampling design behind this data set provided a clear picture of nutrient and other water quality characteristics in the Weeks Bay watershed. We recommend using results of this study to inform future/longer term monitoring designs for Weeks Bay and for other Gulf of Mexico inland estuaries. Suggestions are the following:

1. Incorporate with existing NERRS study. The existing long-term monitoring effort by NERRS offers an excellent opportunity for analyzing long-term dynamics of DO, salinity, and other environmental variables in the Weeks Bay system. Future monitoring should use existing data and provide complementary effort to better characterize nutrient conditions in the bay. One of the best uses of the NERRS data set is to provide comparable chl *a* measurements at similar or same locations. Also, future monitoring should provide additional variable monitoring that NERRS does not now offer, e.g., TKN, TP, TOC, or CBOD.
2. Conduct a multiple-year study. The pattern shown from current analysis indicated that temporal variability is far greater than spatial (within bay) variability. Longer term monitoring is needed to better capture that variability across the range of environmental gradients. Although NERRS data provided valuable information on long-term variability, the incomparability of the data with current monitoring efforts makes it difficult to confirm the pattern observed from this study. At least 3 years of monitoring data are needed to provide better confidence in statistical assumptions.
3. Increase the frequency of biological monitoring. This study judges biological condition at locations on the basis of a single benthic sample. Because of the small size of Weeks Bay, it would be useful and informative to take future benthic samples from at least the four stations where NERRS is conducting continuous monitoring. This would target those sites for annual sampling over multiple years and would contribute to better understanding the nature and effects of nutrient input from the two principal freshwater inflows and from Mobile Bay proper.
4. Reduce the scale of the overall monitoring effort. Freshwater streams had relatively constant water quality conditions observed in 2011, and, thus, the measurement/sampling frequency for many of the parameters could be reduced to help save budgetary resources. Also, instead of three sites on the Fish River, sufficient data would be produced from one site placed on the mainstem,

upstream of tidal influence and downstream of the confluence of the tributaries, preserving additional resources. For water chemistry and chl *a*, future sampling could be done and would be sufficient at upper wadeable streams (two sites), tidal streams (two sites), mid-bay (five sites), and one in Mobile Bay itself (eight sites total).

5. Reduce sampling events. Several sampling events could be dropped if future monitoring is conducted. Episodic nutrient surveys and sonde continuous monitoring provides valuable information on daily fluctuations of environmental parameters. This information has been recorded by NERRS, so future monitoring should focus more resources on monthly changes.
6. Reduce the number of parameters and increase consistency. For purposes of investigating nutrient dynamics, several water quality parameters could be dropped from the monitoring activities. Substantial redundancy exists among alkalinity, hardness, conductivity, chloride, and TDS; they are all salinity-related parameters. Measuring them all individually provides only minimal additional interpretive strength related to nutrients. Because of the existing long-term data set of the NERRS/CDMO for chl *a*, future monitoring should use the fluorometric method, but reconciliation with ADEM monitoring methods are necessary to provide a linkage. Whichever method is chosen, the criterion would need to be expressed explicitly in those units.

In summary, the monitoring study (Appendix A), along with NERRS long-term monitoring effort, provides solid background information for understanding nutrient dynamics in the Weeks Bay system. However, studies should be conducted to further support the causal relationship between nutrient input from upstream sources, resulting algal blooms in Weeks Bay, and effects on higher trophic levels (such as the benthic invertebrates). These studies would enhance the scientific defensibility of nutrient criteria.

### 7.3 Modeling

As a result of the modeling efforts (Appendix B), much was learned about the Weeks Bay system and much identified that has yet to be learned. Summary points and suggestions are the following:

- 1 The LSPC-EFDC-WASP complex of models is a well-suited tool for simulating the cause-and-effect relationship between the pollutants of concern (TN and TP) and chl *a*, water clarity and DO as the selected response parameters or endpoints in Weeks Bay. The specified values of the response parameters can serve as the targets for numerical nutrient criteria.
- 2 The models consider basic hydrologic, chemical, and biological processes, and input of meteorological factors in Weeks Bay and input of point and nonpoint sources of pollution from the contributing watersheds.
- 3 The time variable, three-dimensional system of hydrodynamic and water quality models of Weeks Bay was calibrated and validated with data collected by ADEM, NERRS, EPA and NOAA in a period spanning from 2008 to 2011.
- 4 The calibrated EFDC-based hydrodynamic model represents the overall circulation and mixing characteristics of the Weeks Bay system based on reasonably good agreement between observed and calculated temporal and spatial distributions of water surface elevations, salinity, and temperature.
- 5 The calibrated WASP-based water quality model reasonably represents the overall phytoplankton, nutrient and DO interactions in the Weeks Bay system. The water quality simulations show reasonably good agreement with continuous and monthly observed data.
- 6 Nutrient loading scenarios were selected to evaluate the effects of nutrient load reductions on the aforementioned endpoints in Weeks Bay. The scenarios are S1 - existing loads, S2 - no

anthropogenic loads, and S3 - a 50 percent reduction of anthropogenic loads. The scenarios S1 and S2 presumably represent current and lowest possible levels; S3 presents an example of an intermediate level of loading.

- 7 ADEM will define final numeric criteria for Weeks Bay. The modeling results can be used to both inform that process and to help determine the nutrient reductions necessary to meet the desired endpoint values if necessary.
- 8 Analysis of outputs of loading scenarios allowed estimation of sensitivity of the Weeks Bay endpoints to anthropogenic nutrient loads. For the scenario with no anthropogenic part of the nutrient load, the primary production rate declined by 27 percent. The correspondent change for the 90th percentile of chl *a* was 13 percent. Light extinction coefficient showed low sensitivity to phytoplankton concentrations. The major part of the light attenuation appeared to be due to colored waters and TSS. DO did not meet the Alabama DO criteria in 8.1 percent, 10.4 percent and 9.1 percent of the observations for the 2009–2011 period for scenarios S1, S2 and S3, respectively. Decreasing phytoplankton biomass with reduction of nutrients loadings lead to decreasing oxygen production with photosynthesis and a small decrease in oxygen concentrations in the middle layer of the bay.
- 9 Updating the simulation scenarios by including relationships that connect reduction of the nutrient loads with the reduction of the river boundary values of phytoplankton and sediment oxygen demand would significantly increase the model sensitivity and response to the nutrient loading.
- 10 We recommend adding a fourth scenario looking at a 150 percent anthropogenic load scenario to increase the gradient for evaluating modeled nutrient loads versus response condition. Results of this modeling would inform whether current conditions are at an assimilative maximum or whether increased loadings would continue to exacerbate empirically-observed, adverse responses to nutrient enrichment.



## 8 References

- Barnes, R.S.K., and R.N. Hughes. 1988. *An Introduction to Marine Ecology*. Blackwell, Boston, MA.
- Boesch, D.F. 2002. Challenges and opportunities for science in reducing nutrient over-enrichment of coastal ecosystems. *Estuaries* 25(4b):886–900.
- Bricker, S.B., C.G. Clement, D.E. Pirhalla, S.P. Orlando, and D.R.G. Farrow. 1999. National Estuarine Eutrophication Assessment: Effects of Nutrient Enrichment in the Nation’s Estuaries. NOAA, National Ocean Service, Special Projects Office and the National Centers for Coastal Ocean Science. Silver Spring, MD.
- Bricker, S.B., J.G. Ferreira, and T. Simas. 2003. An integrated methodology for assessment of estuarine trophic status. *Ecological Modelling* 169:39–60. doi:10.1016/S0304-3800(03)00199-6.
- Conley, D.J., H.W. Paerl, R.W. Howarth, D.F. Boesch, S.P. Seitzinger, K.E. Havens, C. Lancelot, and G.E. Likens. 2009. Controlling eutrophication: Nitrogen and phosphorus. *Science* 323:1014–1015. doi:10.1126/science.1167755.
- Diaz, R.J., and R. Rosenberg. 2008. Spreading dead zones and consequences for marine ecosystems. *Science* 321: 926-929. doi:10.1126/science.1156401.
- Duarte, C.M. 2009. Coastal eutrophication research: A new awareness. *Hydrobiologia* 629:263–269. doi:10.1007/s10750-009-9795-8.
- GOMA (Gulf of Mexico Alliance). 2009a. *Governors’ Action Plan II. For Resilient and Healthy Coasts. 2009-2014*. Gulf of Mexico Alliance. <http://www.gulfofmexicoalliance.org/index.php>.
- GOMA (Gulf of Mexico Alliance). 2009b. *Nutrient Criteria Research Framework* (draft for comments). Gulf of Mexico Alliance, Nutrients Priority Issues Team. [http://www.gulfofmexicoalliance.org/working/nutrients/ncrf\\_draft\\_0509.pdf](http://www.gulfofmexicoalliance.org/working/nutrients/ncrf_draft_0509.pdf).
- Griffith, G.E., J.M. Omernik, J.A. Comstock, S. Lawrence, G. Martin, A. Goddard, V.J. Hulcher, and T. Foster. 2001. Ecoregions of Alabama and Georgia, (color poster with map, descriptive text, summary tables, and photographs), map scale 1:1,700,000. U.S. Geological Survey Reston, VA. Accessed March 15, 2013. [http://www.epa.gov/wed/pages/ecoregions/alga\\_eco.htm](http://www.epa.gov/wed/pages/ecoregions/alga_eco.htm).
- Hagy, J.D., J.C. Kurtz, and R.M. Greene. 2008. *An approach for developing numeric nutrient criteria for a Gulf coast estuary*. EPA 600R-08/004. U.S. Environmental Protection Agency, Office of Research and Development, National Health and Environmental Effects Research Laboratory, Research Triangle Park, NC.
- Halpern, B.S., S. Walbridge, K.A. Selkoe, C.V. Kappel, F. Micheli, C. D’Agrosa, J.F. Bruno, K.S. Casey, C. Ebert, H.E. Fox, R. Fujita, D. Heinemann, H.S. Lenihan, E.M.P. Madin, M.T. Perry, E.R. Selig, M. Spalding, R. Steneck, and R. Watson. 2008. A global map of human impact on marine ecosystems. *Science* 319:948-952. doi:10.1126/science.1149345.
- Howarth, R.W. 2008. Coastal nitrogen pollution: A review of sources and trends globally and regionally. *Harmful Algae* 8:14–20.
- Lehrter, J.C. 2008. Regulation of eutrophication susceptibility in oligohaline regions of a northern Gulf of Mexico estuary, Mobile Bay, Alabama. *Marine Pollution Bulletin* 56:1446–1460

- Li, W.K.W., M.R. Lewis, W.G. Harrison. 2008. Multiscalarity of the nutrient–chlorophyll relationship in coastal phytoplankton. *Estuaries and Coasts* 33(2):440–447. doi:10.1007/s12237-008-9119-7.
- Lotze, H.K., H.S. Lenihan, B.J. Bourque, R.H. Bradbury, R.G. Cooke, M.C. Kay, S.M. Kidwell, M.X. Kirby, C.H. Peterson, and J.B.C. Jackson. 2008. Depletion, degradation, and recovery potential of estuaries and coastal seas. *Science* 312:1806–1809. doi:10.1126/science.1128035.
- Miller-Way, T., M. Dardeau, and G. Crozier. 1996. *Weeks Bay National Estuarine Research Reserve: An Estuarine Profile and Bibliography*. Dauphin Island Sea Lab Technical Report 96-01. Dauphin Island, AL.
- Mitsch, W.J., J.W. Day Jr., J.W. Gilliam, P.M. Groffman, D.L. Hey, G.W. Randall, and N. Wang. 2001. Reducing nitrogen loading to the Gulf of Mexico from the Mississippi River Basin: Strategies to counter a persistent ecological problem. *BioScience* 51:373–388.
- Morrison, A.G. 2011. *Spatial and Temporal Trends and the Role of Land Use/Cover on Water Quality and Hydrology in the Fish River Watershed*. Masters thesis. Auburn University, Auburn, AL.
- NOAA (National Oceanographic and Atmospheric Administration). 2012. National Geophysical Data Center, National Oceanic and Atmospheric Administration, Silver Spring, MD. Accessed March 19, 2013. <http://www.ngdc.noaa.gov/mgg/bathymetry/relief.html>.
- NOAA (National Oceanic and Atmospheric Administration). 2013a. National Estuarine Research Reserve System (NERRS). National Oceanic and Atmospheric Administration, National Ocean Service, Ocean and Coastal Resource Management. Accessed March 14, 2013 <http://www.nerrs.noaa.gov/>.
- NOAA (National Oceanic and Atmospheric Administration). 2013b. *Weeks Bay*. National Estuarine Research Reserve System. National Oceanic and Atmospheric Administration, Silver Spring, Maryland. Accessed March 19, 2013. <http://www.nerrs.noaa.gov/Reserve.aspx?ResID=WKB>.
- NOAA (National Oceanographic and Atmospheric Administration). 2013c. Tides and currents. Accessed March 19, 2013. <http://tidesandcurrents.noaa.gov/>.
- O’Neil, P.E., and R.V. Chandler. 2003. *Water Quality and Biological Monitoring in Weeks Bay Watershed, Alabama*. Water Investigations Program Bulletin 173. Geological Survey of Alabama, Tuscaloosa, AL.
- Rabalais, N. 2002. Nitrogen in aquatic ecosystems. *Ambio* 31(2):102–112.
- Schlesinger, W.H. 1997. *Biogeochemistry: An Analysis of Global Change*. Academic Press, New York.
- USEPA (U.S. Environmental Protection Agency). 1998. *National Strategy for the Development of Regional Nutrient Criteria*. EPA-822-R-98-002. U.S. Environmental Protection Agency, Office of Water, Washington, DC.
- USEPA (U.S. Environmental Protection Agency). 2000. *Ambient Water Quality Criteria Recommendations: Information Supporting the Development of State and Tribal Nutrient Criteria: Rivers and Streams in Nutrient Ecoregion IX*. EPA-822-B-00-019. U.S. Environmental Protection Agency, Office of Water, Washington, DC.

USEPA (U.S. Environmental Protection Agency). 2001. *Nutrient Criteria Technical Guidance Manual: Estuarine and Coastal Marine Waters*. EPA-822-B-01-003. U.S. Environmental Protection Agency, Office of Water, Washington, DC.

Weeks Bay NERR. 2007. Weeks Bay National Estuarine Research Reserve Management Plan.  
<http://nerrs.noaa.gov/WeeksBay/welcome.html>.



*Appendix A*

*Empirical Analysis of Monitoring Results for  
Weeks Bay, Alabama*



# Sources, Fate, Transport, and Effects (SFTE) of Nutrients as a Basis for Protective Criteria in Estuarine and Near-Coastal Waters

## Weeks Bay, Alabama Pilot Study Empirical Analysis of Monitoring Results



Prepared for:



The Gulf of Mexico Alliance  
1141 Bayview Avenue  
Biloxi, MS 39530

Under the direction of:



1400 Coliseum Boulevard  
Montgomery, AL 36110



515 Amite Street  
Jackson, MS 39201

March 29, 2013





# **Sources, Fate, Transport, and Effects (SFTE) of Nutrients as a Basis for Protective Criteria in Estuarine and Near-Coastal Waters**

## **Weeks Bay, Alabama Pilot Study**

### *Empirical Analysis of Monitoring Results*

*Prepared for*

The Gulf of Mexico Alliance (GOMA)  
1141 Bayview Avenue  
Biloxi, MS 39530

*Under the direction of*

Alabama Department of Environmental Management,  
Water Quality Branch, 1400 Coliseum Boulevard,  
Montgomery, AL 36110

*and*

Mississippi Department of Environmental Quality,  
Office of Pollution Control, 515 Amite Street,  
Jackson, MS 39201

*Prepared by*

Tetra Tech, Inc., 400 Red Brook Boulevard, Suite 200  
Owings Mills, MD 21117-5172

March 29, 2013

## **Abstract**

The Weeks Bay estuary system is a sub-estuary (607 km<sup>2</sup>) of Mobile Bay (Alabama) representing transitional characteristics from freshwater wadeable streams, non-wadeable tidal rivers, to a marine estuary. Two major rivers, Fish River and Magnolia River, provide the principal freshwater inflows to Weeks Bay system, and are typical blackwater streams with low pH and planktonic productivity. Nutrient loadings from the two watersheds are very different, with both high TP and TN loadings from the Fish River, and lower TP loading for the Magnolia River. The tidal portions of the rivers are heavily influenced by both fresh and marine (low N and high P) water. Stations within the bay also show different water quality and biological characteristics (benthic invertebrates) with locations closer to the Fish River potentially biologically degraded, while stations in the rest of bay are rated as non-degraded. The distinct characteristics among different water bodies also vary strongly at temporal scale. Increased frequency of oxygen depletion (> 50% below 5 mg/L D.O.) at the mouth of Fish River during summer, a potential cause of biological degradation, could be due to rising temperature, nutrient concentrations and resultant increases in phytoplankton biomass. Nutrient criteria for Weeks Bay could be developed from the monitoring dataset on existing conditions in the bay, to protect from excessive nutrient loadings in the watersheds.

## Acknowledgments

This project was funded by the National Oceanic and Atmospheric Administration (NOAA) through a grant to the Mississippi Department of Environmental Quality (MDEQ) (no. NA08NOS4730395). As the lead member agency for the Nutrients Priority Issues Team within Gulf of Mexico Alliance (GOMA), the Mississippi Department of Environmental Quality (MDEQ) administered the project as Work Order no. 11-00107TT-01 to Tetra Tech, Inc. (as part of contractual agreement no. 11-00107). The Alabama Department of Environmental Management (ADEM) was the client lead for all technical and procedural issues.

The primary authors are Lei Zheng and James Stribling (Tetra Tech, Inc., Owings Mills, MD). They were assisted through discussion and document reviews by Michael Paul and Jeroen Gerritsen (Tetra Tech-Owings Mills [MD]). ADEM staff participating in project planning and conducting fieldwork included Jeff Davies, Gary McCord, Suzi Rice, Steve Summersell, Fred Leslie, Michael Len, James Worley, Brian Haigler, Charles Reynolds, David Thompson, Jennifer Haslbauer, Jason Wilkins, and Ross Caton. Personnel with the Weeks Bay National Estuarine Research Reserve (NERR) who participated in project planning included Dr. Scott Phipps and L.G. Adams.

Laboratory analytical chemistry was performed by the ADEM Water Quality Laboratory in Montgomery, AL, and by the USEPA SEDS, in Athens, GA. Primary processing (sorting and taxonomic identification) of the benthic invertebrate samples was done by Dr. Jerry McLelland (Gulf Benthic Taxonomy Assessment, Ocean Springs, MS), and quality control (QC) taxonomy was by Dr. Carey Gelpi (Louisiana State University, Baton Rouge, LA). Ms. Carolina Gallardo performed the QC sort rechecks and data entry, and Mr. Erik Leppo did all metric calculations.

Technical overview, document reviews were provided by Mr. Lynn Sisk and Mr. Chris Johnson (ADEM-Water Division-Water Quality Branch), Mr. Fred Leslie (ADEM-Field Operations Division), Ms. Kim Caviness (MDEQ-Water Quality Standards and Special Projects Branch), Ms. Kay Whittington (MDEQ-Watershed Management Branch). Kay Whittington was the MDEQ project manager, Ann Porter was the GOMA Nutrient PIT coordinator, and Mr. Ray Montgomery was overall contracts manager.

Proper citation of this report:

GOMA. 2013. *Sources, Fate, Transport, and Effects (SFTE) of Nutrients as a Basis for Protective Criteria in Estuarine and Near-Coastal Waters. Weeks Bay, Alabama Pilot Study. Empirical Analysis of Monitoring Results*. Prepared for: the Gulf of Mexico Alliance, Nutrients Priority Issues Team (Alabama Department of Environmental Management, and the Mississippi Department of Environmental Quality). Prepared by: Tetra Tech, Inc., Owings Mills, MD.

For further information, contact Mr. Lynn Sisk ([334] 271-7826, or [LS@adem.state.al.us](mailto:LS@adem.state.al.us)), Ms. Kim Caviness ([601] 961-5390, or [kim\\_caviness@deq.state.ms.us](mailto:kim_caviness@deq.state.ms.us)), or Ms. Kay Whittington ([601] 961-5729, or [kay\\_whittington@deq.state.ms.us](mailto:kay_whittington@deq.state.ms.us)).

## Contents

1	Introduction .....	A-1
2	Monitoring Design and Data Sets.....	A-2
3	Basic Water Quality Characteristics.....	A-5
4	Site Classification.....	A-5
5	Spatial Variations of Nutrient Concentrations in the Weeks Bay System.....	A-8
5.1	Total Organic Carbon Concentrations (TOC).....	A-8
	Total Nitrogen (TN).....	A-9
5.2	Nitrate-Nitrite (NO <sub>2</sub> +3-N) .....	A-10
5.3	Total Phosphorus (TP) .....	A-11
5.4	Chlorophyll a (Chl a).....	A-12
5.5	Turbidity.....	A-13
5.6	Total Suspended Solids (TSS).....	A-15
6	Spatial and Temporal Variation in the Bay .....	A-16
6.1	Short-Term Variation .....	A-16
	Continuous Monitoring of Water Quality Parameters .....	A-16
	Episodic Nutrient Surveys .....	A-21
6.2	Monthly Variation of Water Quality Parameters .....	A-26
6.3	Long-Term Continuous Monitoring.....	A-32
	Meteorological Conditions.....	A-32
	DO Fluctuation.....	A-32
	Salinity Fluctuation.....	A-37
	Turbidity Fluctuation .....	A-37
	Nutrient Fluctuation .....	A-37
6.4	Spatial Variation: Vertical Profile.....	A-45
7	Stressor-Response Relationships in the Mid-Bay .....	A-46
7.1	Correlations among Nutrient Parameters .....	A-46
7.2	Relationship between DO and Chl a in the Mid-Bay.....	A-47
7.3	Relationships between Chl a and TN and TP Concentrations.....	A-50
	Hierarchical Modeling .....	A-50
7.4	Biological Assessment of Benthic Condition in the Mid-Bay .....	A-52
8	Proposed Nutrient Criteria for Mid-Bay Locations.....	A-54
8.1	DO Criterion.....	A-54
8.2	Chl a Criterion.....	A-58
8.3	TN and TP Criteria.....	A-60
	Reference Approach.....	A-60
	Regression Models.....	A-61

9 Summary ..... A-61  
10 Recommendations ..... A-63  
11 Literature Cited..... A-65  
Attachment: Taxonomic Data Quality Control Report

## Tables

Table 1. Thirteen sampling locations for the Weeks Bay nutrient criteria pilot project (also see Figure 1). .....	A-4
Table 2. Summary statistics of environmental variables measured in the 13 sampling stations .....	A-5
Table 3. Median values (and ranges) of environmental variables measured at 13 sampling locations.....	A-7
Table 4. BIBI scores at six sampling locations.....	A-53
Table 5. Spearman correlations between BIBI scores and environmental variables .....	A-54
Table 6. Summary of daily DO minima and frequencies when daily DO minima are less than 2, 3, and 4 mg/L in NERRS data set.....	A-56

## Figures

Figure 1. Sampling sites used for the Weeks Bay SFTE nutrient criteria pilot study.....	A-3
Figure 2. Surface salinity for 13 stations in the Weeks Bay watershed.....	A-6
Figure 3 TOC for 13 stations over the entire Weeks Bay system.....	A-8
Figure 4. TN concentrations for 13 stations over the Weeks Bay system.....	A-9
Figure 5. NO <sub>2+3</sub> -N concentrations for 13 stations over the Weeks Bay system.....	A-10
Figure 6. TP concentrations for 13 stations over the entire Weeks Bay system.....	A-11
Figure 7. Chl <i>a</i> concentrations for 13 stations over the entire Weeks Bay system.....	A-12
Figure 8. Turbidity for 13 stations over the entire Weeks Bay system.....	A-13
Figure 9. Secchi Depth in nine stations over the entire Weeks Bay system.....	A-14
Figure 10. TSS in 13 stations over the Weeks Bay system.....	A-15
Figure 11. Continuous monitoring data showing water temperature fluctuation during four sampling events on April 17–20, June 13–17, July 5–8, and September 19–23.....	A-17
Figure 12. Continuous monitoring data showing pH fluctuation during four sampling events on April 17–20, June 13–17, July 5–8, and September 19–23.....	A-18
Figure 13. Continuous monitoring data showing conductivity fluctuation during four sampling events on April 17–20, June 13–17, July 5–8, and September 19–23.....	A-19
Figure 14. Continuous monitoring data showing DO fluctuation during four sampling events on April 17–20, June 13–17, July 5–8, and September 19–23.....	A-20
Figure 15. Nutrient fluctuation during the four episodic nutrient survey periods in five mid-bay stations and one Mobile Bay station.....	A-22
Figure 16. Comparisons of nutrient parameters in the mid-bay during ebb and flood tides and in the out-bay station.....	A-23
Figure 17. Effect of wind speed on water column clarity in the mid-bay.....	A-24
Figure 18. Variance component (standard deviations) and their confidence limits for the episodic nutrient survey samples.....	A-25
Figure 19. Daily cumulative precipitation and maximum wind speed in 2011.....	A-27
Figure 20. Seasonal variation of environmental variables in the bay (2011).....	A-28
Figure 21. Seasonal variation of nutrient concentrations in Weeks Bay mid-bay stations (2011).....	A-29
Figure 22. Seasonal fluctuation of stream nutrients from two freshwater inflows into Weeks Bay.....	A-30
Figure 23. Relationship between salinity and chl <i>a</i> concentrations in the mid-bay.....	A-31
Figure 24. Monthly average wind speed (meter/second) and monthly cumulative rainfall (mm) at the Weeks Bay weather station in 2008–2010 (NERRS/CDMO).....	A-33
Figure 25. Daily minimum DO fluctuations in four mid-bay stations in 2007–2011 (NERRS/CDMO).....	A-34
Figure 26. A time series decomposition of daily minimum DO concentrations at the center of the bay in 2007–2011.....	A-35

Figure 27. Daily minimum concentrations of DO at four mid-bay stations of Weeks Bay (data from NERRS/CDMO).....	A-36
Figure 28. Long-term daily mean salinity in four Weeks Bay stations (2007- 2011) (data from NERRS/CDMO).....	A-38
Figure 29. A time-series decomposition of daily mean salinity at the center of Weeks Bay (2007–2011).....	A-39
Figure 30. Long-term daily mean turbidity fluctuation at four stations (2007–2011).....	A-40
Figure 31. A time series decomposition of daily mean turbidity (log10 scale) at station WKBB-1 during year 2007–2011 (data from NERRS/CDMO).....	A-41
Figure 32. Long-term smoothing and seasonal variation of Chl <i>a</i> concentrations in four mid-bay stations decomposed from 10 years of observed data (data from NERRS/CDMO).....	A-42
Figure 33. Long-term smoothing and seasonal variation of NO <sub>2+3</sub> concentrations in four mid-bay stations decomposed from 10 years of observed data (data from NERRS/CDMO).....	A-43
Figure 34. Long-term smoothing and seasonal variation of NH <sub>4</sub> concentrations in four mid-bay stations decomposed from 10 years of observed data (data from NERRS/CDMO).....	A-44
Figure 35. Conductivity fluctuations at different depths at a Fish River location (FSHB-7, left) and the center of mid-bay (WKBB-1, right graph).....	A-45
Figure 36. DO trends at different depths by sampling locations.....	A-46
Figure 37. Spearman correlation coefficients among nutrient variables in the mid-bay data set. ....	A-48
Figure 38. The relationship between DO daily fluctuation and Chl <i>a</i> concentration in the water column. ....	A-49
Figure 39. Relationships between Chl <i>a</i> and TN and TP concentrations in Weeks Bay. ....	A-51
Figure 40. Random fitted lines derived from TN and TP (mg/L) multilevel models using MCMC procedure. ....	A-52
Figure 41. Regression Analyses between annual mean and summer (June–October) mean values of environmental variables and macroinvertebrate BIBI in the mid-bay stations. ....	A-55
Figure 42. The logistic regression model fits and their 90 percent confidence intervals between daily minimum DO and daily mean water temperature at the Fish River station (near WK-1, black lines) and other three stations in the Weeks Bay (NERRS/CDMO).....	A-57
Figure 43. The relationship between selected minimum DO values and discrimination of biological degradation. ....	A-58
Figure 44. The relative risk of daily minimum DO < 5 mg/L with increasing Chl <i>a</i> concentrations.....	A-59
Figure 45. Relationship between fluorometric and spectrophotometric methods based on monthly mean Chl <i>a</i> measurement at same locations.....	A-60



## 1 Introduction

Weeks Bay, Alabama, is a sub-estuary of Mobile Bay (Figure 1), and part of the National Estuarine Research Reserve System (NERRS). The Gulf of Mexico Alliance (GOMA) and Alabama Department of Environmental Management (ADEM) selected the bay as a location for developing pilot nutrient criteria. The project is part of GOMA's Action Plan II (Weeks Bay National Estuarine Research Reserve 2007, GOMA 2009) and is a pilot study intended to help establish a consistent method for the Gulf states to develop appropriate and protective nutrient criteria for estuaries. Results from this project are expected to contribute substantially to developing estuarine nutrient criteria for Alabama, a test of the monitoring and modeling framework of St. Louis Bay, Mississippi, and strengthen the overall approach for potential future application in other estuaries of the northern Gulf of Mexico.

Several studies have been conducted or are ongoing in the Weeks Bay watershed. The condition of habitats, land use, nutrients, and other aspects of the Weeks Bay system were evaluated by Miller-Way et al. (1996). O'Neil and Chandler (2003) described a long-term study (1994-1998) of water quality and biological monitoring focused on tidal and non-tidal streams of the watershed. The U.S. Environmental Protection Agency National Coastal Assessment (EPA/NCA) also sampled Mobile Bay and Weeks Bay (ADEM 2006) in the early 2000s and as recently as 2010. The National Oceanic and Atmospheric Administration's NERRS (<http://nerrs.noaa.gov/>) has maintained a long-term environmental monitoring program in Weeks Bay since 1995. The centralized data management office (CDMO) continues sampling and analysis of water quality and nutrient parameters at four Weeks Bay stations, and the U.S. Environmental Protection Agency Region 4 conducted a water quality study in 2011. These long-term data will provide additional support for nutrient criteria development for this study.

A monitoring plan was designed to collect data on a suite of variables related to water resources quality, specifically focused on determining the sources, fate, transport, and effects (SFTE) of nutrients in the Weeks Bay watershed (Tetra Tech 2011a). The purposes of the monitoring effort, implemented in 2011, and the associated analyses are as follows:

1. Summarize information to better understand the sources, fate, transport, and effects of nutrients in the Mobile Bay system
2. Estimate the status of nutrient concentrations
3. Develop a baywide estimate of biological conditions
4. Attempt to establish the relationship among nutrient concentrations, the resulting stressor characteristics, and biological conditions, thus contributing to developing appropriate nutrient criteria for protecting aquatic life in Weeks Bay

The primary purpose of any environmental monitoring program is to provide credible and defensible information that supports stated management objectives and decision making relative to the protection and enhancement of ecological health (NRC 1990, 2001). This analysis is targeted toward providing the information needed to understand the SFTE of nutrients in the Weeks Bay system. Results of the analyses are expected to describe the ecological health and related stressors originating as a result of excessive nutrient loadings in the system. Even though it is not guaranteed that the project will discover a linkage between nutrient loading and biological condition (Dauer et al. 2000; Nixon et al. 2001), marine and estuarine biological indicators are well documented as providing a rigorous and defensible statement of response to physical and chemical conditions (Engle et al. 1994; Weisberg et al. 1997; Engle and Summers 1999; Llansó et al. 2002; Thompson and Lowe 2004; Ranasinghe et al. 2009) and will directly contribute to integrated adaptive management that is necessary for ecosystem protection and restoration

(Boesch 2006). Those developing nutrient criteria should identify the level at which adverse biological response is detectable, the direct stressors (e.g., dissolved oxygen [DO] and chlorophyll *a* [Chl *a*]) causing biological degradation, and the corresponding levels of N and P that are responsible for the excessive algal productivity. This report summarizes the results from this monitoring work and other studies and offers recommendations toward pilot nutrient criteria.

## **2 Monitoring Design and Data Sets**

Historically, dominant land use/land cover in the Weeks Bay watershed has included row-crop agriculture and medium-density residential area. Significant urbanization has occurred across all subwatersheds in the past several decades (Morrison 2011). As a result, about 30 facilities with individual National Pollutant Discharge Elimination System (NPDES) permits are in the watershed, with a much larger number of facilities with general NPDES permits for stormwater discharges (Tetra Tech 2011a). Two of those are for wastewater treatment facilities; both are upstream of the Fish River in the Weeks Bay watershed. The remaining facilities with individual NPDES permits are primarily sand and gravel mining operations.

Thirteen stations throughout the Weeks Bay system were monitored for this project during 2011 (Figure 1), extending from the watersheds contributing the freshwater inflows, through Weeks Bay itself, and into Mobile Bay. In addition to the mid-bay sites (six stations), data and information from two major rivers Magnolia River (MR) and Fish River (FR) draining into the bay were collected to understand different hydrodynamic and nutrient flux processes that might ultimately be affecting bay conditions as reflected by Chl *a* concentrations. Two stations from Magnolia River (one wadeable stream and one tidal stream site) and four stations from Fish River (two tributary locations, and one wadeable and one tidal in the mainstem) were sampled to document the effects of freshwater inflows on nutrients and Chl *a* conditions. One station from Mobile Bay proper, outside Weeks Bay, was also sampled to detect the effects of the hydrologic exchanges between Weeks Bay and Bon Secour/Mobile Bay. Descriptions of the sampling locations are provided in Table 1.

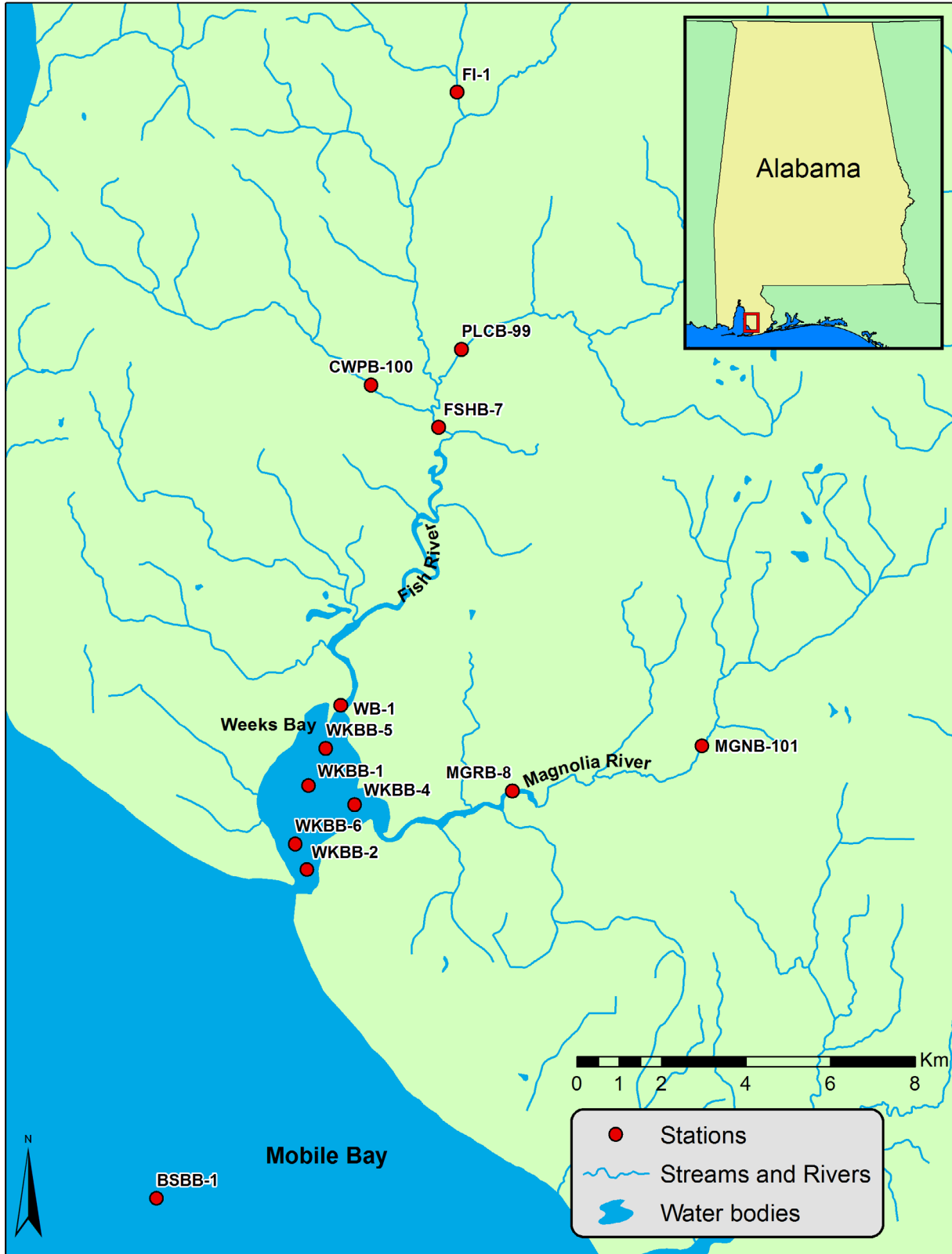

Figure 1. Sampling sites used for the Weeks Bay SFTE nutrient criteria pilot study.

**Table 1. Thirteen sampling locations for the Weeks Bay nutrient criteria pilot project (also see Figure 1).**

Station ID	Latitude	Longitude	Station type	Description
FI-1	30.5458	-87.7983	Wadeable stream	Fish River at ADEM trend station at AL Hwy 104 (USGS 2378500) – WKB_0010
FSHB-7	30.47421	-87.80221	Nonwadeable tidal river	Fish River at Baldwin Co. Road 32
WB-1	30.41469	-87.82583	Estuary	Fish River at ADEM trend station at mouth – main channel next to NERR marina – WKB_0003
WKBB-1	30.3975	-87.833611	Estuary	Weeks Bay near midpoint of the bay (Middle Bay) – WKB_0004
WKBB-5	30.405525	-87.829414	Estuary	Weeks Bay 550 meters due south of NERR peninsula – WKB_0005
WKBB-2	30.376597	-87.835437	Estuary	Weeks Bay near outlet to Bon Secour Bay 160 meters due east of boat ramp at Fish River Point
BSBB-1	30.367913	-87.847265	Estuary	Bon Secour Bay 1370 meters southwest of boat ramp at Fish River Point at Weeks Bay outlet
WKBB-4	30.393598	-87.822241	Estuary	Weeks Bay at mouth of Magnolia River 366 meters due south of point
WKBB-6	30.385096	-87.836814	Estuary	Weeks Bay approximately 0.8 km north of boat ramp at mouth of bay – WKB_0007
MGRB-8	30.396694	-87.783444	Nonwadeable tidal river	Magnolia River approximately 4 km upstream of Weeks Bay and upstream of Weeks Creek
MGNB-101	30.4066214	-87.736712	Wadeable stream	Magnolia River at ADEM trend station at US Hwy 98 (USGS station 2378300) – WKB_0009
CWPB-100	30.483118	-87.818941	Wadeable stream	Cowpen Branch at Baldwin Co. Road 33
PLCB-99	30.49090831	-87.7967277	Wadeable stream	Polecat Creek at Baldwin Co. Road 9

Nutrient and other water quality parameters were collected differently for this project, including monthly, quarterly, and continuous in some periods. Monthly sampling was conducted from February to November for several water quality parameters (e.g., DO, salinity, conductivity, chloride) from various depths during each sampling event. Only one grab sample was collected in each sampling event for each location. Chl *a* was measured in a composite sample collected from the photic zone. In addition to monthly sampling, four intensive episodic nutrient surveys were conducted for the five mid-bay stations on April 17–20, June 13–17, July 5–8, and September 19–23. During these events, continuous sonde monitoring of water quality parameters was conducted, and three replicate samples of nutrient parameters were analyzed. The details about the parameter analysis are in the ADEM Quality Assurance Project Plan (QAPP) (ADEM 2011).

ADEM selected Chl *a* as the primary indicator of biological response to nutrient enrichment in the bay overall, with benthic invertebrates as the secondary biological indicator. Note that Chl *a* concentration was measured using the spectrophotometric method for this study, which is different from other studies (e.g., WKB NERR Nutrient Metadata 2008, the NERRS long-term monitoring <http://cdmo.baruch.sc.edu/get/export.cfm>) conducted in the same region, which used the fluorometric method.

### 3 Basic Water Quality Characteristics

Several nutrient-related environmental variables were monitored from January to November. Because the sampling locations include several types of water bodies, the ranges of nutrient and other water quality parameters vary widely (Table 2), most noticeably, that for salinity, which ranges from 0 to 23.4 parts per thousand (ppt), representing the shift from freshwater to marine. These sampling stations should be further stratified to reflect the conditions for different types of water bodies.

**Table 2. Summary statistics of environmental variables measured in the 13 sampling stations**

Analyte (units)	No. of samples	Mean	Median	Standard deviation	Minimum	Maximum
CBOD5 (mg/L)	172	3.1	3.1	1.83	1	7.9
TOC (mg/L)	169	3	3.2	1.44	0.44	6.61
DOC (mg/L)	166	2.6	2.755	1.01	0.56	5.54
TDS (mg/L)	172	5,509.1	5,280	4,687.49	32	17,000
TSS (mg/L)	172	19.4	16	18.32	5	133
Alkalinity (mg/L)	172	40	45	26.48	4	94
NH <sub>3</sub> -N (mg/L)	172	0.04	0.014	0.09	0.014	0.77
NO <sub>2+3</sub> -N(mg/L)	172	0.55	0.0335	0.75	0.0025	2.66
TKN (mg/L)	172	0.94	0.885	0.8	0.035	5.4
Total P (mg/L)	172	0.07	0.064	0.05	0.002	0.45
DRP (mg/L)	172	0.01	0.008	0.03	0.003	0.2
Chl a (µg/L)	172	6.74	3.35	12.72	0.5	107
Turbidity (NTU)	282	11.6	7	13.14	1	87
Cl (mg/L)	172	3,644.6	3,150	3,357.79	0.153	13,000
DO saturation (%)	417	88.1	86.9	30.51	1.1	171.9
DO (mg/L)	1,142	7.1	7.39	2.38	0.09	14.55
pH (SU)	1,142	7.4	7.8	0.99	5.01	9.44
Cond (µS/cm)	1,142	10,711.5	9,633.3	9,335.63	42.8	36,838.1
Salinity (ppt)	1,104	6.5	6.015	5.67	0.01	23.37

Note: mg/L = milligrams per liter; µg/L = micrograms per liter; NTU = nephelometric turbidity units; SU = standard units; ppt = parts per thousand

### 4 Site Classification

Temperature, pH, Chloride, salinity, conductivity, and DO for each of the 13 sampling stations were monitored extensively at various depths, and their median values and ranges calculated (Table 3). Salinity at individual stations varied from 0.01–23.4 ppt (Figure 1), which corresponds to a conductivity range of 42.8–36,838 µS/cm. A steady increase in salinity is observed with the decreasing distance from (nearer to) the out-bay station (Figure 2). On the basis of median salinity measured at each station, we propose classifying the stations into four categories (Figure 2):

1. Freshwater streams (less than 1 ppt)
2. Tidal streams (1–5 ppt)
3. Mid-bay locations (5–12 ppt)
4. Out-bay station (Mobile Bay greater than 12 ppt)

The freshwater streams are potentially blackwater streams (though, no color measures were taken), with pH generally less than 7 (Table 3). Salinity values in these streams were near 0 with conductivity below 100  $\mu\text{S}/\text{cm}$ . DO concentrations were consistently high in the freshwater areas, ranging from 6.3 to 9.6 mg/L. Tidal streams were affected by both the marine tidal and freshwater flow (thus having a wide range of salinity) in this data set measuring between 0–19.3 ppt. These stations also had a wide range of DO (0.3 to 14.6 mg/L) but pH values were usually greater than 7. Stations in Weeks Bay and Mobile Bay are mostly marine, though, low salinity (less than 5 ppt) was also observed occasionally. The criterion for DO in Alabama coastal waters is 5.0 mg/L at a depth of 5 feet (approximately 1.5 meters) (ADEM 2010a, 2011). Occasional exceedence of the DO criterion was observed in the mid-bay stations. Detailed analysis of DO fluctuation at these stations follows below.

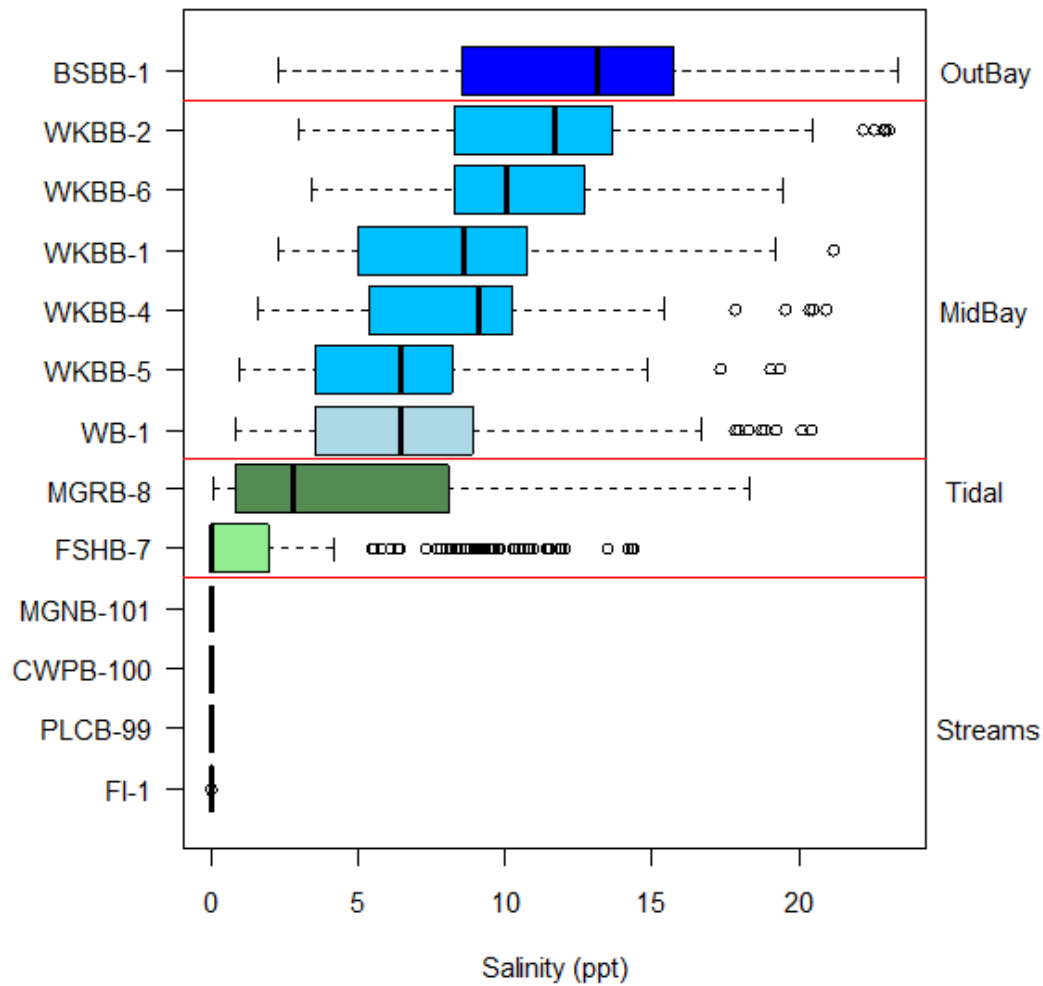

Note: Box colors: Fish River sites = light green; Magnolia River sites = dark green; mid-bay sites = light and modest blue; Mobile Bay sites = dark blue. Sampling stations are ordered top to bottom by increasing distance from the Mobile Bay station (BSBB-1). Each box represents the lower and upper quartiles and median values at each station; the whiskers extend to the most extreme data point which is  $\leq 1.5x$  the interquartile range from the box. The dots are the outliers which are  $> 1.5x$  the interquartile range.

Figure 2. Surface salinity for 13 stations in the Weeks Bay watershed.

**Table 3. Median values (and ranges) of environmental variables measured at 13 sampling locations**

Station_ID	Temperature (°C)	Cl (mg/L)	DO (mg/L)	pH (SU)	Cond (µS/cm)	Salinity (ppt)	SaIClass
CWPB-100	21.8 (16.6–23.7)	6.2 (0.2–6.4)	7.5 (7.2–8.8)	5.6 (5–6.1)	44 (43–47)	0.01 (0.01–0.01)	Streams
PLCB-99	22.8 (16.1–24.8)	9 (0.2–10)	7.3 (6.3–8.8)	6.3 (5.9–7)	62 (59–68)	0.02 (0.02–0.02)	Streams
FI-1	21.9 (14.1–24.1)	7.5 (0.2–7.9)	8.1 (7.7–9.6)	6 (5.4–7.4)	61 (48–66)	0.02 (0.01–0.02)	Streams
FSHB-7	24 (15–29.1)	11.5 (8.6–4,600)	6.2 (0.1–12)	6.2 (5.4–7.9)	68 (59–23,627)	0.03 (0.02~14.35)	Tidal
MGNB-101	22 (16.5–23.8)	11 (0.2–11)	7.5 (6.9–8.7)	5.9 (5.3–7.4)	71 (68–73)	0.02 (0.02–0.02)	Streams
MGRB-8	28 (16.5–31.5)	1,900 (60–9,200)	7.3 (0.3–14.6)	7.1 (6–8.4)	5,196 (141–29,665)	2.8 (0.1–18.3)	Tidal
WB-1	28.1 (13.5–32.8)	3,600 (490–11,000)	7 (2.1–13.5)	8 (6.5–8.9)	11,417 (1,699–32,543)	6.5 (0.9–20.4)	Mid-bay
WKBB-1	27.8 (19.1–32.9)	5,150 (1,400–9,400)	7.9 (4.6–10.5)	8.3 (7.7–8.9)	14,771 (4,257–33,695)	8.6 (2.3–21.2)	Mid-bay
WKBB-2	27.5 (17.4–32.3)	6,400 (2,000–13,000)	7.4 (3.6–11)	8.1 (7.7–9.2)	19,728 (5,533–36,373)	11.7 (3–23)	Mid-bay
WKBB-4	28.6 (18.8–33.5)	5,400 (930–11,000)	8.4 (4.4–13.8)	8.4 (7.7–9.4)	15,608 (3,077–33,276)	9.1 (1.6–20.9)	Mid-bay
WKBB-5	28.5 (18.9–32.9)	3,750 (540–9,400)	8.5 (5.9–11.7)	8.5 (7.4–8.9)	11,225 (1,888–31,144)	6.4 (1–19.4)	Mid-bay
WKBB-6	27.6 (18.6–32.7)	6,050 (2,000–10,000)	8.2 (3.9–14.5)	8.3 (7.8–9.4)	17,230 (6,244–31,307)	10.1 (3.4–19.5)	Mid-bay
BSBB-1	27.4 (17.1–32.4)	8,200 (1,900–13,000)	7.2 (3.7–12.2)	8 (7.6–9.4)	22,074 (4,262–36,838)	13.2 (2.3–23.4)	Out-bay

## 5 Spatial Variations of Nutrient Concentrations in the Weeks Bay System

### 5.1 Total Organic Carbon Concentrations (TOC)

In general, TOC (along with dissolved organic carbon [not shown]) are lowest in the freshwater streams, increase in the tidal streams, and reach the highest level in the mid-bay stations and the out-bay station (Figure 3). One stream in the Fish River watershed (CWPB-100) and one stream in the upper Magnolia River have lower TOC concentrations than the rest of the streams.

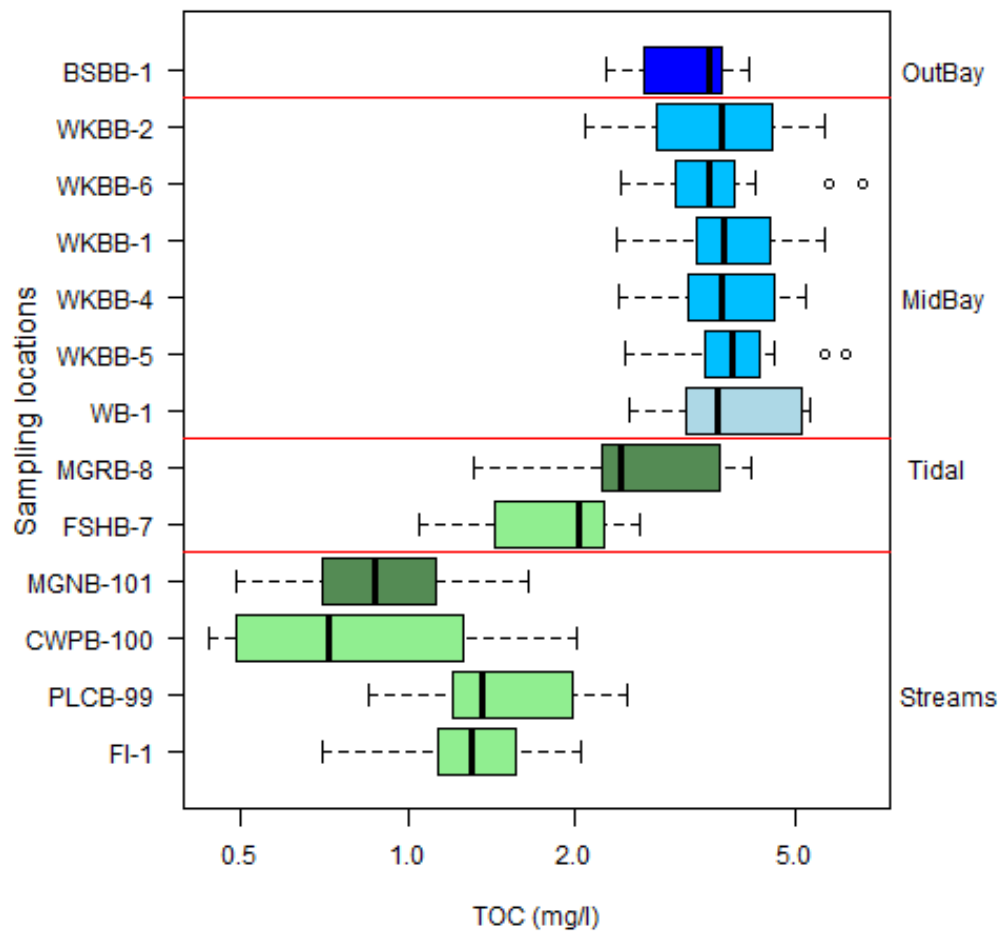

Note: Box colors: Fish River sites = light green; Magnolia River sites = dark green; mid-bay sites = light and modest blue; Mobile Bay sites = dark blue. Sampling stations are ordered top to bottom by increasing distance from the Mobile Bay station (BSBB-1). Each box represents the lower and upper quartiles and median values at each station; the whiskers extend to the most extreme data point which is  $\leq 1.5x$  the interquartile range from the box. The dots are the outliers which are  $> 1.5x$  the interquartile range.

Figure 3 TOC for 13 stations over the entire Weeks Bay system.



## Total Nitrogen (TN)

TN concentrations (Figure 4) are highest in the most upstream stations of Fish River mainstem (FI-1) and the Magnolia River (MGNB-101). TN concentrations in tidal streams are much diluted (FSHB-7 and MGRB-8) while mixing with increasingly low nitrogen marine water and other low nitrogen streams (CWPB-100 and PLCB-99). The median nitrogen concentrations at the mouths of the rivers (WB-1 and MGRB-8) are lower than those of the streams but higher than other mid-bay stations.

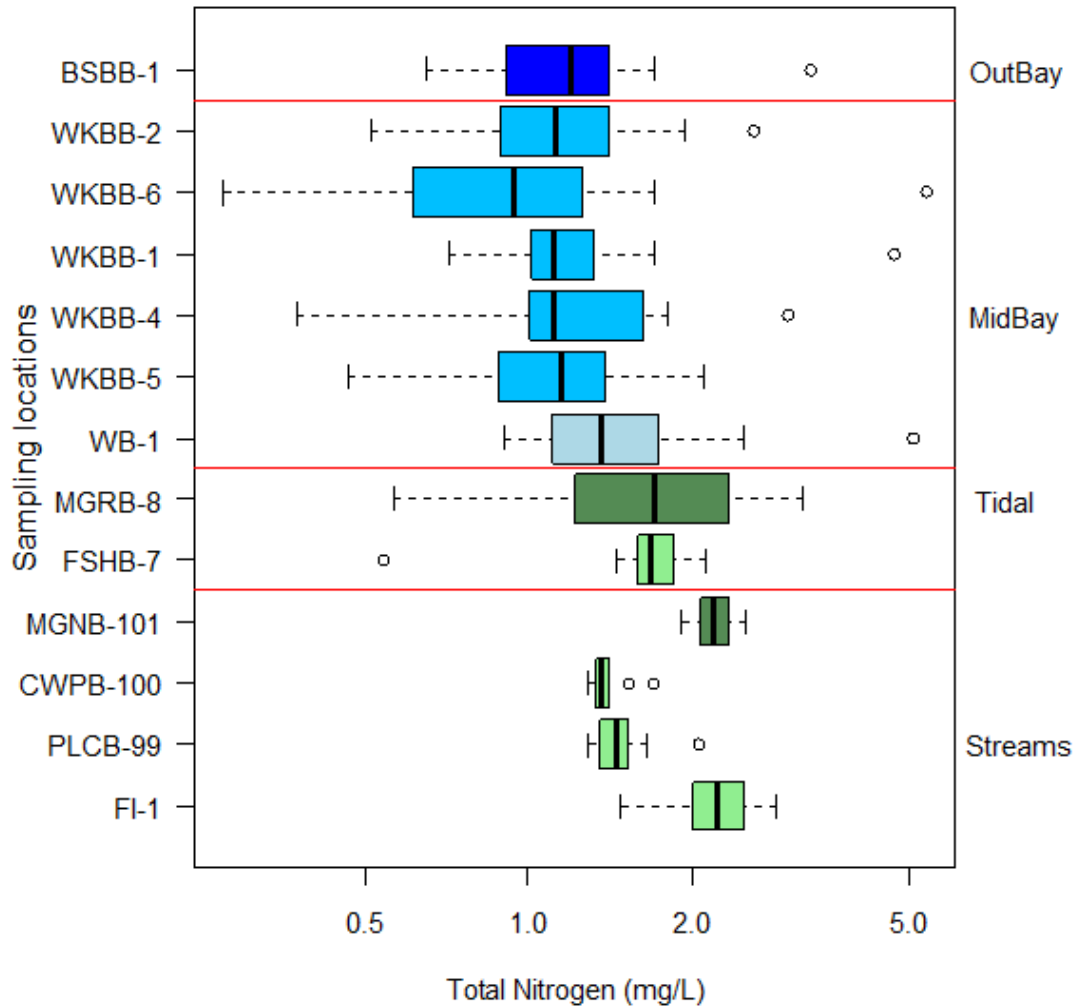

Note: Box colors: Fish River sites = light green; Magnolia River sites = dark green; mid-bay sites = light and modest blue; Mobile Bay sites = dark blue. Sampling stations are ordered top to bottom by increasing distance from the Mobile Bay station (BSBB-1). Each box represents the lower and upper quartiles and median values at each station; the whiskers extend to the most extreme data point which is  $\leq 1.5x$  the interquartile range from the box. The dots are the outliers which are  $>1.5x$  the interquartile range.

**Figure 4. TN concentrations for 13 stations over the Weeks Bay system.**

## 5.2 Nitrate-Nitrite (NO<sub>2+3</sub>-N)

NO<sub>2+3</sub>-N concentrations in the streams are substantially higher than those in the mid-bay (Figure 5). The highest concentrations of nutrients flow from the upper streams of the two main stems, then are significantly reduced because of dilution with marine water at the mouth of rivers, but are still much higher than in the mid-bay. NO<sub>2+3</sub>-N concentrations are often below detection in the bay, especially in Mobile Bay proper (BSBB-1).

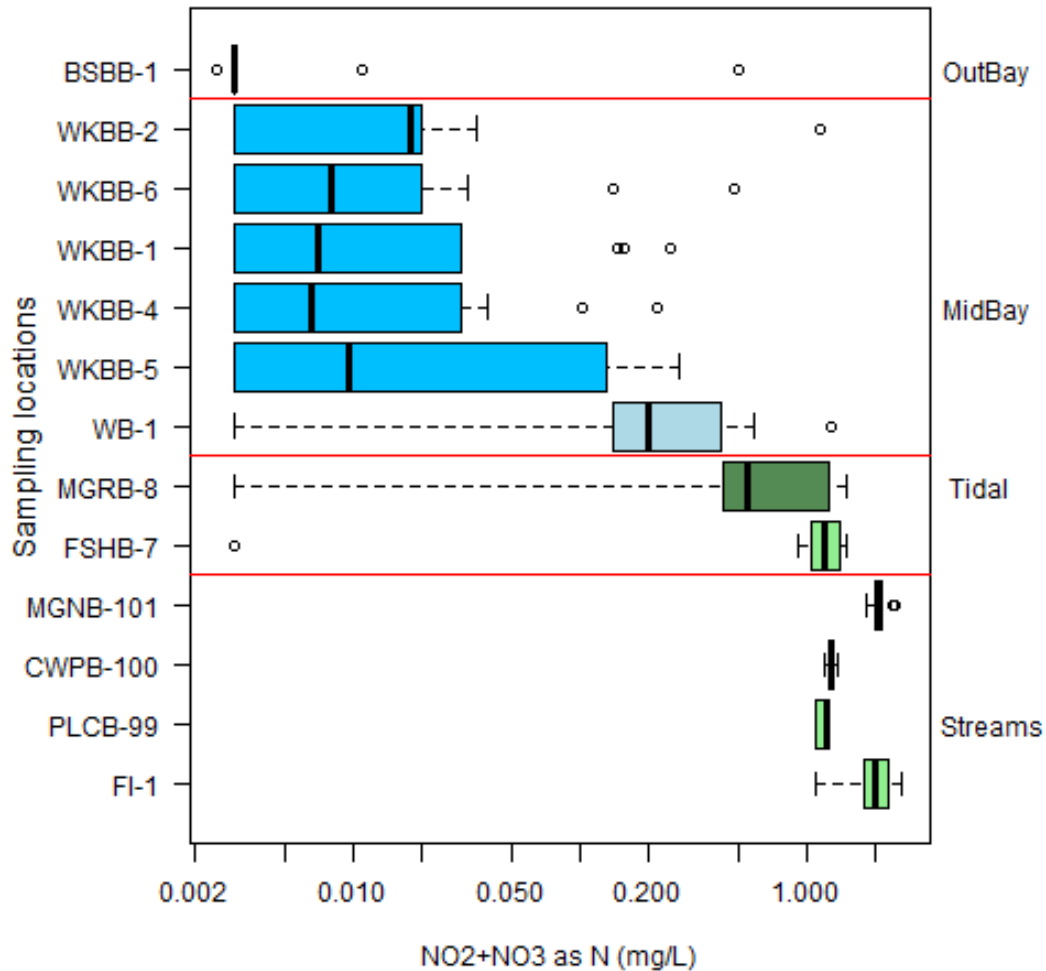

Note: Box colors: Fish River sites = light green; Magnolia River sites = dark green; mid-bay sites = light and modest blue; Mobile Bay sites = dark blue. Sampling stations are ordered top to bottom by increasing distance from the Mobile Bay station (BSBB-1). Each box represents the lower and upper quartiles and median values at each station; the whiskers extend to the most extreme data point which is  $\leq 1.5x$  the interquartile range from the box. The dots are the outliers which are  $>1.5x$  the interquartile range.

Figure 5. NO<sub>2+3</sub>-N concentrations for 13 stations over the Weeks Bay system.

### 5.3 Total Phosphorus (TP)

Similar to nitrate, TP concentrations are highest in the most upstream Fish River mainstem site (FI-1) but not in the Magnolia River station. TP concentrations are diluted in the lower Fisher River by mixing with two low nutrient tributaries (CWPB-100 and PLCB-99) and resulting in similar levels to the mid-bay. The median TP concentrations at the mouth of the Magnolia River (MGRB-8) are lower than the mid-bay stations (Figure 6).

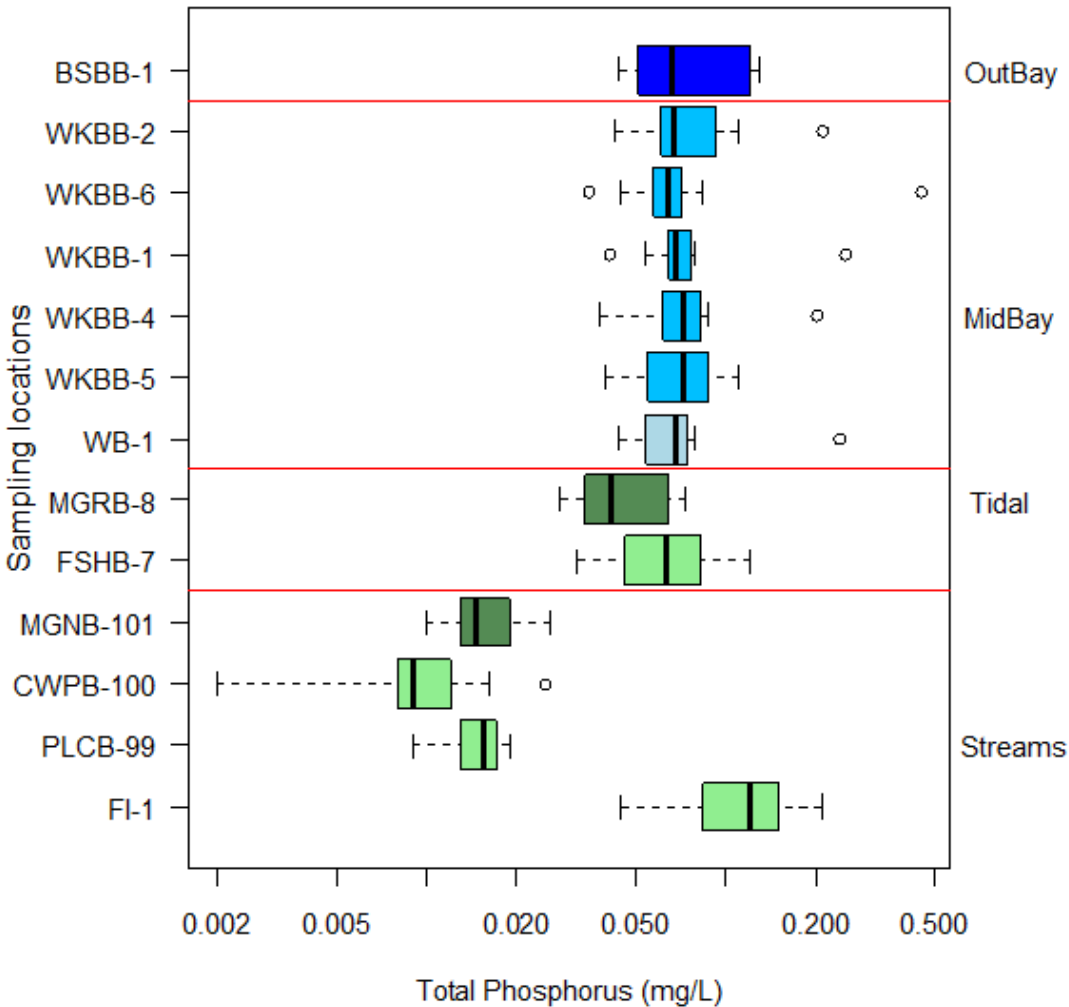

Note: Box colors: Fish River sites = light green; Magnolia River sites = dark green; mid-bay sites = light and modest blue; Mobile Bay sites = dark blue. Sampling stations are ordered top to bottom by increasing distance from the Mobile Bay station (BSBB-1). Each box represents the lower and upper quartiles and median values at each station; the whiskers extend to the most extreme data point which is  $\leq 1.5x$  the interquartile range from the box. The dots are the outliers which are  $>1.5x$  the interquartile range.

**Figure 6. TP concentrations for 13 stations over the entire Weeks Bay system.**

## 5.4 Chlorophyll a (Chl a)

Not surprisingly, Chl *a* concentrations in streams are very low in comparison to mid-bay stations (Figure 7); phytoplankton production in streams is always lower than that in open water systems (lakes and ponds). Most of the Chl *a* measurements are below detection in the freshwater streams, but they steadily increase in downgradient non-wadeable streams (FSHB-7 and MGRB-8).

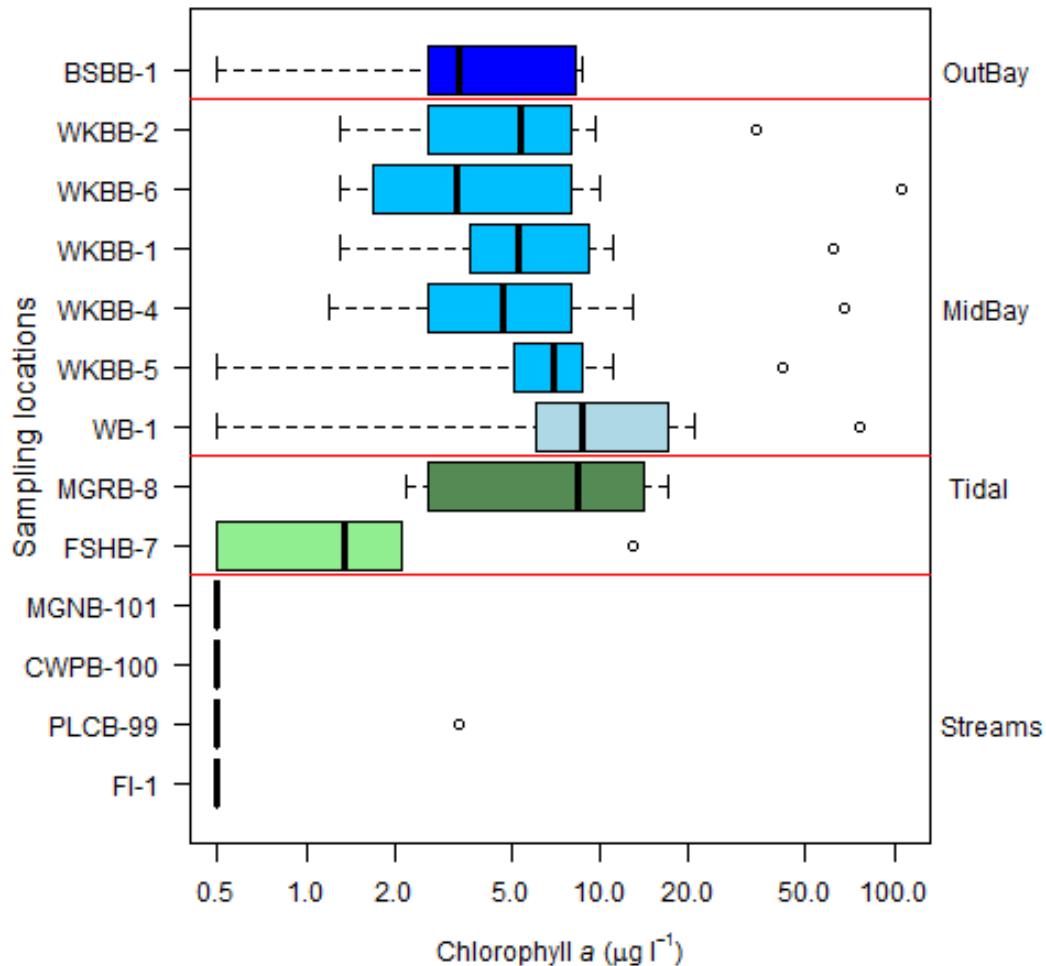

Note: Box colors: Fish River sites = light green; Magnolia River sites = dark green; mid-bay sites = light and modest blue; Mobile Bay sites = dark blue. Sampling stations are ordered top to bottom by increasing distance from the Mobile Bay station (BSBB-1). Each box represents the lower and upper quartiles and median values at each station; the whiskers extend to the most extreme data point which is  $\leq 1.5x$  the interquartile range from the box. The dots are the outliers which are  $> 1.5x$  the interquartile range.

Figure 7. Chl *a* concentrations for 13 stations over the entire Weeks Bay system.

## 5.5 Turbidity

Throughout the watershed, turbidity is lowest in streams (Figure 8). A significant increase in turbidity is observed in non-wadeable tidal streams, then peaks in the mid-bay stations. It could be due to increasing production in sestonic Chl *a* and increases of total suspended solids (TSS). Changes in wind speed, direction, precipitation, and surface and stream runoff might also lead to bottom mixing in the bay.

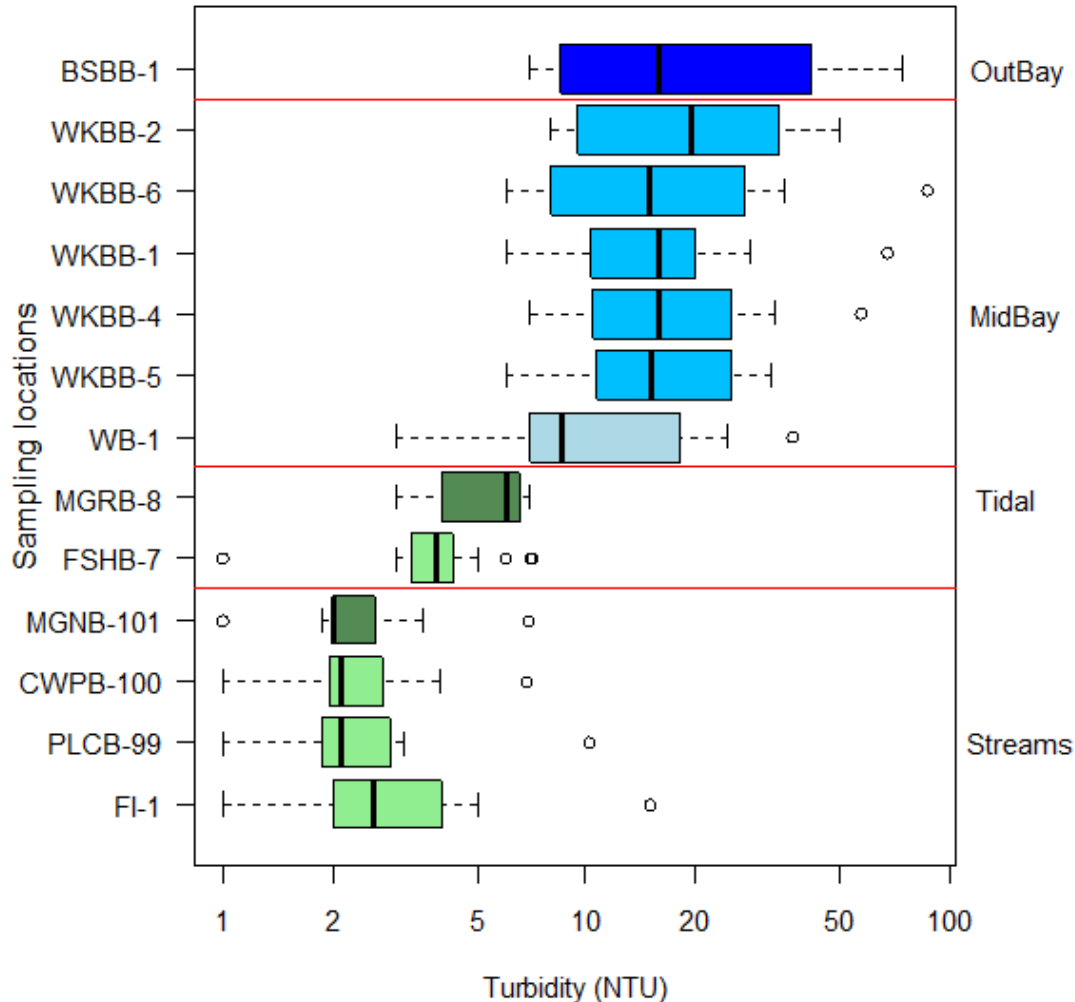

Note: Box colors: Fish River sites = light green; Magnolia River sites = dark green; mid-bay sites = light and modest blue; Mobile Bay sites = dark blue. Sampling stations are ordered top to bottom by increasing distance from the Mobile Bay station (BSBB-1). Each box represents the lower and upper quartiles and median values at each station; the whiskers extend to the most extreme data point which is  $\leq 1.5x$  the interquartile range from the box. The dots are the outliers which are  $>1.5x$  the interquartile range.

**Figure 8. Turbidity for 13 stations over the entire Weeks Bay system.**

Increasing turbidity downstream leads to declines in Secchi depth readings (Figure 9). No measurements were taken in wadeable streams. Secchi depth is highest in non-wadeable streams but declines to the lowest in the bay. Surprisingly, the Fish River downstream areas (FSHB-7-> WB-1->WKBB-5 -> WKBB-1) has better water clarity than the Magnolia River downstream (MGRB-8->WKBB-4), probably because locations in the former are deeper than those of the Magnolia River. Also, the Magnolia River tends to be more colored.

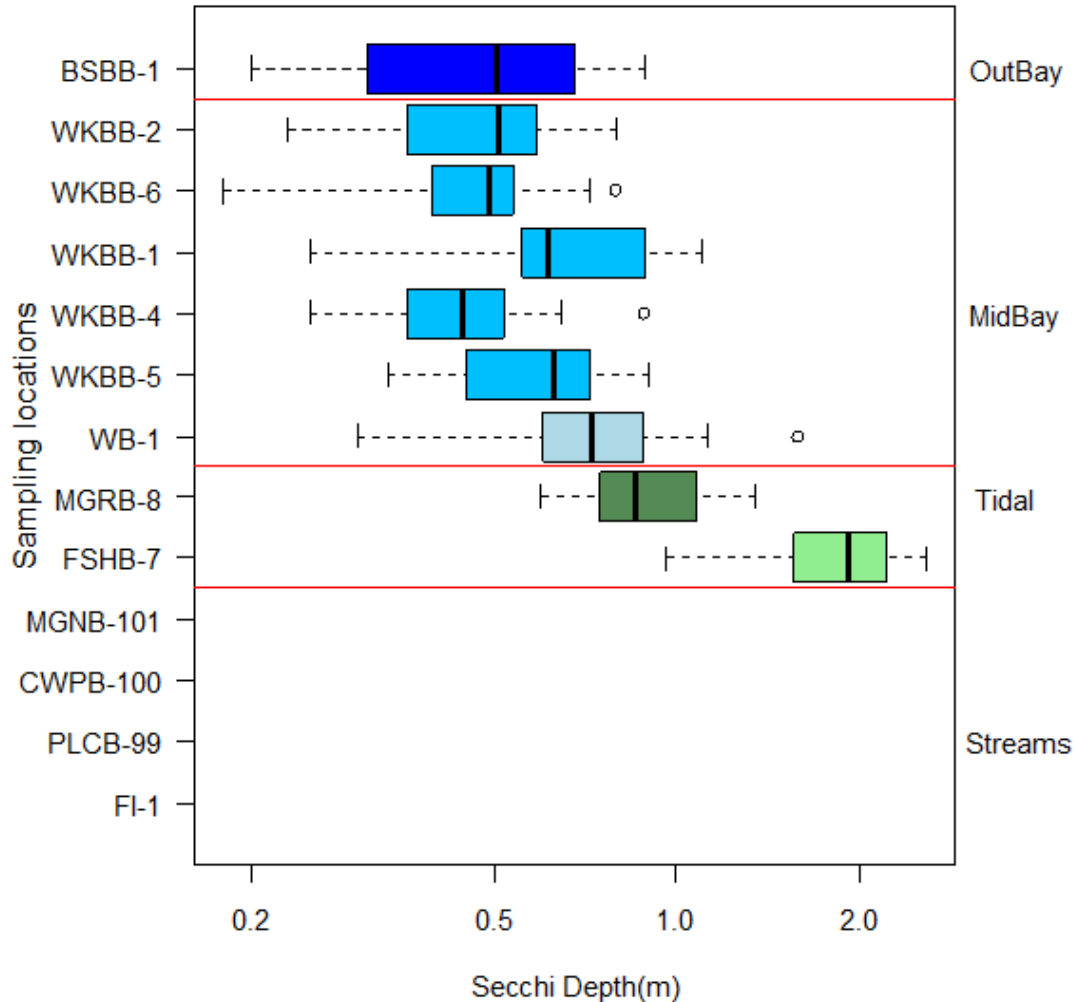

Note: Box colors: Fish River sites = light green; Magnolia River sites = dark green; mid-bay sites = light and modest blue; Mobile Bay sites = dark blue. Sampling stations are ordered top to bottom by increasing distance from the Mobile Bay station (BSBB-1). Each box represents the lower and upper quartiles and median values at each station; the whiskers extend to the most extreme data point which is  $\leq 1.5x$  the interquartile range from the box. The dots are the outliers which are  $>1.5x$  the interquartile range.

**Figure 9. Secchi Depth in nine stations over the entire Weeks Bay system.**

## 5.6 Total Suspended Solids (TSS)

Median TSS is lowest in wadeable streams and higher as measurements are taken nearer to Weeks Bay (Figure 10). TSS in the tidal streams increases because of mixing between freshwater and marine waters, especially in the lower Magnolia River and at the mouth of the Fish River, and then are higher in the mid-bay. TSS is highest in Mobile Bay itself.

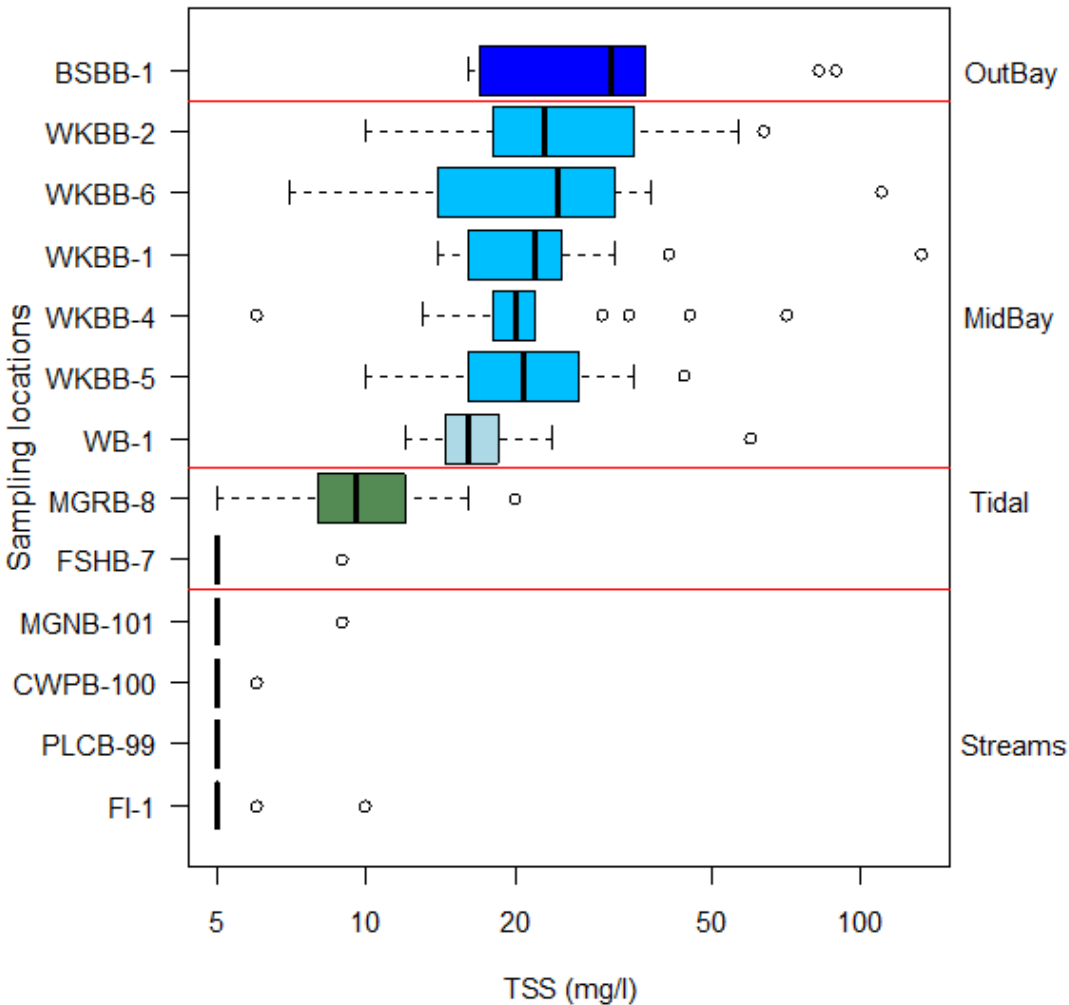

Note: Box colors: Fish River sites = light green; Magnolia River sites = dark green; mid-bay sites = light and modest blue; Mobile Bay sites = dark blue. Sampling stations are ordered top to bottom by increasing distance from the Mobile Bay station (BSBB-1). Each box represents the lower and upper quartiles and median values at each station; the whiskers extend to the most extreme data point which is  $\leq 1.5x$  the interquartile range from the box. The dots are the outliers which are  $> 1.5x$  the interquartile range.

Figure 10. TSS in 13 stations over the Weeks Bay system.

O'Neil and Chandler (2003) studied water quality characteristics of the Weeks Bay watershed from 1994 to 1998. Although their study focused on freshwater streams in the upper watershed, it includes several stations the same as, or near, stations in this study (WB-1, PLCB-99, CWPB-100, MGNB-101 and MGRB-8). Several nutrient parameters, e.g., TN, NO<sub>2+3</sub>, NH<sub>3</sub>, have similar ranges in these stations, but TP concentrations are significantly higher at station WB-1 (median more than 1 mg/L) in this study than historical TP range (0.01 – 0.1 mg/L). Upstream wastewater treatment plant and rapid urbanization in Fish River watershed might have contributed to the rising TP concentrations. Another significant finding is that sediment-related parameters, e.g., TSS and turbidity, have decreased over the past 15 years or so in all stations, indicating reduced sediment loadings from upstream watersheds.

## 6 Spatial and Temporal Variation in the Bay

Environmental variables fluctuate both spatially and temporally in the Weeks Bay where freshwater and marine water converge. Spatially, many nutrient variables, such as DO and Chl *a* can vary dramatically from station to station, and even from different depths at the same locations. Temporally, DO and Chl *a* concentrations can vary daily, seasonally/monthly, and annually. Therefore, a better understanding of the variability of these variables would help establish ecologically meaningful nutrient endpoints. This study used two types of monitoring to evaluate short-term (daily) and intermediate-term (monthly and seasonally) variability in Weeks Bay. The four intensive episodic nutrient surveys at the five mid-bay stations characterized water column nutrient concentrations in several consecutive days of sampling, bracketing the neap and spring tides. The monthly sampling collected nutrient and other water quality parameters from surface water once every month from February to November. DO and several other parameters were also measured at different depths for the same locations. Long-term continuous monitoring data spanning 2002–2011 (NERRS/CDMO; <http://cdmo.baruch.sc.edu/>) were also analyzed to evaluate patterns of changes in different years and to consolidate our knowledge of spatial and temporal patterns observed in the 2011 sampling season.

### 6.1 Short-Term Variation

Four episodic surveys including both spring tides and neap tides were conducted in four separate sampling efforts. Spring tides present the maximum tide range between low- and high-tide elevations, and occur on full and new moons, while neap tides represent the minimum tidal elevation change and correspond to quarter moon phases (<http://en.wikipedia.org/wiki/Tide>). Tide changes in Weeks Bay generally occur in a single cycle and represent a relatively small change in stage elevation relative to some other coastal areas; therefore, the representation of mid tides is not critical for documenting tidal characteristics (Tetra Tech 2011a). Nutrient parameters during two spring tide (April and June) and two neap tide events (July and September) were sampled. During the episodic events, continuous sonde monitoring was also conducted to characterize the fluctuations of water quality parameters (including DO) over several days.

### Continuous Monitoring of Water Quality Parameters

Continuous sonde monitoring was conducted during the four episodic survey periods. Water temperature, pH, conductivity, and DO were monitored continuously during these periods at two wadeable stream sites, two tidal stream sites, and three mid-bay stations. Water temperatures were lowest in freshwater streams consistently over the monitoring periods, about 4–7 degrees (°C) below mid-bay locations depending on the months (Figure 11). Spatially, temperatures increase in downstream areas of watersheds. Only the April sampling event shows a constant increase of temperature over the 5-day period, but all the events for all stations revealed diel fluctuations in temperature.



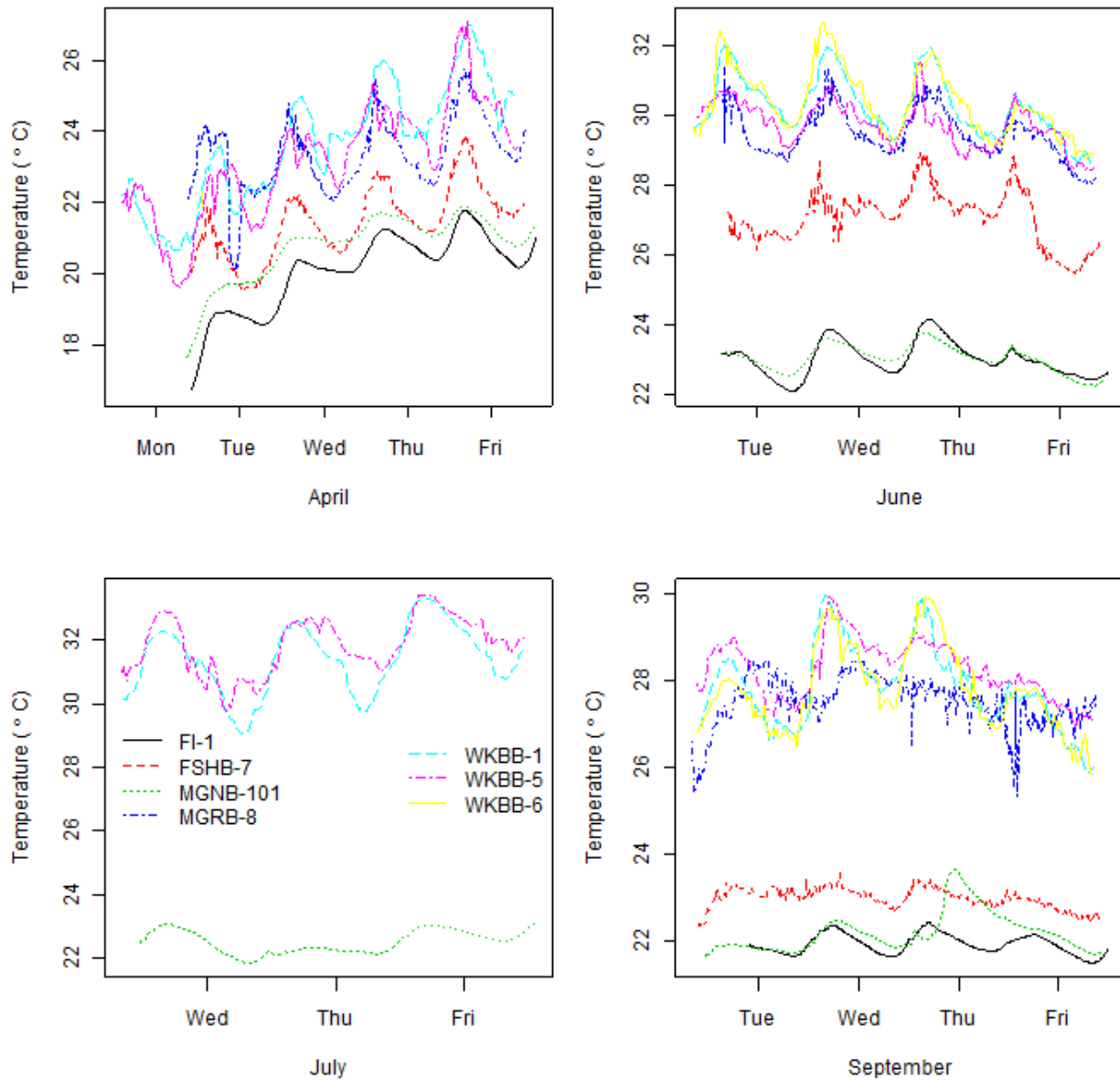

Note: Site locations: freshwater, FI-1 and MGNB-101; tidal streams, MGRB-8 and FSHB-7; mid-bay, WKBB.

**Figure 11. Continuous monitoring data showing water temperature fluctuation during four sampling events on April 17–20, June 13–17, July 5–8, and September 19–23.**

The pH values are lowest (less than 6 SU) in freshwater streams consistently over the monitoring periods and show little diurnal fluctuation (Figure 12). Tidal streams rise in pH (Figure 12) and begin showing diurnal fluctuation, whereas mid-bay stations have much higher pH and strong diurnal or tidal fluctuation. Daily pH fluctuation in the mid-bay could span 7 to 9 in April, but is less variable in other months.

Conductivity values reflect changes in salinity during the spring and neap tides over the four sampling events (Figure 13). In general, wadeable streams are not affected by tides. The two tidal streams are mostly affected in September in the neap tide. Mid-bay stations show larger fluctuations of conductivity during spring tides than in neap tides.

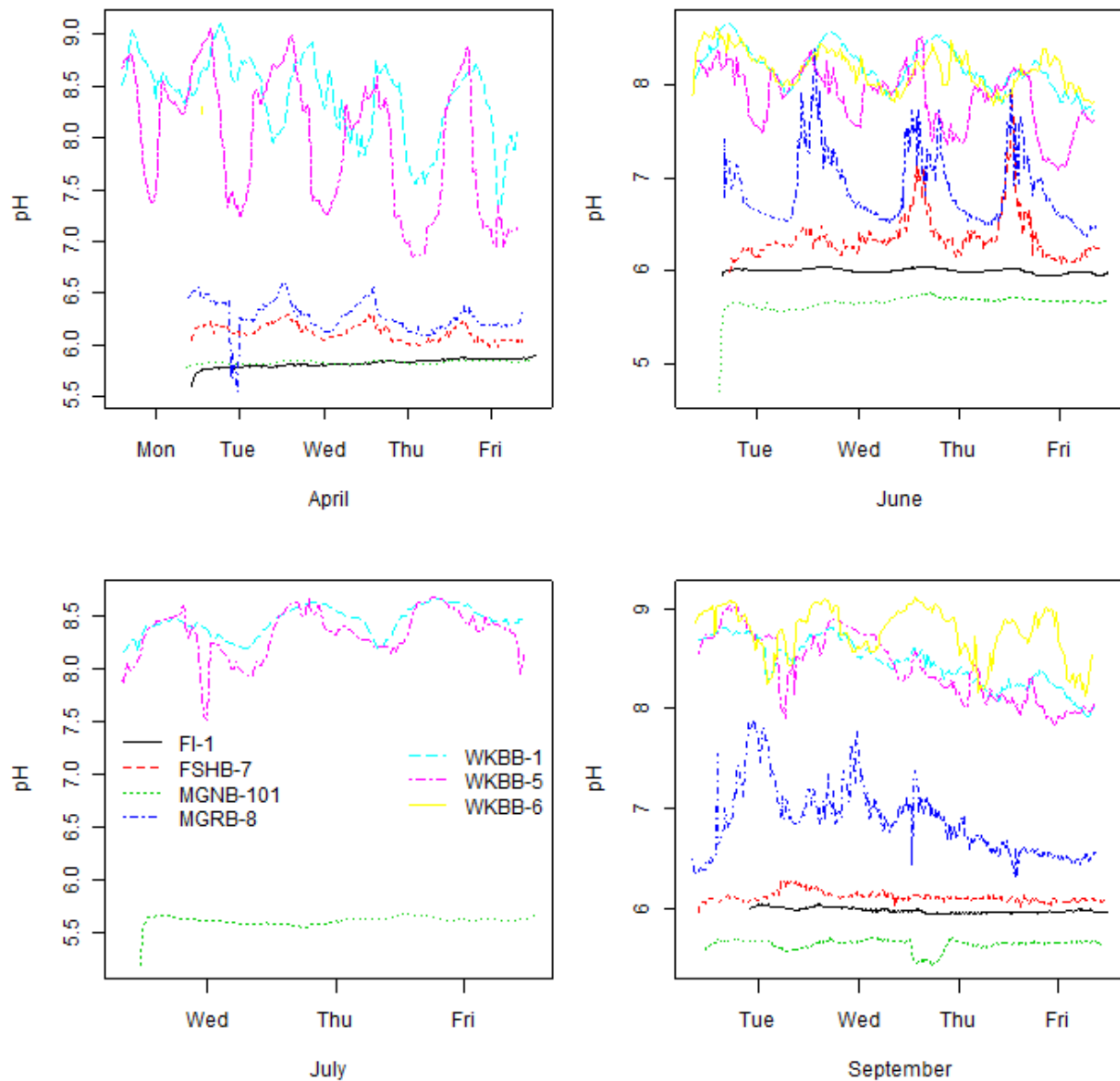

Note: Site locations: freshwater, FI-1 and MGNB-101; tidal streams, MGRB-8 and FSHB-7; mid-bay, WKBB.

**Figure 12. Continuous monitoring data showing pH fluctuation during four sampling events on April 17–20, June 13–17, July 5–8, and September 19–23.**

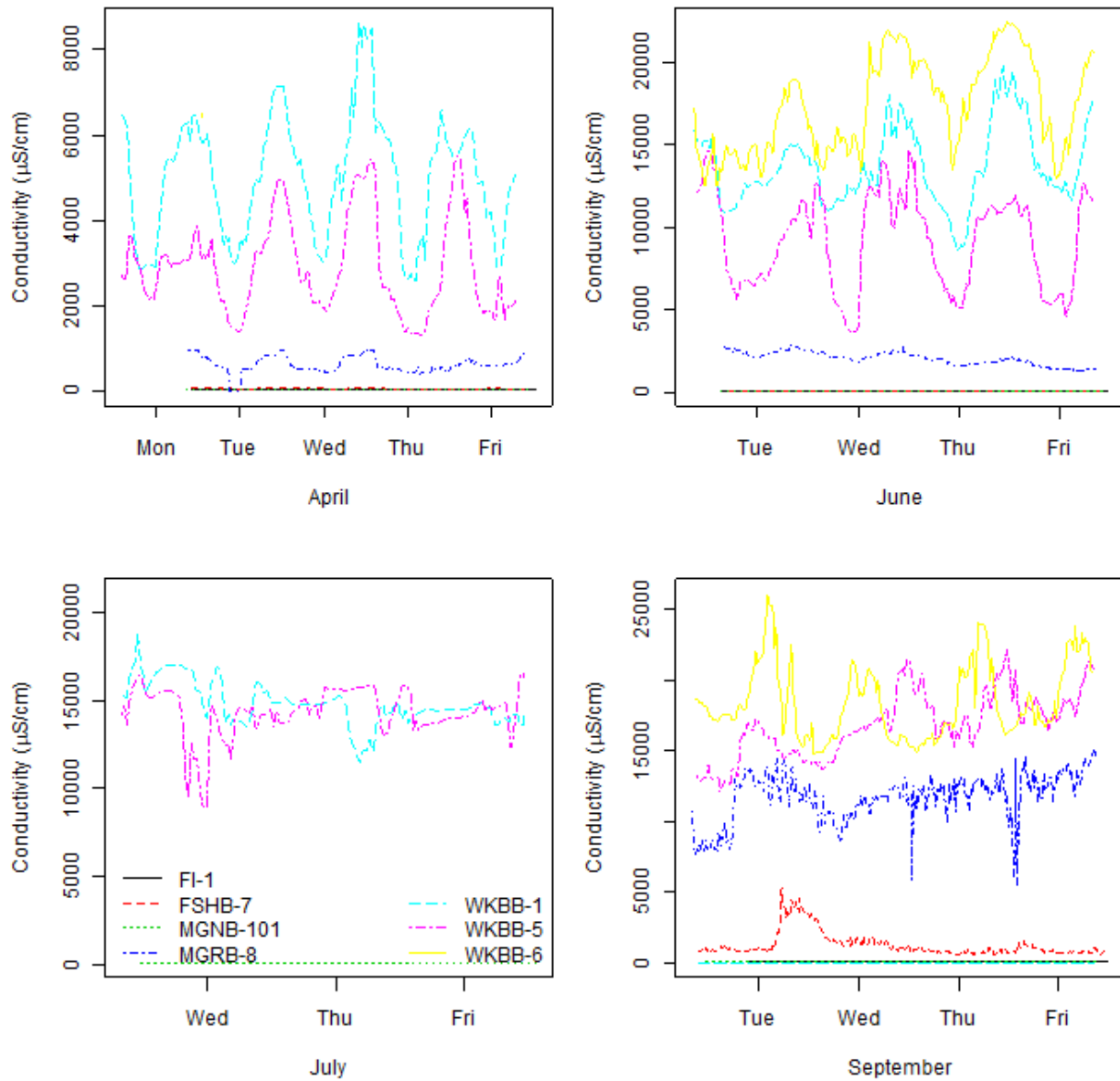

Note: Site locations: freshwater, FI-1 and MGNB-101; tidal streams, MGRB-8 and FSHB-7; mid-bay, WKBB.

**Figure 13. Continuous monitoring data showing conductivity fluctuation during four sampling events on April 17–20, June 13–17, July 5–8, and September 19–23.**

DO from these four continuous monitoring events show wide daily fluctuation in the mid-bay locations and tidal streams (Figure 14). Low DO conditions (less than 5 mg/L) did not occur in the spring (April), occasionally in the summer in the mid-bay during these events, although several readings of DO are much lower in June. One of the tidal streams (MGRB-8) has a significant drop in DO at the end of the monitoring period, probably because of a bottom-disturbing tide at that station or some unexpected disturbance to the sonde device.

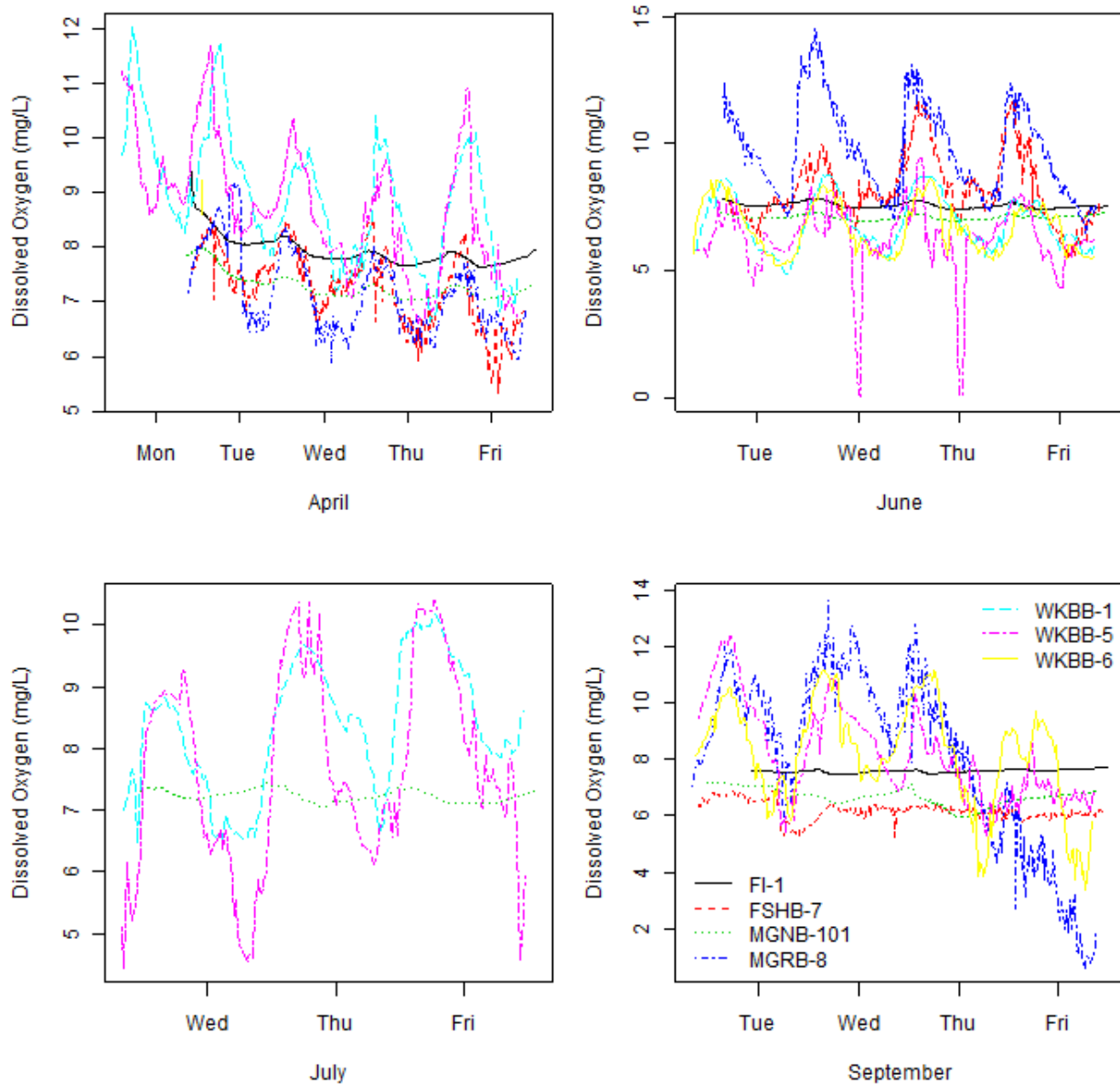

Note: Site locations: freshwater, FI-1 and MGNB-101; tidal streams, MGRB-8 and FSHB-7; mid-bay, WKBB.

**Figure 14. Continuous monitoring data showing DO fluctuation during four sampling events on April 17–20, June 13–17, July 5–8, and September 19–23.**

Additional information on the sediment oxygen demand and chamber measured DO readings are in the *Weeks Bay WQ Study Report* prepared by EPA’s Science and Ecosystem Support Division (USEPA 2011). Similarly, DO readings at the mouth of the Fish River (WB-1) had much lower DO (less than 5 mg/L) than the mid-bay stations. Because the bay is shallow, small variations in sediment oxygen demand can have a dramatic effect on water column DO, varying among and within stations. Sampling variability differs among stations in each month. TN concentrations and turbidity exhibit the least variation during dry season (July and September) or neap tides, but other variables do not show consistent pattern of variation.

## Episodic Nutrient Surveys

Three samples were collected in each survey for each station. Figure 15 shows the mean and standard deviations of nutrient concentrations in each sampling event. The Mobile Bay station (BSBB-1) was also plotted for comparison. It appears that TN, Chl *a*, and turbidity were heavily affected by sampling season/month. TN and Chl *a* were the lowest in the spring and increase to higher levels toward the fall. On the contrary, turbidity values were highest in the spring and lowest in the fall. TP concentrations do not show a pattern of change with seasons. A further comparison of nutrient parameters during ebb and flood tides at same neap or spring tides indicates that tidal disturbance significantly change nutrient concentrations in the mid-bay (Figure 16). Nitrogen and Chl *a* concentration flushing out of the bay during ebb tide are significantly higher ( $p$  less than 0.05) than those pushed into the bay by marine waters. On the contrary, TP and turbidity are much lower during ebb tide than those during flood tide and in the out-bay station. It is possible that heavier marine water with high turbidity flows into the bay from the bottom during the flood tide causing upwelling and mixing, while freshwater inflow from streams during ebb tide mostly flows on the surface and causes less disturbance and thus lower turbidity. Nutrient parameters in the out-bay station were not specifically collected at either ebb or flood tides.

Different from published findings that elevated Chl *a* concentrations during dry season in the Yaquina Estuary, Oregon, was due to marine inflow of Chl *a* concentrations (Brown et al. 2007), our study (Figure 16) did not find higher Chl *a* concentration in the out-bay station than the mid-bay stations during ebb tides. Instead, Chl *a* concentrations flushed out of the bay are significantly higher than the out-bay station, indicating higher Chl *a* concentrations in the mid-bay is a result of photosynthesis in the bay.

The effect of wind speed appears to be a marginally significant ( $p$  less than 0.1) factor to water column clarity (Figure 17). Both turbidity and TSS are much higher under moderate wind speed than light wind speed but Chl *a* and Secchi depth are not different under different wind speed, probably confounded by other factors (e.g., light availability). TN and TP in the water column are not affected by wind speed as well.

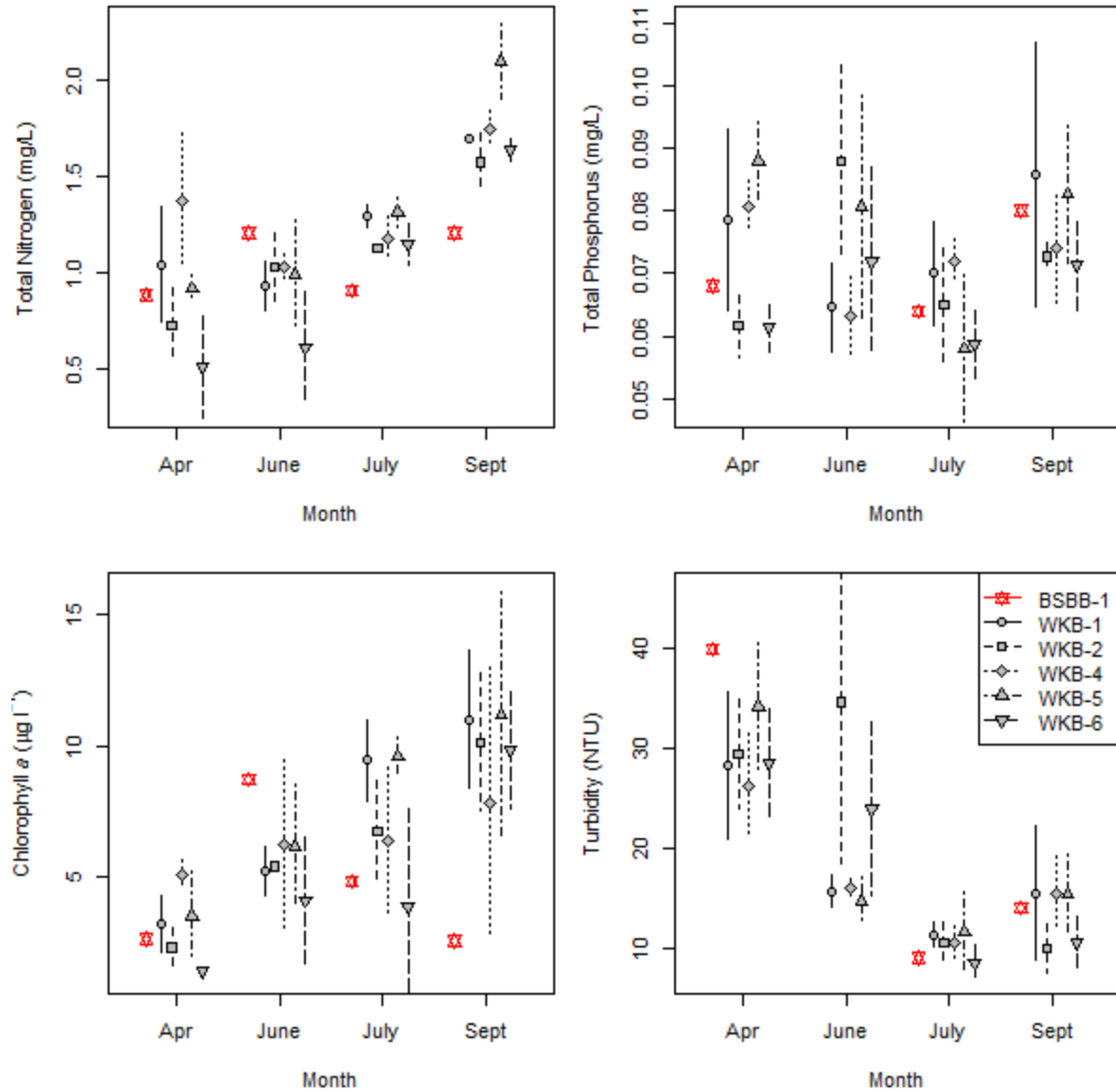

Note: Per sampling event, each site is represented by the mean and ± 1 standard deviation.

**Figure 15. Nutrient fluctuation during the four episodic nutrient survey periods in five mid-bay stations and one Mobile Bay station.**

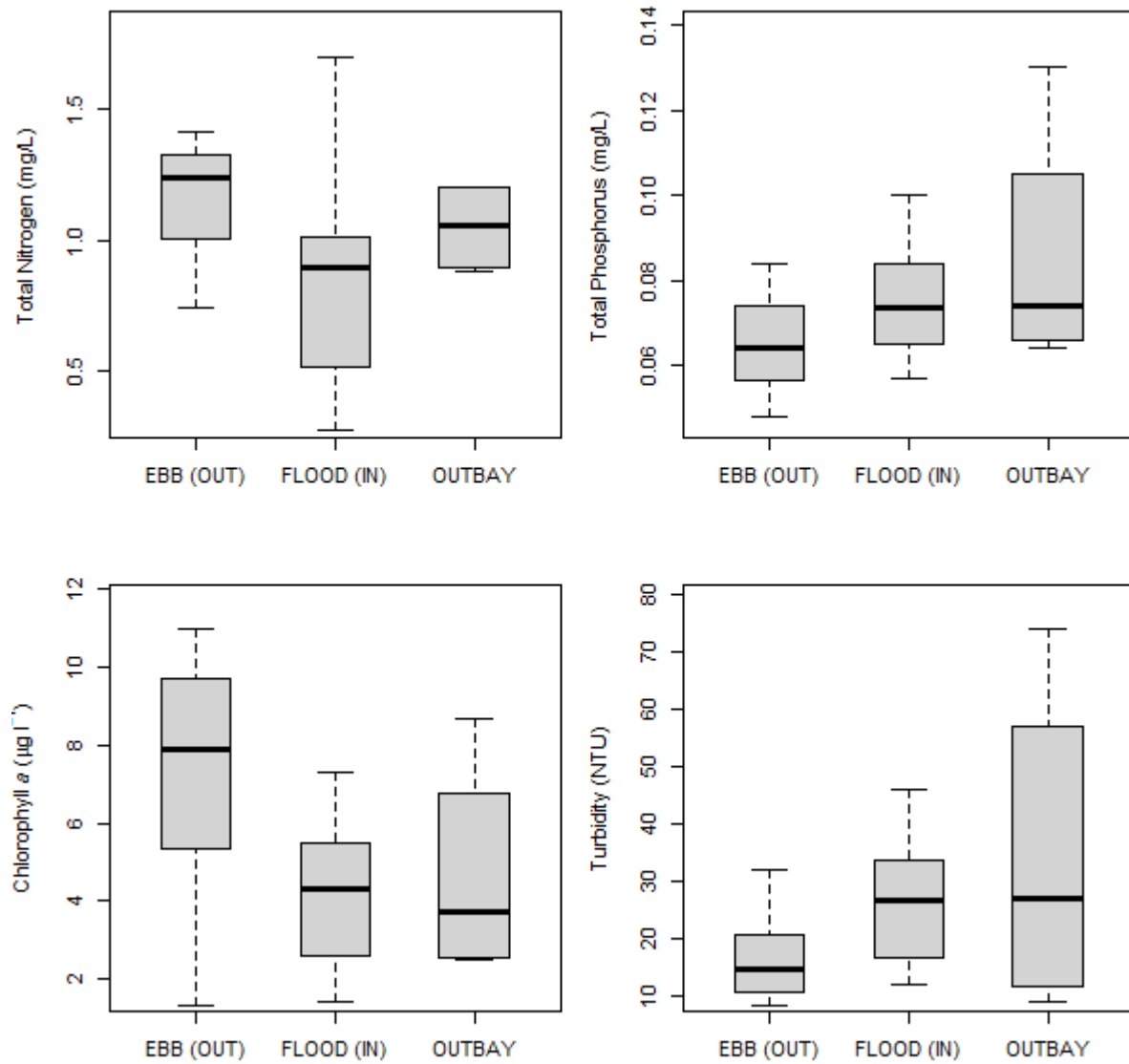
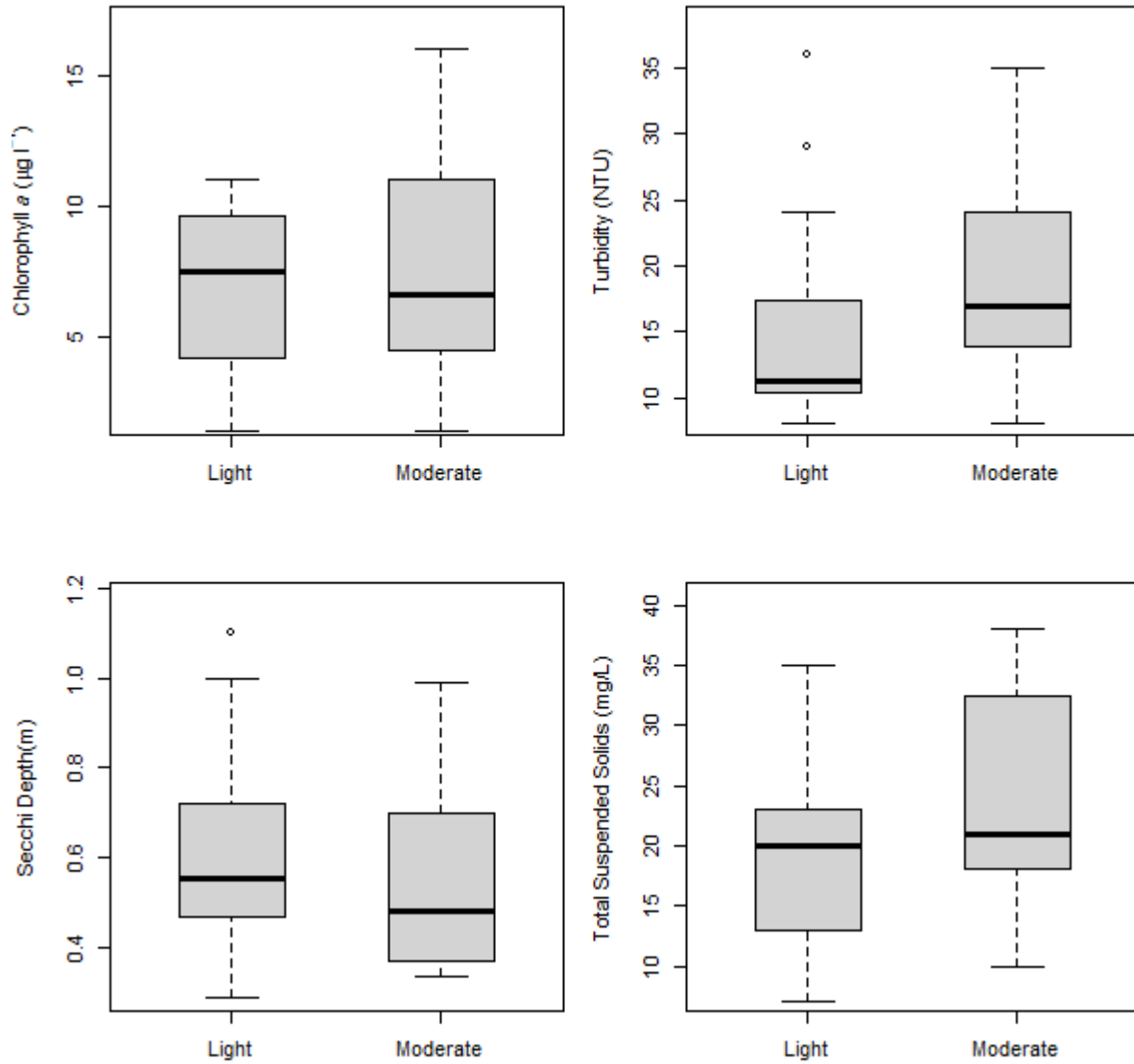

Figure 16. Comparisons of nutrient parameters in the mid-bay during ebb and flood tides and in the out-bay station.



**Figure 17. Effect of wind speed on water column clarity in the mid-bay.**

Variance component analysis (VCA; R Core Development Team [2010] lme4 package for multilevel modeling) reveals different sources of variation for the nutrient variables (Figure 18), which were primarily from month and random sampling error for TN, Chl *a*, nitrate-nitrite, and turbidity. Station locations, on the other hand, are not very different in terms of these variables. There is very little variation in TP concentrations; most is due to random error. Secchi depth differences could be due to differences in station locations. Although stations/month interactions are considered significant in all variables, they explain only a very small amount of variance for all the variables, comparing to the monthly differences and other variations.



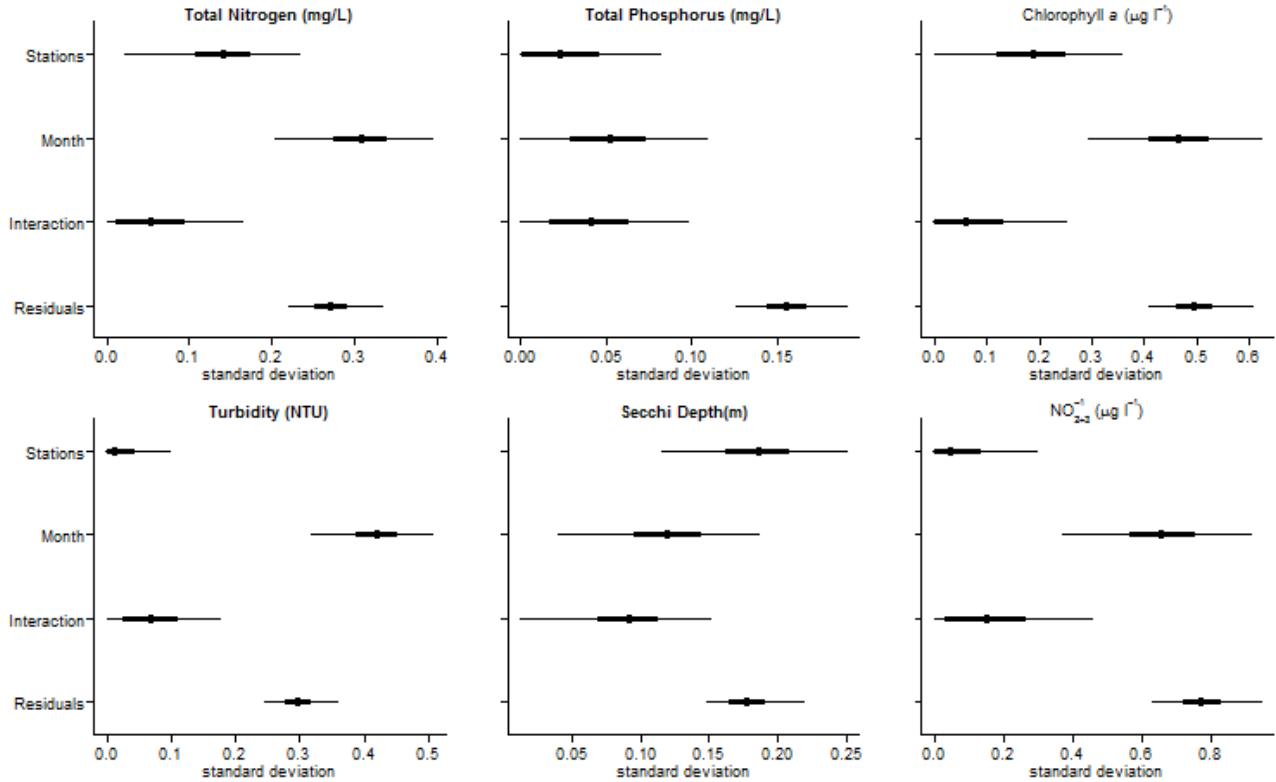

Note: Thick line, 90%; thin lines, 95%. A Markov Chain Monte Carlo (MCMC) simulation was performed to calculate the confidence interval for the standard deviations.

**Figure 18. Variance component (standard deviations) and their confidence limits for the episodic nutrient survey samples.**

VCA confirms that temporal variation (by month) of nutrient variables is the major source of variation, along with random errors that cannot be explained by either station or month. Monthly variation of TN and Chl *a* is not surprising because upstream nutrient loadings into the mid-bay vary by month, and nutrient concentrations in the mid-bay could be strongly influenced by flow, storm event, and seasonal tides during different months. Strong variation among stations in Secchi depth could be associated with station depth and station-specific measurement errors. Therefore, Secchi depth might not be a good estimate of phytoplankton biomass and responses to nutrient increases.

## 6.2 Monthly Variation of Water Quality Parameters

To examine how the meteorological condition in the Weeks Bay area would affect the water quality conditions in the mid-bay, the meteorological data were downloaded from the nearby Safe Harbor Met Station of CDMO/NERRS. The daily cumulative participation and daily maximum wind speed are shown in Figure 19. The rainy season occurs in the late winter and earlier spring (January–March) with highest rainfall days in the early March and strongest windy days in the early February. Summer (July–September) is the dry season with relatively mild wind.

In addition to the episodic surveys, temperature, salinity, chloride, and DO were measured throughout the year at the five mid-bay stations and the Mobile Bay station. Spatial heterogeneity is less obvious than the monthly temporal variation (Figure 20). The Mobile Bay station (BSBB-1) probably has slightly higher salinity values and chloride concentrations, but has comparable temperature and DO with those stations of the mid-bay. Water temperature is highest in summer (July–August) and lowest in winter (November–January). The mean salinity at a station in the bay is associated with distance to the outlet of Mobile Bay, which is highest at the outlet station (WKBB-2) and lowest at the river inlets (WKBB-4 and WKBB-5). The highest chloride concentrations and salinity occur toward the end of the year during the dry season and the lowest salinity occurs during spring wet season (April–May) when stream runoff diluted bay salinity.

Differences in DO concentrations are less obvious among stations and could vary during different sampling events. In general, WKBB-4 (Magnolia River mouth) has higher DO than most of the other stations in mid-bay. Not surprisingly, DO is lowest in the summer (August) when temperature is the highest, as DO is least soluble at high temperature. DO concentrations are highest in the late winter when temperature is lowest and Chl *a* concentrations reach the highest level (Figure 21).

Because spatial variability among stations is relatively low, we combined the five mid-bay stations to examine the monthly variation of nutrient variables during the 11-month period (Figure 21). Surprisingly, the highest concentrations of nutrients, Chl *a* and turbidity all occur in February, which could indicate potential spring flow from streams and surface runoff to the bay or bottom upwelling in the bay in early spring. The high wind speed and storm event in early February (Figure 19) could partially explain the bay bottom disturbance and high nutrient and turbidity during the event. However, this observed seasonal pattern was based on only one year of data, and thus, might not reflect true seasonal patterns in different years. Further examination of long-term and multiple years of data are discussed in the next section.

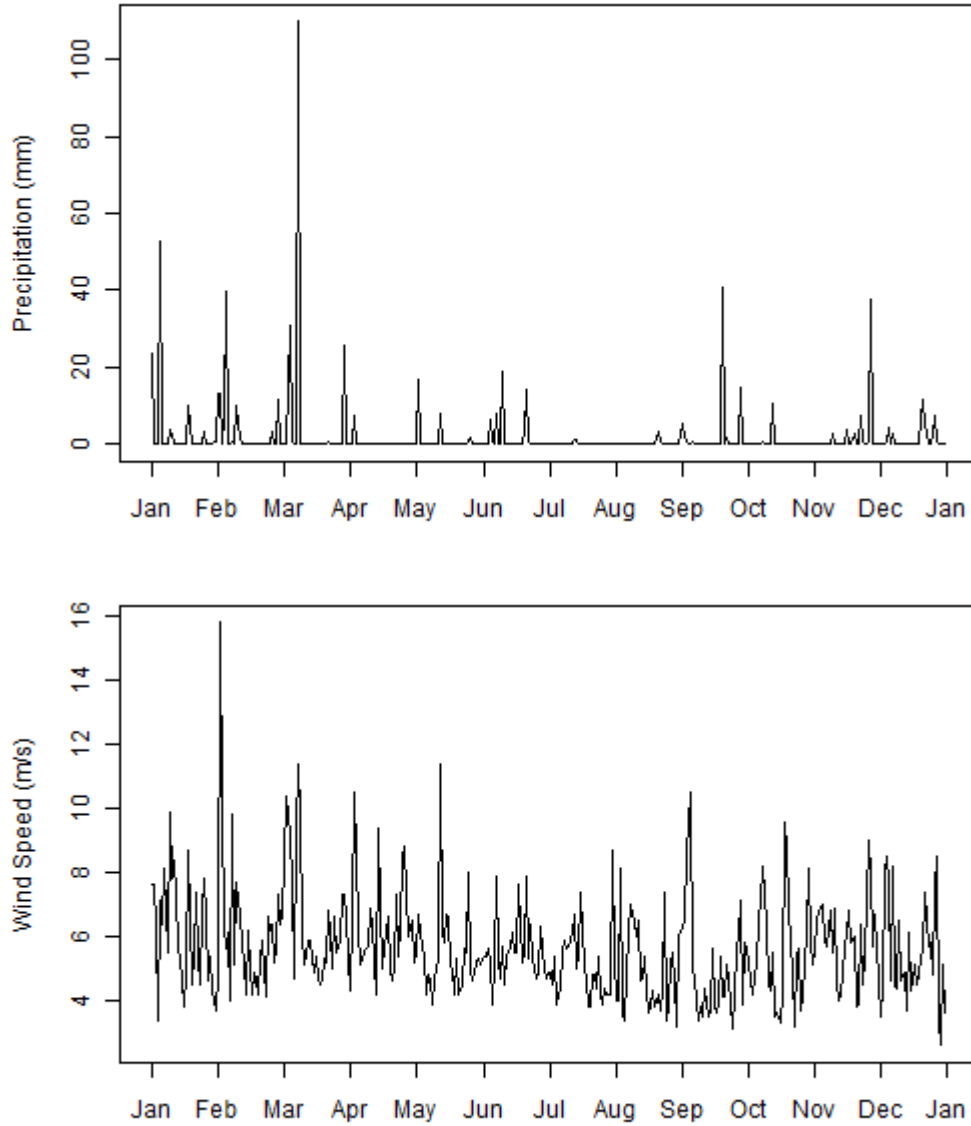
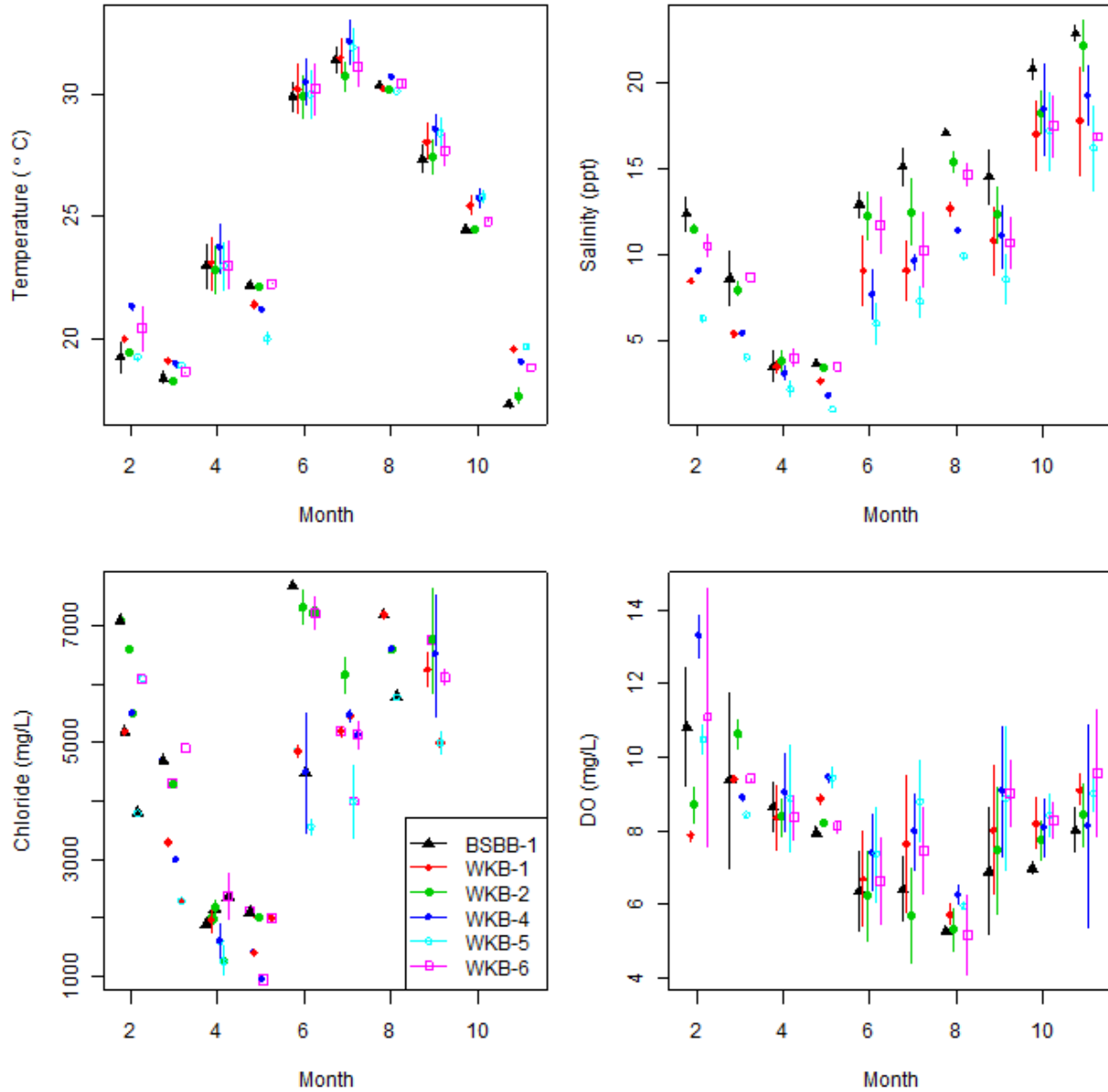
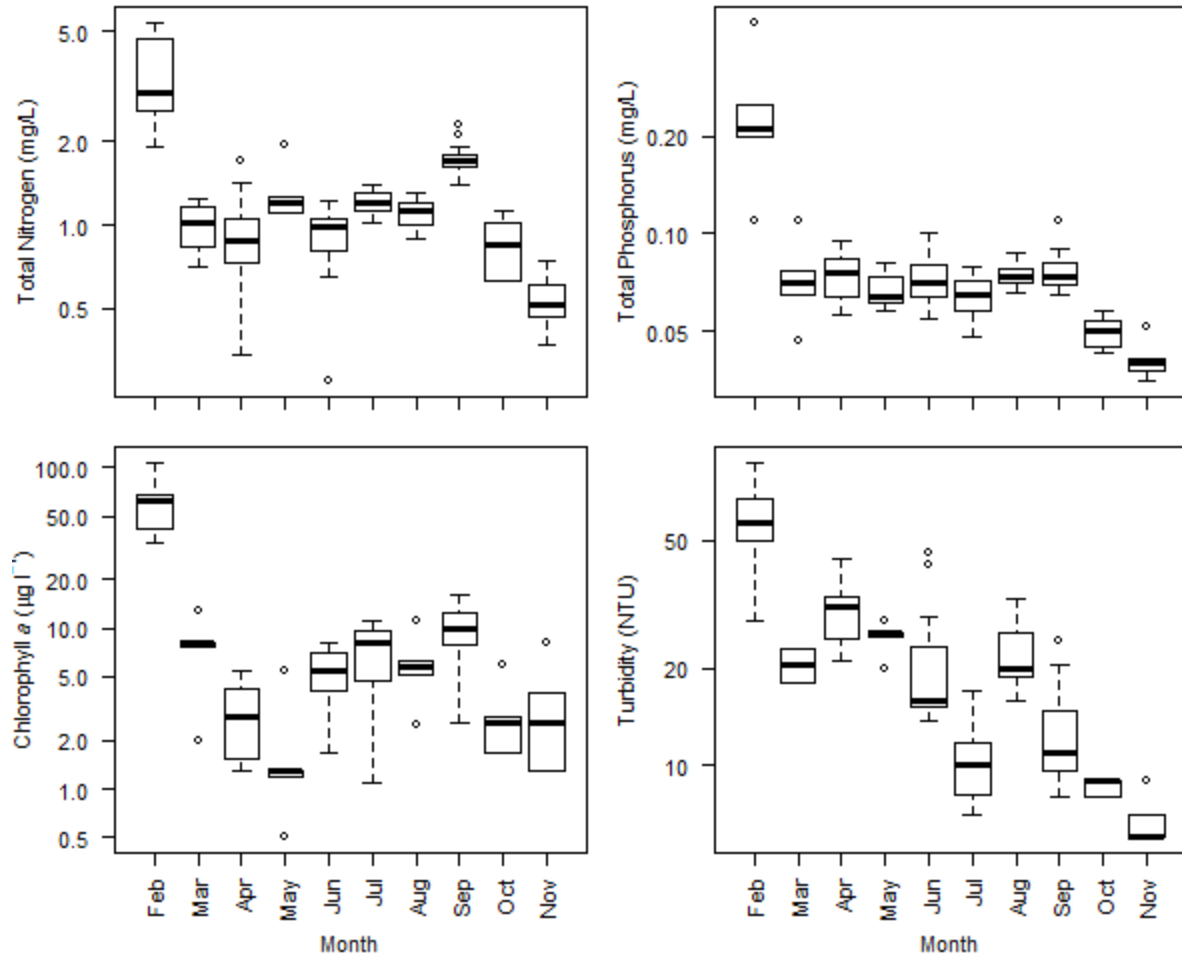

Figure 19. Daily cumulative precipitation and maximum wind speed in 2011.



Note: Per month, each site is represented by the mean and  $\pm 1$  standard deviation.

**Figure 20. Seasonal variation of environmental variables in the bay (2011).**

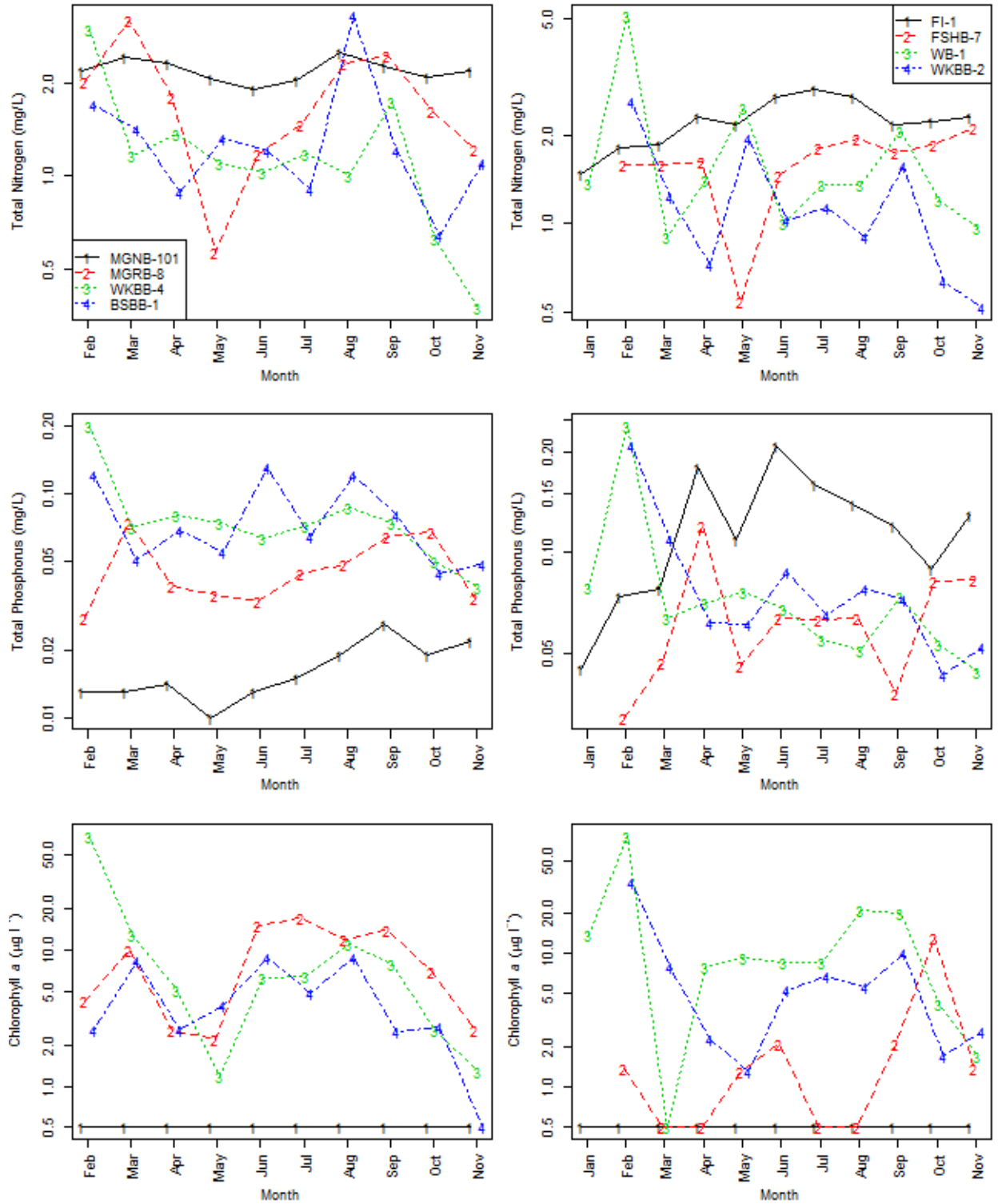

**Figure 21. Seasonal variation of nutrient concentrations in Weeks Bay mid-bay stations (2011).**

Figure 22 was intended to link the upstream flows from two rivers with nutrient spikes observed in the mid-bay stations. No significant nutrient inflow in February has been observed from the two rivers into the bay (Figure 22), although the mid-bay nutrient concentrations show a dramatic spike in that month.

Nothing in these analyses indicates that elevated nutrient concentrations in Weeks Bay in February are caused by loadings via stream runoff. Instead, salinity in February is relatively high (5–10 ppt higher) compared to the March and April rainy season (lowest of the year), but not as high as in the fall, dry season (10 ppt lower). So the high nutrients, Chl *a* concentrations and turbidity in Weeks Bay in early February are likely more strongly associated with wind-driven, bottom upwelling in the bay, or mixing from Mobile Bay according to the 2011 study.

Several studies (e.g., Roegner et al. 2002; Brown et al. 2007) have suggested that Chl *a* is transported into estuaries during the dry season along the coasts of Oregon and Washington. They found high salinity during the dry season and relatively high Chl *a* concentrations in the estuaries. Brown et al. (2007) found that a 60 percent reduction in Chl *a* occurs between successive flood and ebb tides. However, the ADEM study does not show the same pattern (Figure 23) as most of the high Chl *a* samples occur during low salinity conditions in the mid-bay. Also, Chl *a* concentrations in the out-bay are seldom higher than in tidal streams and mid-bay locations (Figure 22, bottom left).



Note: Magnolia River, left; Fish River, right. 1–4 indicate upstream to downstream sites.

**Figure 22. Seasonal fluctuation of stream nutrients from two freshwater inflows into Weeks Bay**

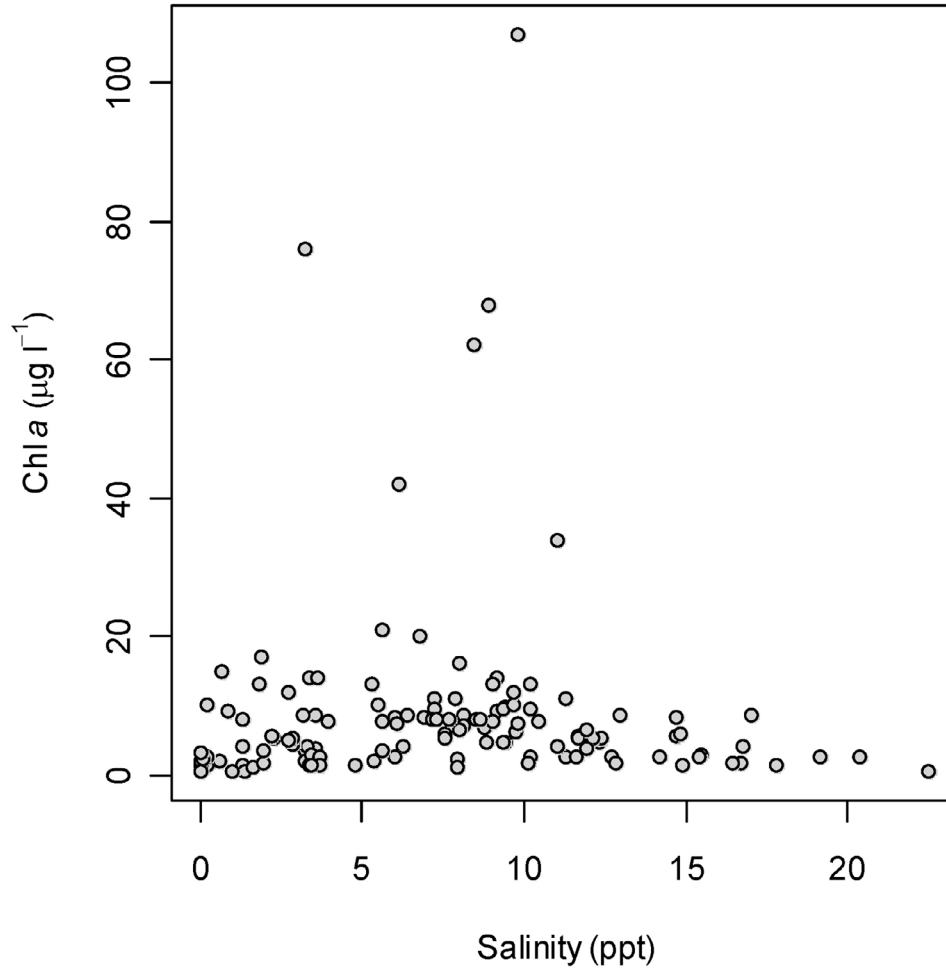

**Figure 23. Relationship between salinity and chl a concentrations in the mid-bay.**

The difference in water quality from the riverine freshwater inflows is primarily due to TP concentrations, whereas TP in the Fish River is much higher than in the Magnolia River and in mid-bay; but TN concentrations are equally high in both rivers (Figure 22). When going downstream, TOC, Chl *a*, and turbidity concentrations all rise dramatically (Figure 3, Figure 7, Figure 8). Water column average DO concentrations are mostly greater than 5 mg/L in freshwater streams and in mid-bay in all months in this study, except that DO decreased to less than 5 mg/L for October in both tidal river sites (MGRB-8 and FSHB-7) (Not shown) where respiration could probably rise to the highest level during fall dry season (Brown et al. 2007).

## 6.3 Long-Term Continuous Monitoring

Additional monitoring data for Weeks Bay mid-bay stations were downloaded from the NERRS/CDMO. Meteorological data is available from one station near the mouth of Fish River. Air temperature, humidity, photosynthetically active radiation, wind speed and direction, and precipitation were monitored in 15-minute intervals. This weather station is close to the station WK-1 and was monitored from 2008 to 2010 but was discontinued in 2011. Similarly, DO, pH, salinity, conductivity, turbidity, and temperature have been continuously monitored in 15-minute intervals over the past 5 years (2007–2011) or so, for four stations approximating the current stations of WK-1 (mouth of Fish River), WKBB-1 (central bay), WKBB-2 (outlet of the bay), and WKBB-4 (mouth of Magnolia River). The daily minima and means were calculated to examine temporal variability. All water quality datasondes (YSI) were deployed at a known distance from the bottom, so that the sonde probes are between 0.25 and 0.5 meters above the substrate at each site.

### Meteorological Conditions

The meteorological data were used to examine the potential effect of wind and rainfall events on water quality conditions. We are most interested in wind speed and direction and precipitation and their potential effect on water column disturbance and nutrient loadings in the bay.

Not surprisingly, the average monthly wind speed is highest in the spring (March) during 2008–2010 but drops to the lowest in the summer months, although varies slightly by years (Figure 24). The year 2009 is a relatively lower wind year when compared to the other two years, almost having lower wind speed during all months than the other two years.

The monthly total rainfall at the station is much more variable across different years and show less seasonal pattern (Figure 24). Late winter and early spring tend to have more rainfall and early summer tend to be dry in the region but do not show consistent pattern.

### DO Fluctuation

It is generally recognized that water column DO concentrations follow a strong diurnal pattern due to net photosynthesis in the day and respiration at night. The median DO diel fluctuation was 3.5 mg/L at the four stations in Weeks Bay, with 90 percent of the diel fluctuation between 0.9–7.8 mg/L. In addition, a strong seasonal pattern was also observed for daily minimum DO in all four stations (Figure 25). DO tends to be lowest in summer months and highest in winter, which is consistent with observed monthly pattern from this survey (Figure 20). The seasonal differences between winter and summer could be 8–10 mg/L at the same sampling locations (Figure 25). Daily minimum DO concentrations in many of the summer seasons approached 0 mg/L at all four locations.



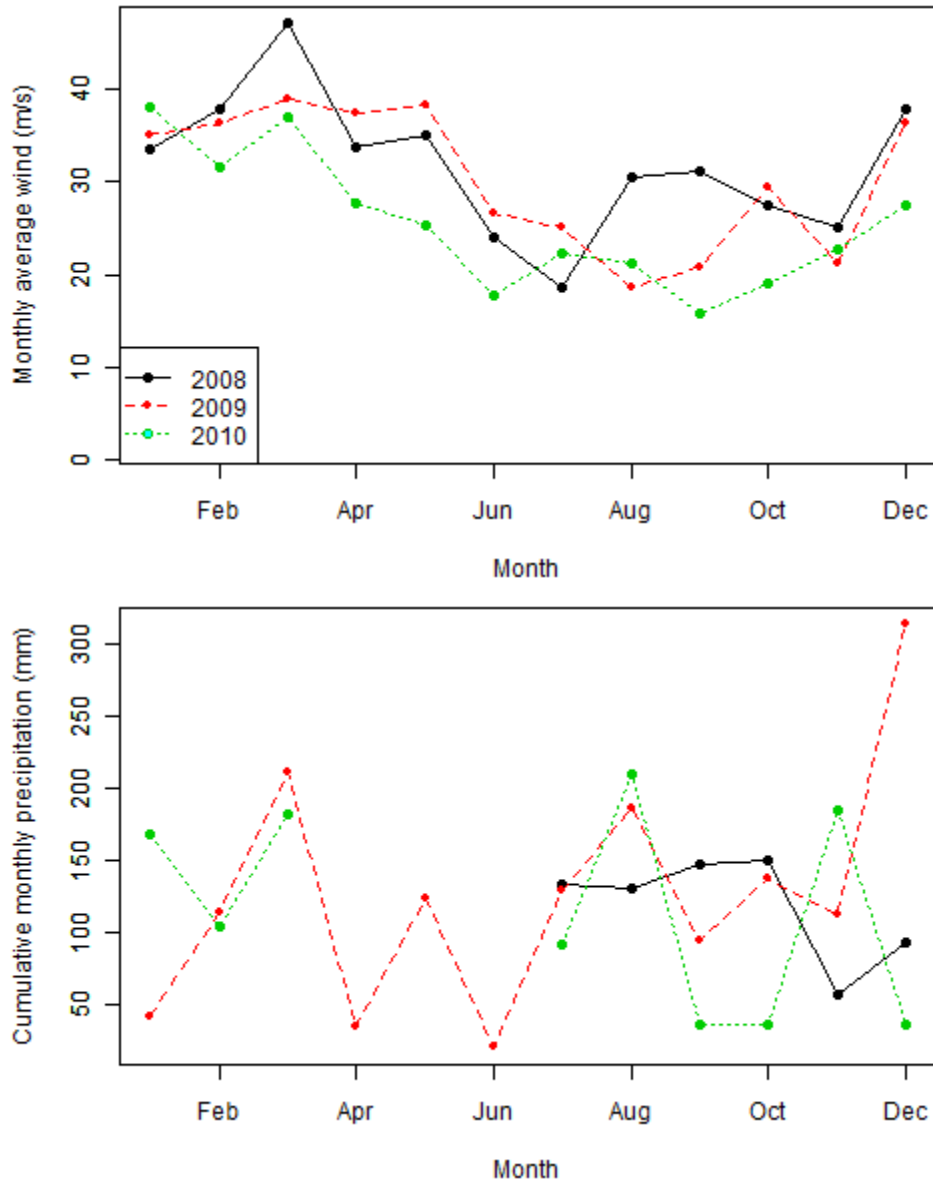
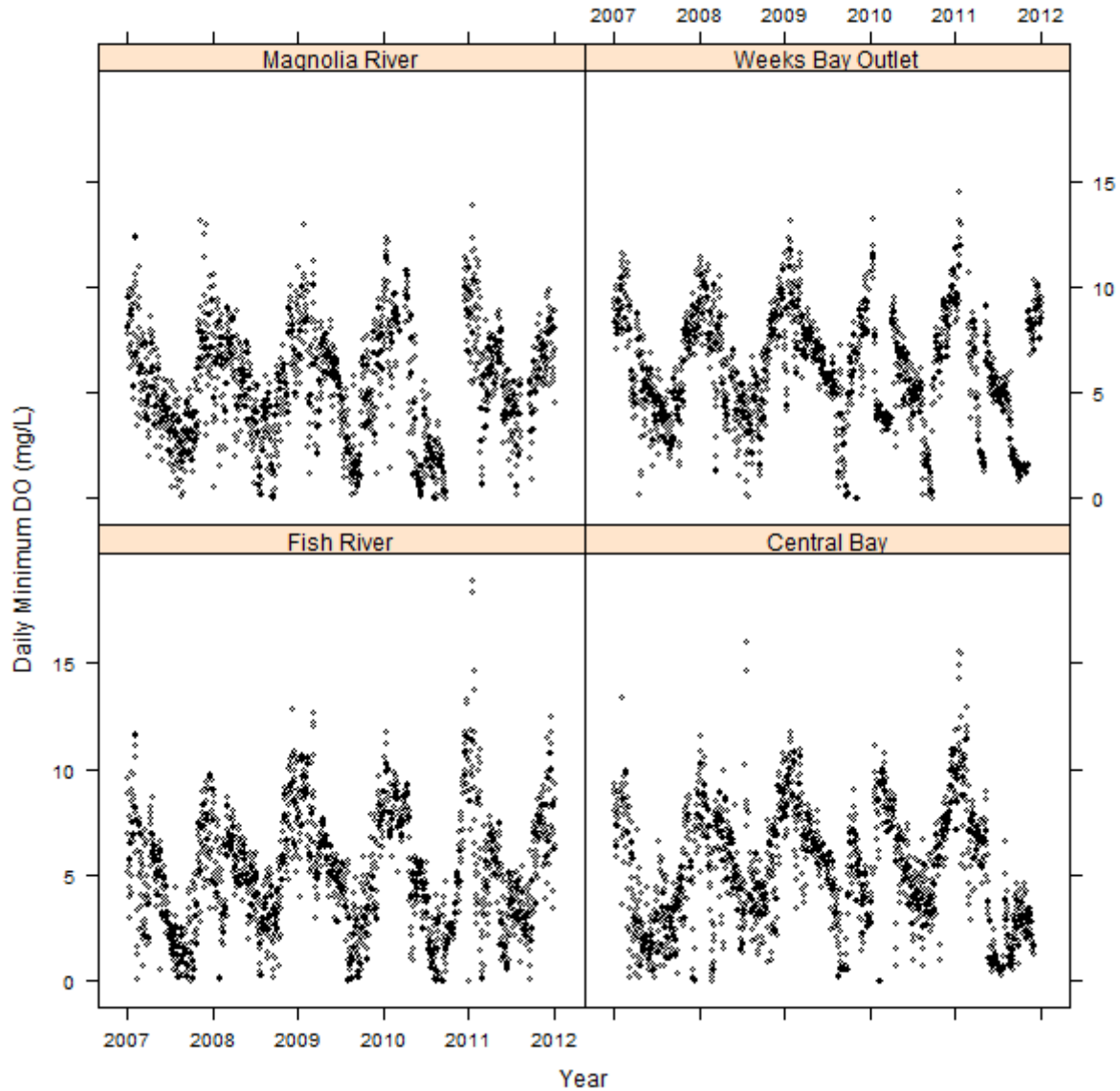

Figure 24. Monthly average wind speed (meter/second) and monthly cumulative rainfall (mm) at the Weeks Bay weather station in 2008–2010 (NERRS/CDMO).



**Figure 25. Daily minimum DO fluctuations in four mid-bay stations in 2007–2011 (NERRS/CDMO).**

The observed daily minimum DO pattern (Figure 25) can be decomposed into three components (Figure 26): a seasonal component, a trend component, and a residual component (Cleveland et al. 1990). The decomposition was performed by finding the seasonal component based on loess smoothing (R Core Team 2010; Cleveland et al. 1990). After the seasonal values are removed, the remainder was smoothed to find the overall daily DO minima trend over a 5-year span. The trend was then removed from the seasonal component and added to the trend component. This procedure was iterated a few times. The remainder component represents random sampling error in the monitoring data (observed, minus seasonal and trend components). The decomposed seasonal component of daily DO minima at the center of the bay was clearly highest in January and declined to the lowest level in August. Daily DO minima at other stations follow a similar seasonal pattern.

Both long-term daily DO means and minima varied from year to year but generally followed similar pattern for all four stations (Figure 27). Overall, the daily minimum DO was lowest at Fish River station, but much higher near the outlet of Weeks Bay.

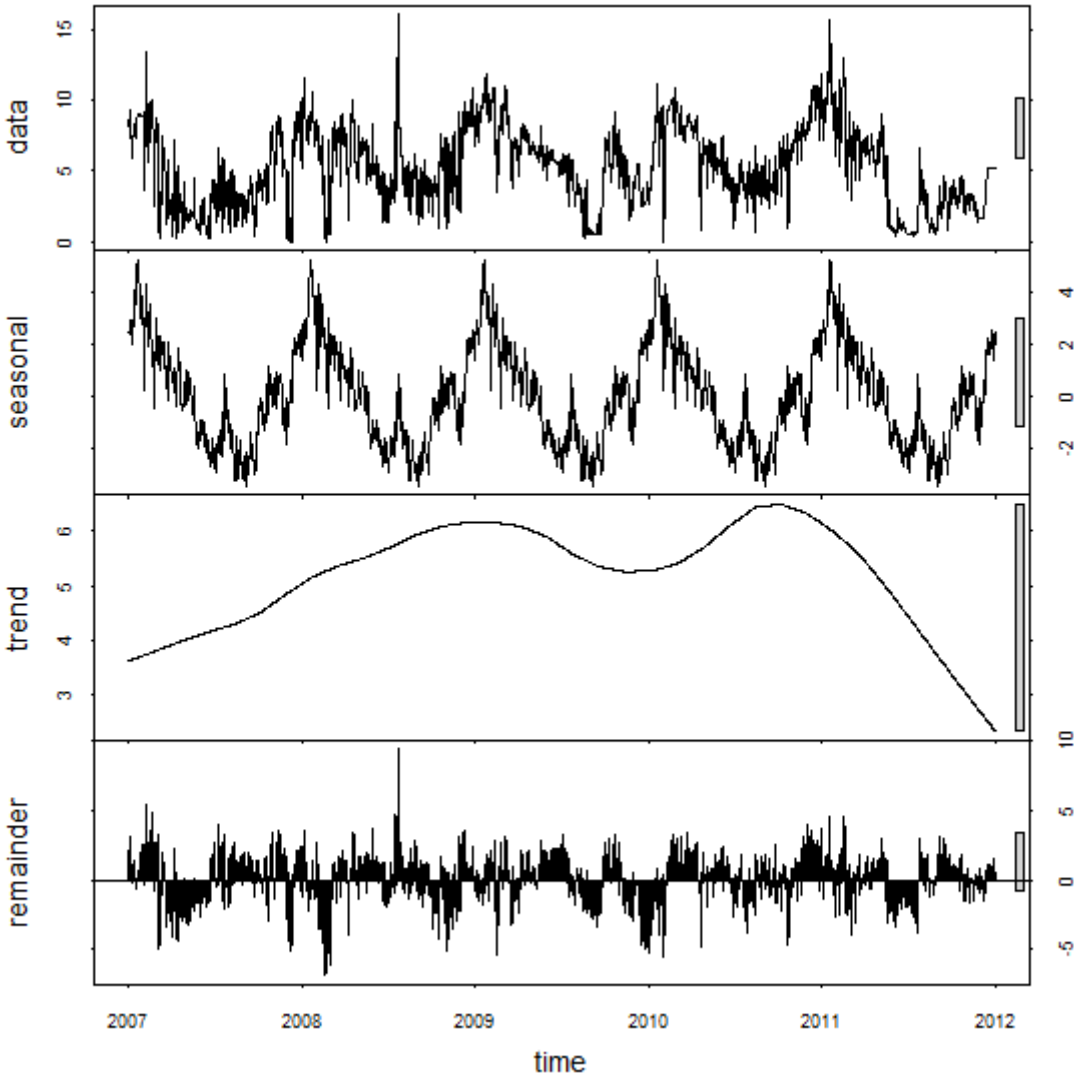

Note: The four panels (from top to bottom) show the observed DO fluctuation, the extracted seasonal pattern, the moving average trend, and the autoregressive residuals.

**Figure 26. A time series decomposition of daily minimum DO concentrations at the center of the bay in 2007–2011.**

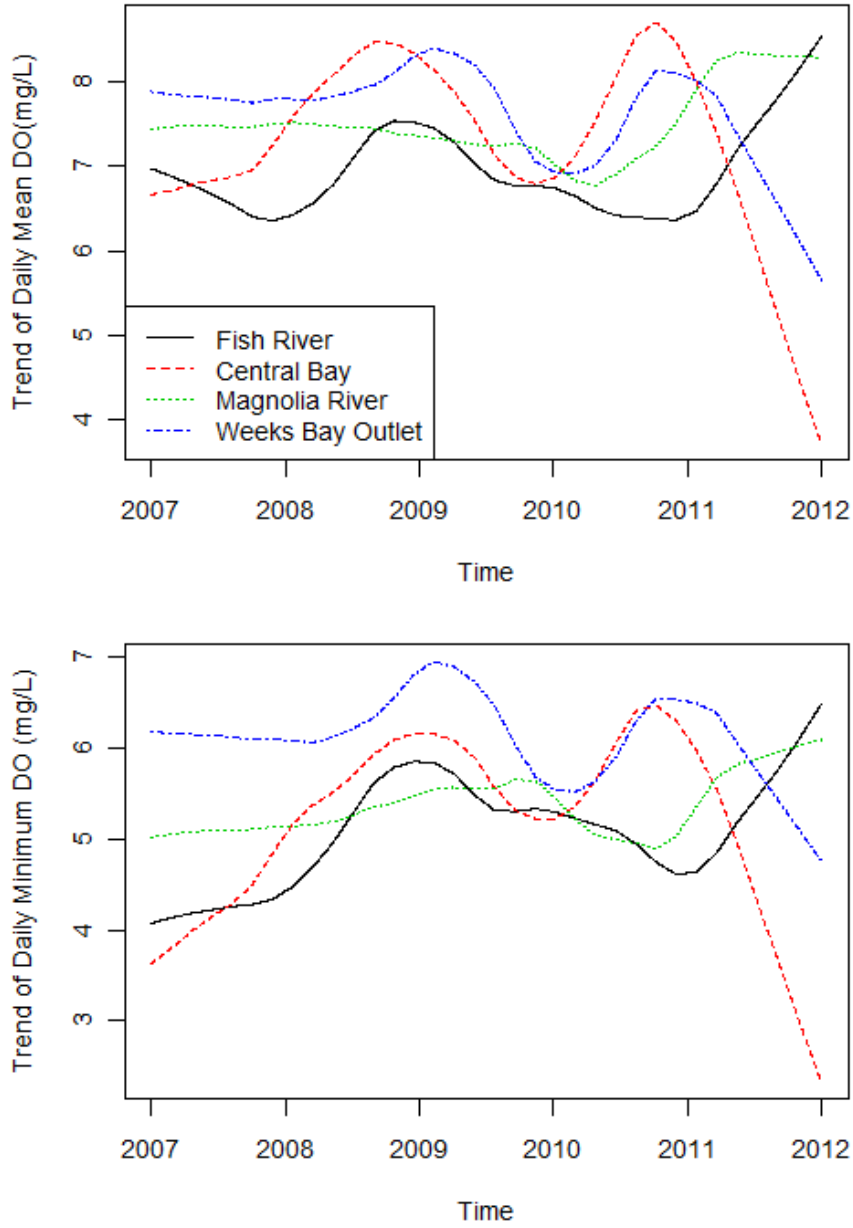

Figure 27. Daily minimum concentrations of DO at four mid-bay stations of Weeks Bay (data from NERRS/CDMO).

## Salinity Fluctuation

Because of tidal and freshwater runoff, salinity in the Weeks Bay also follows a pattern of diurnal fluctuation. The diel fluctuation of salinity close to the two rivers were weaker, with median values of 2.3 (Fish River, 90 percent between 0.5–6.15 ppt) and 2.6 ppt (Magnolia River, 90 percent CI = 0.7–6.9 ppt), respectively. The center (median 4, 90 percent CI = 0.8–8.5) and the outlet (median 4.3, 90 percent CI = 0.9–8.8) of the bay had larger fluctuations because they are more strongly affected by tidal activities.

The daily mean salinity follows a strong seasonal pattern as well (Figure 28). All four stations follow similar long-term trends, so the decomposed components of the observed pattern at the center of the bay represent the general pattern in the bay (Figure 29). Salinity fluctuates 14–15 ppt seasonally at the four stations and the mean trend at the center of bay ranges from 6–16 ppt in different years. The highest salinity is in the later fall during the dry season (September–October), while the lowest salinity is during the spring wet season (March–May).

## Turbidity Fluctuation

Strong tidal activities and storm events cause upwelling and mixing of sediments in most parts of the bay. However, both diurnal and seasonal variation is less strong, as observed for salinity and DO (Figure 30). The daily mean turbidity follows a weak seasonal pattern, but it shows mostly monthly variations with peak in the early spring and then levels off slightly, then reaches another peak in the late summer (Figure 31).

## Nutrient Fluctuation

Three nutrient parameters, i.e.,  $\text{NH}_4$ ,  $\text{NO}_{2+3}$ , and Chl *a* (fluorophotometric method), have been monitored monthly for 11 years (2002–2012) at the same four stations as were monitored for other water quality parameters. Although orthophosphate-phosphorus (ortho-P) was also monitored at the same locations, the majority of these values were under detection limits (90 percent CI less than 0.01 mg/L). The observed trends were mostly driven by multiple detection limits; therefore, the ortho-P was not used here for trend analysis.

## Chl *a* Concentrations

Eleven years of monthly monitoring of Chl *a* concentrations at four Weeks Bay stations reveals similar trends among the stations (Figure 32). The long-term Chl *a* concentrations show a large increase in 2006 from previous years and then remain stable in the most recent 5 years. Algal biomass has increased dramatically at the Fish River station in recent years, exhibited by much lower Chl *a* in the early 2000s than other Weeks Bay stations to a level comparable with other stations in recent years. This Fish River station is slightly upstream from WK-1, where nutrient monitoring data are available from only 2002–2004. A comparison of those Chl *a* concentrations from 2002–2004 (NERRS data) indicates that station WK-1 has much higher algal biomass than this Fish River station.

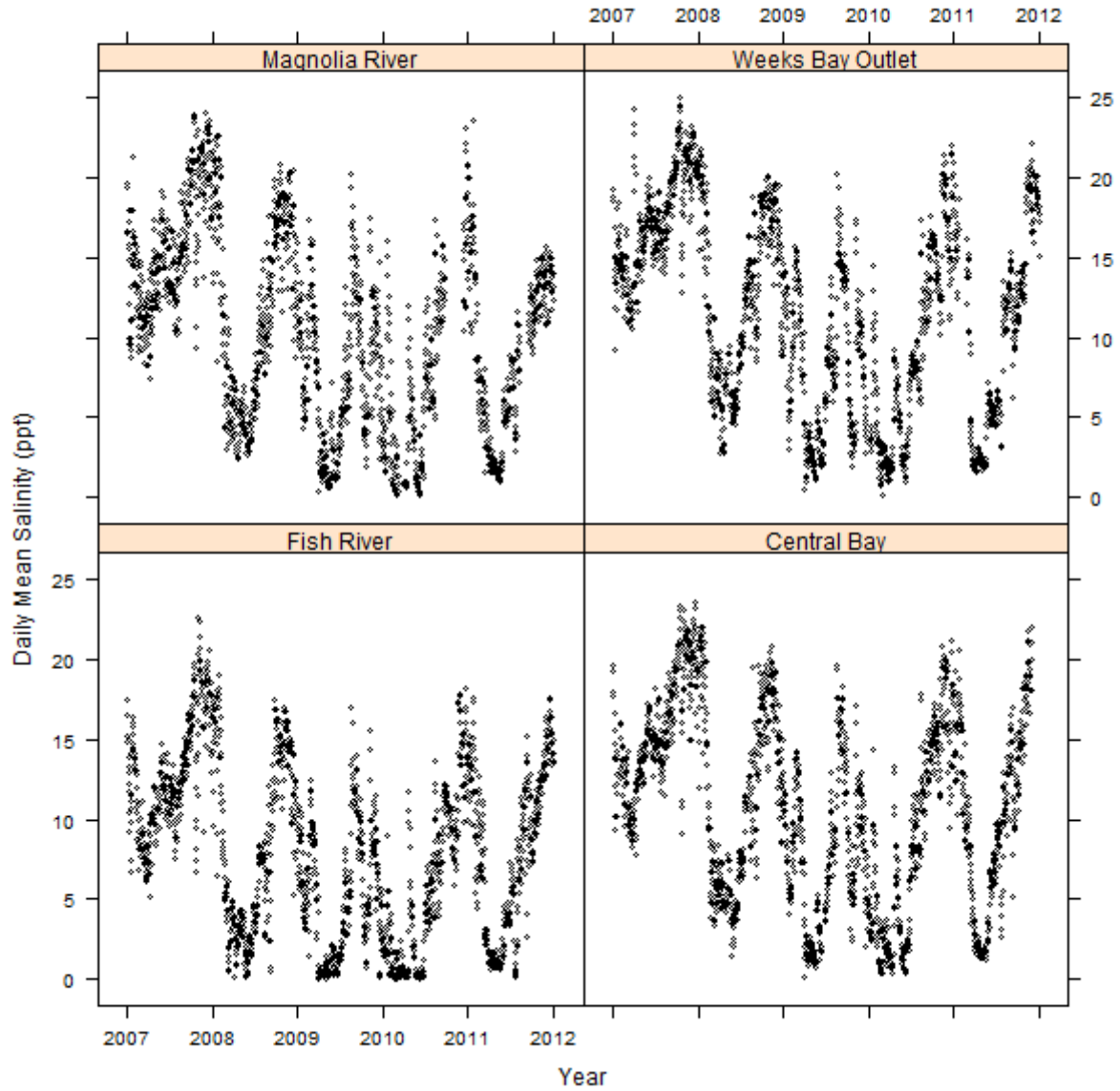
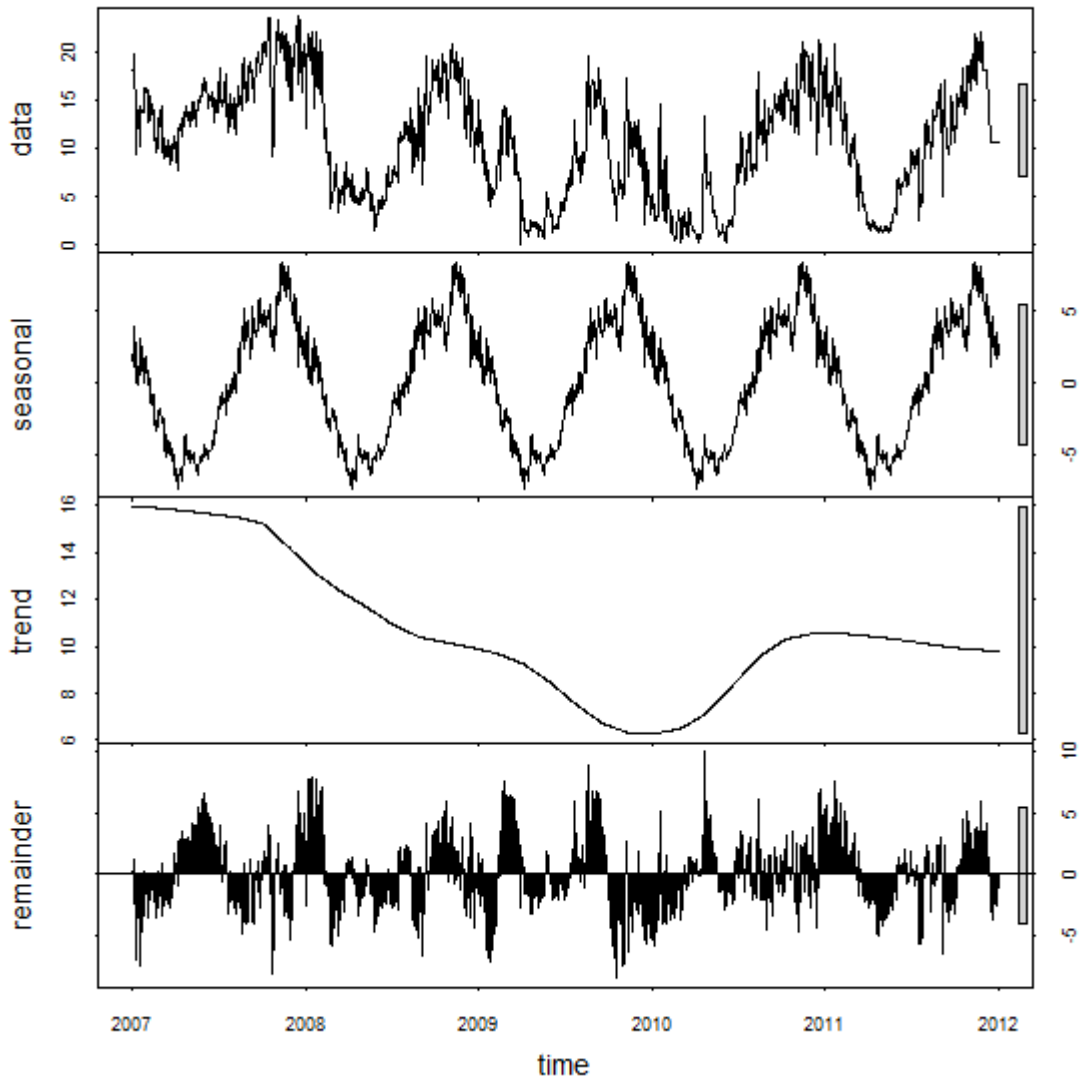
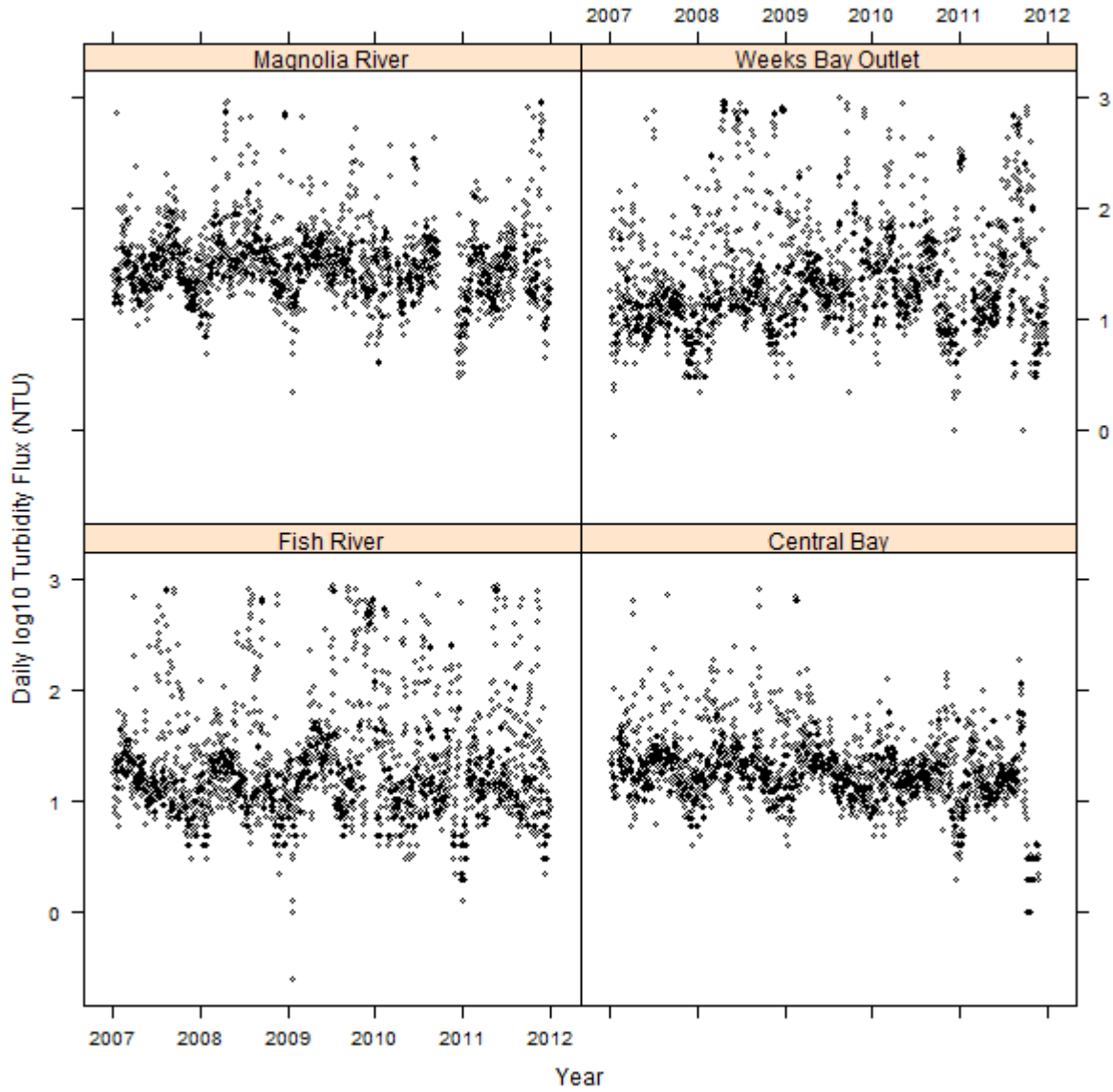

Figure 28. Long-term daily mean salinity in four Weeks Bay stations (2007- 2011) (data from NERRS/CDMO).



Note: The four panels (from top to bottom) show the observed salinity fluctuation, the extracted seasonal pattern, the moving average trend, and the autoregressive residuals (data from NERRS/CDMO).

**Figure 29. A time-series decomposition of daily mean salinity at the center of Weeks Bay (2007–2011).**



Note: Each data point represents the 24 hour average value of turbidity measured by the YSI sonde.

Figure 30. Long-term daily mean turbidity fluctuation at four stations (2007–2011).



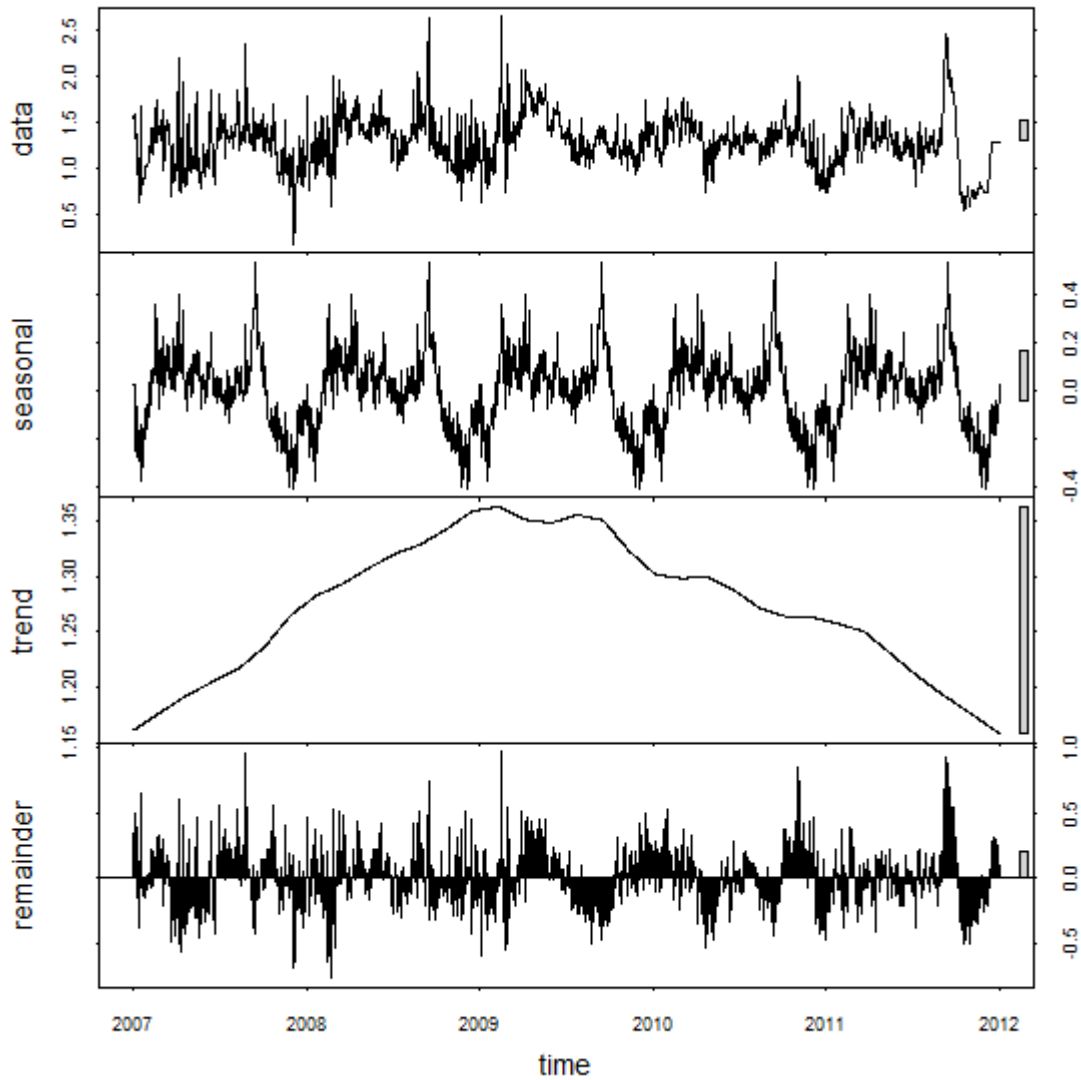

Note: The four panels (from top to bottom) show the observed turbidity fluctuation, the extracted seasonal pattern, the moving average trend, and the autoregressive residuals.

**Figure 31. A time series decomposition of daily mean turbidity (log<sub>10</sub> scale) at station WKBB-1 during year 2007–2011 (data from NERRS/CDMO).**

The extracted seasonal components show less distinct trends (smaller magnitude of fluctuation) than the long-term variation (Figure 32), but they do show slightly higher algal biomass in the spring (April–June) and lower late summer biomass in the bay stations. Also, a winter bloom occurred in three of the stations but is less consistent than observed spring blooms. The observed seasonal patterns are also confirmed by our study in 2011 (Figure 21).

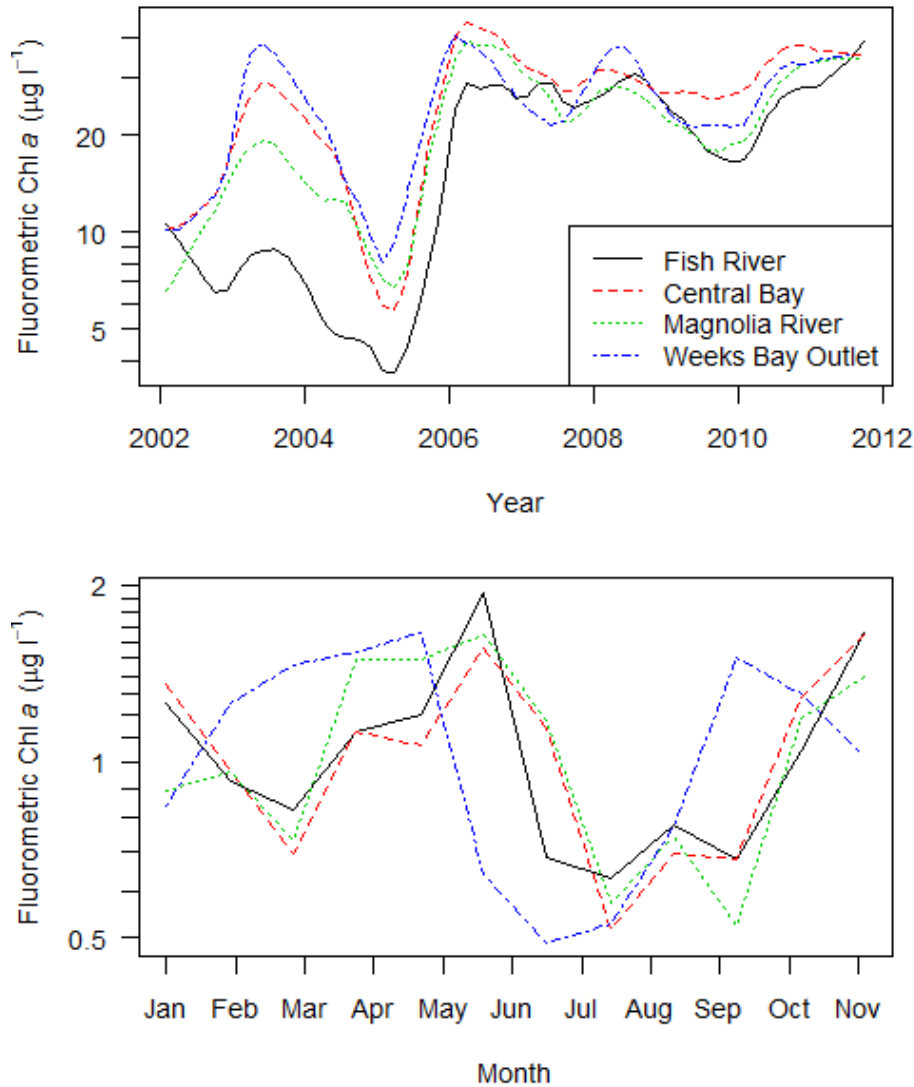

Note: The lines are components of long-term and seasonal components from time series decomposition.

**Figure 32. Long-term smoothing and seasonal variation of Chl a concentrations in four mid-bay stations decomposed from 10 years of observed data (data from NERRS/CDMO).**

### NO<sub>2+3</sub>-N concentrations

Ten years of monthly monitoring of NO<sub>2+3</sub>-N concentrations in four Weeks Bay Stations reveals similar trends for all four stations (Figure 33). The long-term NO<sub>2+3</sub>-N concentrations are highest in the two stations closest to the rivers where upstream nitrogen loadings directly leads to higher NO<sub>2+3</sub>-N concentrations in these streams. The NO<sub>2+3</sub>-N concentration is diluted at the center of the bay and then further diluted by the marine water. The extracted seasonal components show higher concentration in the fall through winter months and low concentrations in the spring.

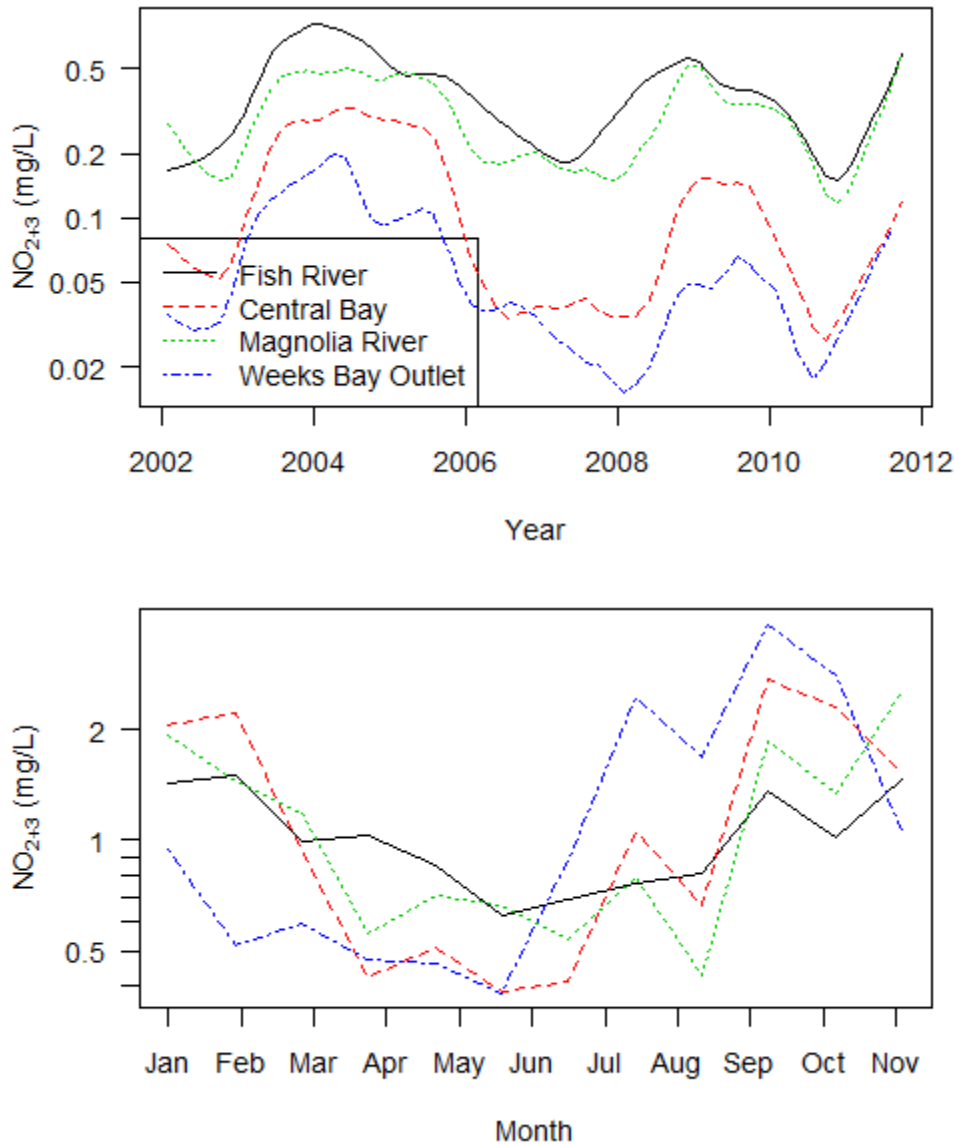

Note: The lines are components of long-term and seasonal components from time series decomposition.

**Figure 33. Long-term smoothing and seasonal variation of NO<sub>2+3</sub> concentrations in four mid-bay stations decomposed from 10 years of observed data (data from NERRS/CDMO).**

### NH<sub>4</sub> + Concentrations

Ten years of monthly monitoring of NH<sub>4</sub> + concentrations in four Weeks Bay stations reveals similar trends for all four (Figure 34). The long-term NH<sub>4</sub> + concentrations fluctuate yearly; the extracted seasonal components are site specific and do not show a common trend.

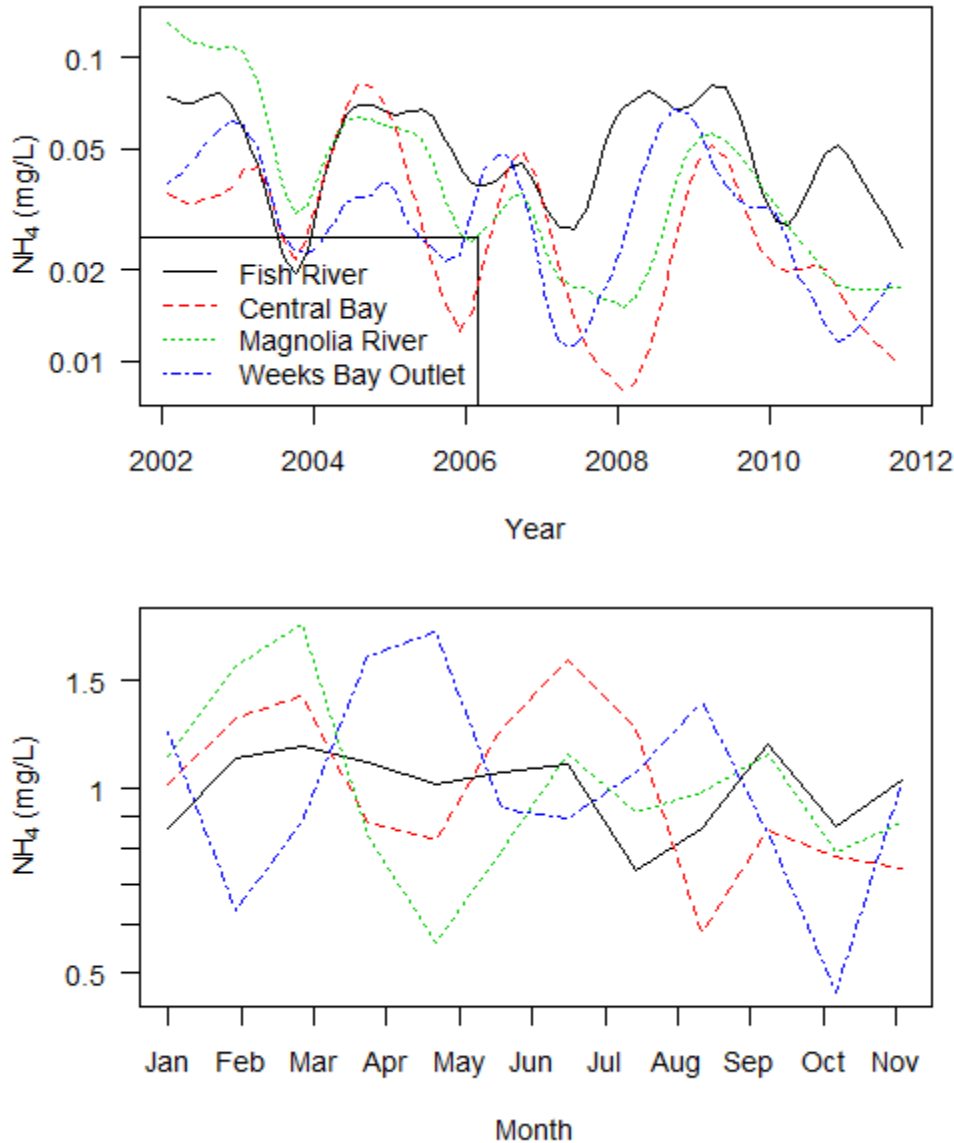

Note: The lines are components of long-term and seasonal components from time series decomposition.

**Figure 34. Long-term smoothing and seasonal variation of NH<sub>4</sub> concentrations in four mid-bay stations decomposed from 10 years of observed data (data from NERRS/CDMO).**

## 6.4 Spatial Variation: Vertical Profile

The depths of all of the mid-bay stations are less than 2 meters, lessening the likelihood of stratification. The deepest locations are at the Fish River sites (e.g., FSHB-7), which could reach 8 meters during the high-flow season (e.g., April). One station at the mouth of Fish River (WK-1) could reach 4 meters.

Conductivity, a surrogate of salinity measurement, was monitored at different depths in the mid-bay locations and tidal streams during each month. Change of salinity at various depths indicates stratification to some extent at various locations. A detailed examination of the depth profile by month (Figure 35) indicated that the stratification occurred mostly in the fall (August–November) at both the tidal streams and mid-bay locations with minimum stream flow. Salinity measurements are highest in the fall low-flow season.

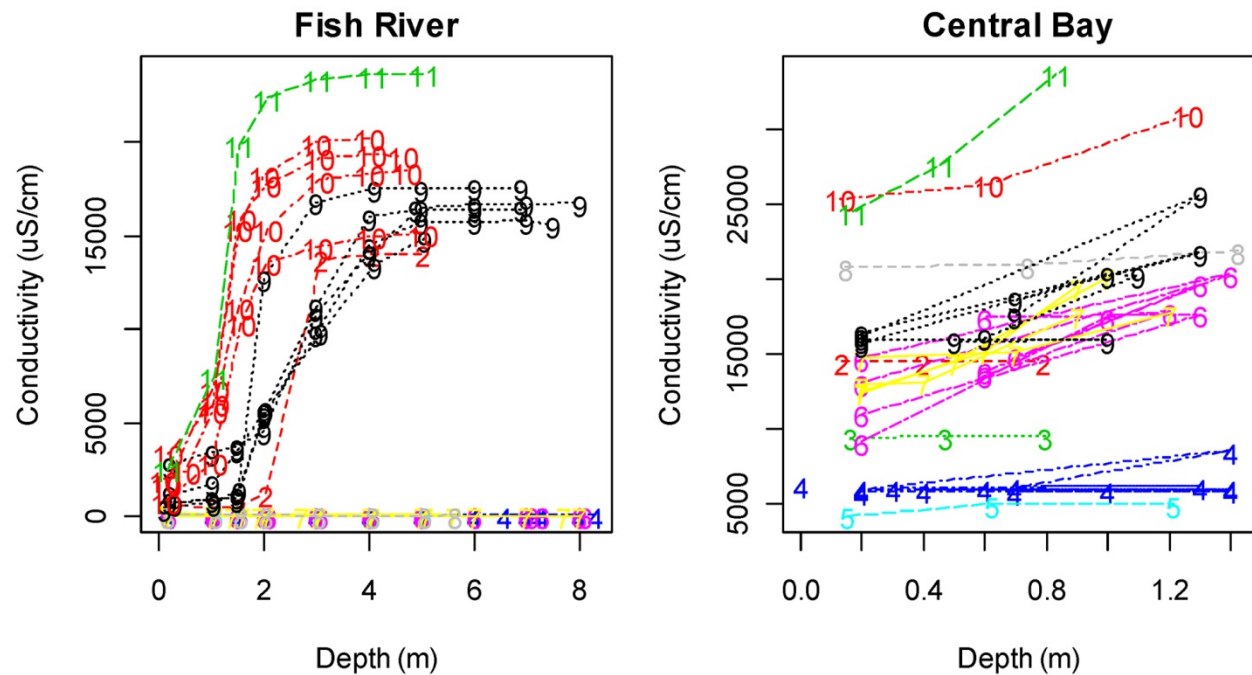

Note: The Fish River site is deepest of all locations.

**Figure 35. Conductivity fluctuations at different depths at a Fish River location (FSHB-7, left) and the center of mid-bay (WKBB-1, right graph).**

DO was also measured monthly at different depths in the mid-bay locations and tidal streams. The difference between the regular monitoring and the sonde reading is that the regular monitoring was mostly diurnal when DO was not close to the lowest point of the day (Figure 36). As a result, surface DO values (less than 1 meter) for all sampling locations are above the 5 mg/L DO for coastal waters. The ADEM DO criterion is applied at mid-depth for waters less than 10 feet deep (approximately 3 meters) and at 5 feet (approximately 1.5 meters) for waters 10 feet or more in depth (2010a, b).

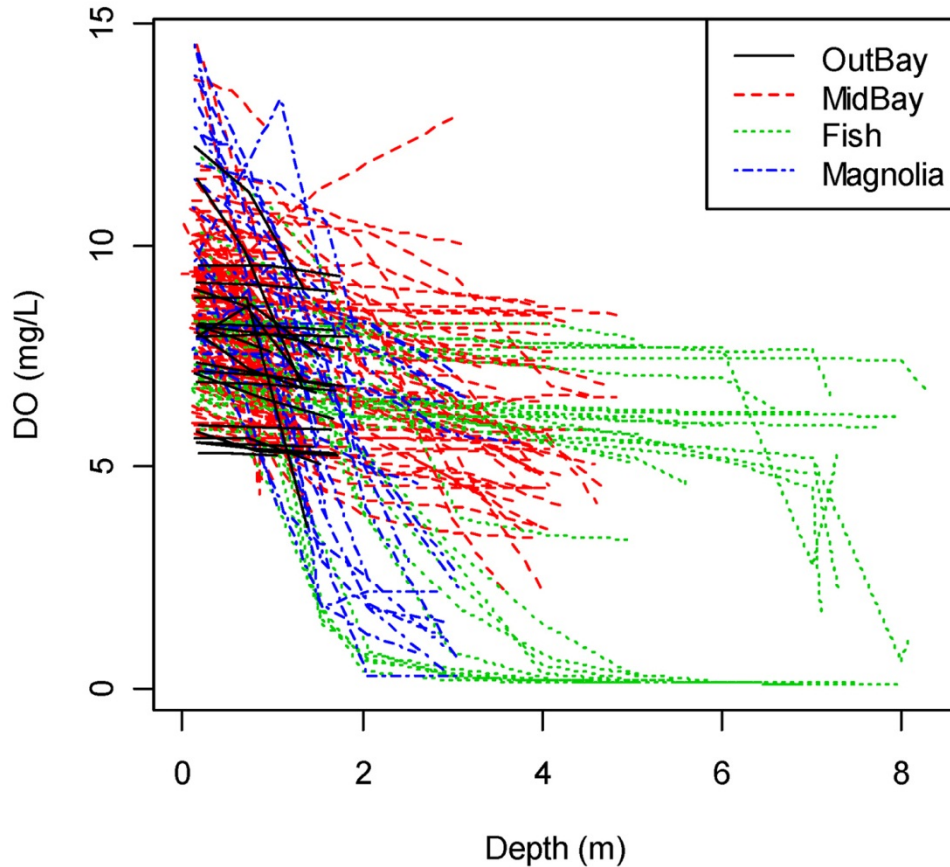

Note: One tidal station is also sampled in each of the Fish River and Magnolia River. The Fish River site is deepest of all locations, where the spring/summer data (March–August) are shown as flat lines and the fall data (September–November) as sharply declining with increasing depth.

Figure 36. DO trends at different depths by sampling locations.

## 7 Stressor-Response Relationships in the Mid-Bay

### 7.1 Correlations among Nutrient Parameters

A number of environmental variables follow a strong monthly pattern as shown earlier and here in the correlation plot (Figure 37). For example, both salinity and turbidity is strongly correlated with month ( $r = -0.74$  and  $-0.77$ ), two of the strongest correlation coefficients among all variables. Turbidity is an indicator of upwelling disturbance due to mixing between freshwater and seawater, which often varies strongly due to various flow regimes during dry/wet seasons (Brown et al. 2007) and during ebb and flood tides (Figure 16). Similar indicators, e.g., Secchi depth and TSS, also show strong seasonal patterns. In this study, the out-bay station in Mobile Bay has higher turbidity values than those in the mid-bay stations. The highest median values for TSS and TOC are for the Mobile Bay station, where strong mixing disturbance occurs (Figure 2, Figure 10).

Other more noticeable correlations are between TP and turbidity ( $r = 0.64$ ), and TN and Chl *a* ( $r = 0.57$ ). No relationship between Chl *a* and turbidity has been observed, indicating increasing cloudiness in the mid-bay is not a direct result of increasing sestonic algal biomass. Instead, rising TSS ( $r = 0.83$ ), along with sediment TP concentrations ( $r = 0.64$ ), could be the cause of decreasing light penetration (turbidity and Secchi depth). Another important nutrient response variable, DO concentration, however, is not strongly associated with any of the nutrient variables in this data set (not shown), though carbonaceous biochemical oxygen demand (CBOD) is strongly related with Chl *a* concentration in the bay ( $r = 0.59$ ).

Although all observed surface DO values over the past year were above the 5 mg/L DO criterion for coastal water of Alabama, they can drop rapidly with depth, especially in tidal streams (Figure 36). Stratifications mostly occur during the low-flow season (September–November) in the deep stations (e.g., Fish River). The Fish River station is well mixed during spring and summer when no sharp drop in DO was observed. The mid-bay stations are less likely stratified, but occasional DO disparity at different depths was observed.

## 7.2 Relationship between DO and Chl *a* in the Mid-Bay

The continuous monitoring effort provided by NERRS enables a detailed analysis of the relationship between water column DO concentrations and related environmental variables, including temperature, turbidity,  $\text{NO}_{2+3}$ , ammonia, and Chl *a* concentrations. Daily mean, minimum, and maximum DO values were recorded and related to Chl *a* and other variables. The strongest relationships were found between water column temperature and daily mean DO ( $R^2 = 0.51$ ), and between DO daily fluctuation and water column Chl *a* concentrations (Figure 38).

Because DO is less soluble in warmer water, it is not surprising to see a negative relationship between daily mean DO and temperature (O'Neil and Chandler 2003). The interesting relationship between DO daily fluctuation and Chl *a* is also consistent with our expectation that phytoplankton diel photosynthesis and respiration play a significant role in controlling DO concentrations in the water (Figure 38). Daily mean DO is only weakly correlated with salinity and turbidity ( $|r|$  less than 0.15). The probability of DO daily fluctuation greater than 5 mg/L increases significantly with rising Chl *a* in the water. Another interesting finding is that the daily mean DO concentrations do not increase or decrease with Chl *a*, which is not surprising because the increased fluctuation (more extreme values at both ends) of daily DO could have balanced the daily mean values.

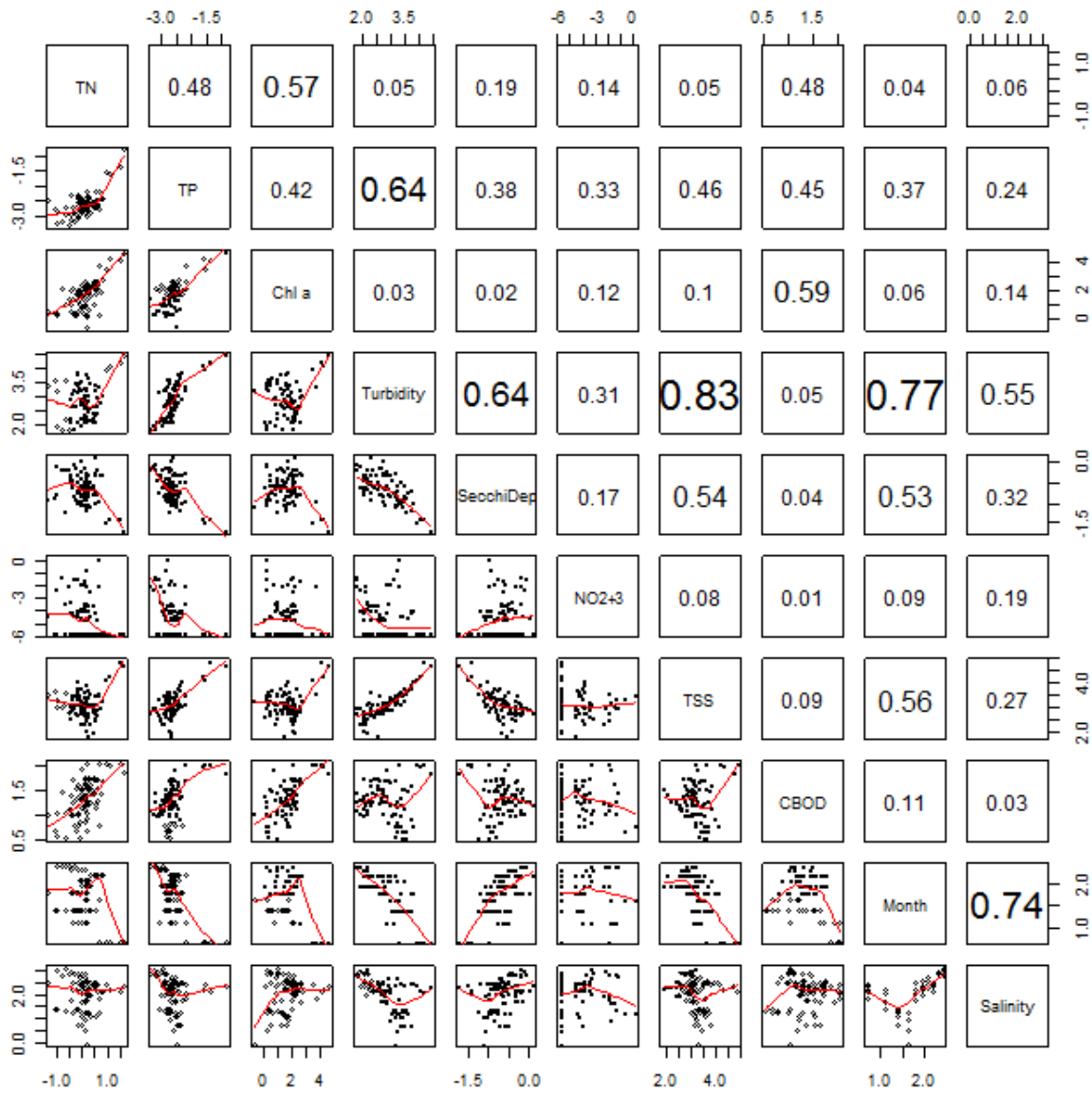

Note: All variables except DO have been log-transformed. The smooth lines are locally weighted smoothing lines (span = 2/3).

Figure 37. Spearman correlation coefficients among nutrient variables in the mid-bay data set.



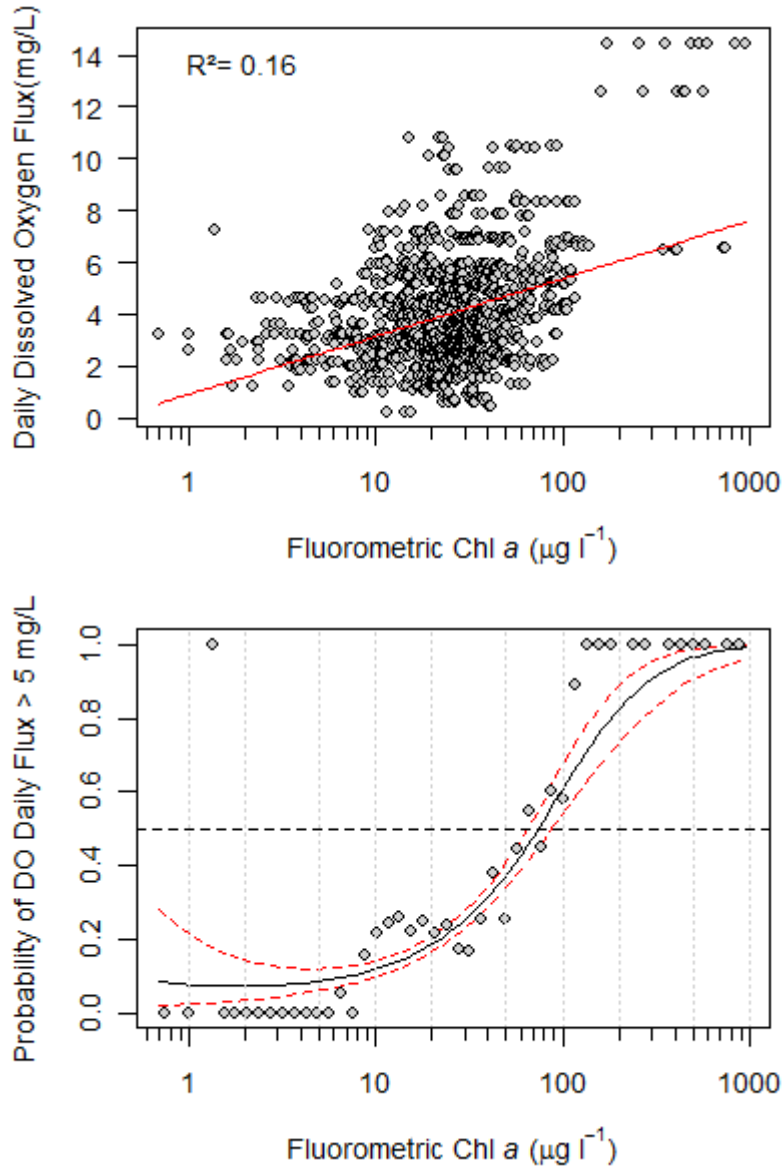

Figure 38. The relationship between DO daily fluctuation and Chl a concentration in the water column.

### 7.3 Relationships between Chl *a* and TN and TP Concentrations

Because water clarity (measured by turbidity, Secchi depth, and TSS) is heavily affected by suspended sediments from bottom upwelling in the bay (Figure 8, Figure 9, Figure 10), one way to quantify the impact of nutrients is to examine the relationship between Chl *a* and nutrient concentrations as expected by ADEM. The relationships between TP, TN, and Chl *a* concentrations are significant ( $p$  less than 0.01) but are mostly driven by several data points at the high ends of the gradients (Figure 39a, Figure 39c) when a nutrient spike occurred in February 2011. A multiple regression model including both TN and TP as predictors explains more variances ( $R^2 = 0.50$ , Figure 39e) than single predictor model ( $R^2 = 0.38$  Figure 39a for TP and 0.46 Figure 39c for TN, respectively), but only 4 percent increase from a TN model. Logistic regression analysis using a criterion for Chl *a* of 9  $\mu\text{g/L}$  shows a good fit between both TN and TP and the probabilities of exceeding the criterion. The multiple logistic regression model does not show a better fit than a simple TN model alone, indicating that TP might not be a strong limiting factor for Chl *a* concentration, or at least not as strong as TN.

Two problems arise when using this regression approach. First, the above regression analyses include all samples collected in an 11-month period at six stations, while most of the sampling points were collected in the low nutrient period (other than February). Pseudoreplications during spring and neap tide sampling period make the design extremely unbalanced. The unbalanced pseudoreplications could seriously bias relationships observed using all samples.

Another problem is that by using multiple regression analysis to set nutrient criteria, we must assume a relationship between TN and TP and ignore the variability around the relationship. Because the correlation between TN and TP is not very strong ( $r = 0.47$ , Figure 37), the assumed mean relationship between TN and TP might have a lot of noise.

#### Hierarchical Modeling

The wide range of spatial and temporal variation in nutrient concentrations might play an important role in shaping stressor-response relationships. To avoid the pseudoreplication problem pointed out above, we built a hierarchical multilevel modeling approach. This model takes into account both temporal (month) and spatial (station) variability in improving the model fit.

The total variances of TP were estimated using the hierarchical model:

$$S_{\text{tot}}^2 = (S_{\text{sta}}^2 + S_{\text{mon}}^2 + S_{\text{int}}^2 + S_{\text{res}}^2)$$

Then, the 75<sup>th</sup> or 90<sup>th</sup> percentiles of the TP distribution could be computed from this approach.

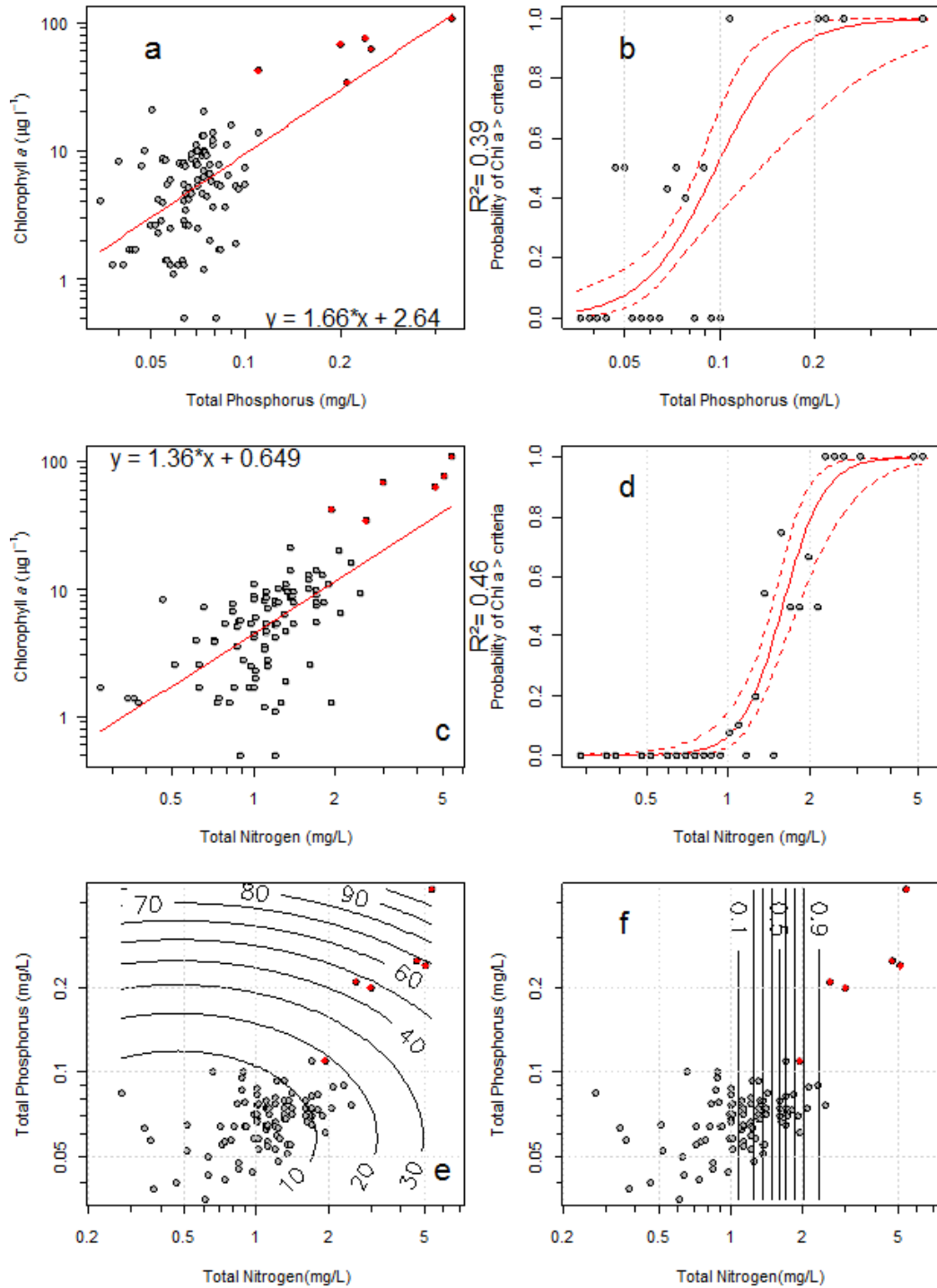

Note: Panels on the left show linear regression plots; the right column shows the logistic regression plots with probability of Chl *a* greater than 10 µg/L as the response variable. The top two rows are single nutrient models, and the third row is the regression models based on both TN and TP as predictors. Red dots are samples collected in February.

**Figure 39. Relationships between Chl *a* and TN and TP concentrations in Weeks Bay.**

A Bayesian hierarchical modeling approach for the mid-bay was also conducted to analyze stressor-response relationships. In this approach (Qian 2012), Chl *a* concentration is modeled as a conditional normal distribution of Chl *a* and functions of TN and TP, and fitted using the Markov Chain Monte Carlo (MCMC) simulation method (Plummer 2012). Month and stations are considered as random factors in the model. The MCMC output is processed in R using (mostly) the R package *rv* (Kerman and Gelman 2007).

When a multiple level model is fitted, the conditional distribution of model parameters can be used to make sure Chl *a* will not exceed certain level at an alpha level of 10 percent. Each fitted line in Figure 40 is the conditional TN and TP values below which Chl *a* concentration would be below a certain value.

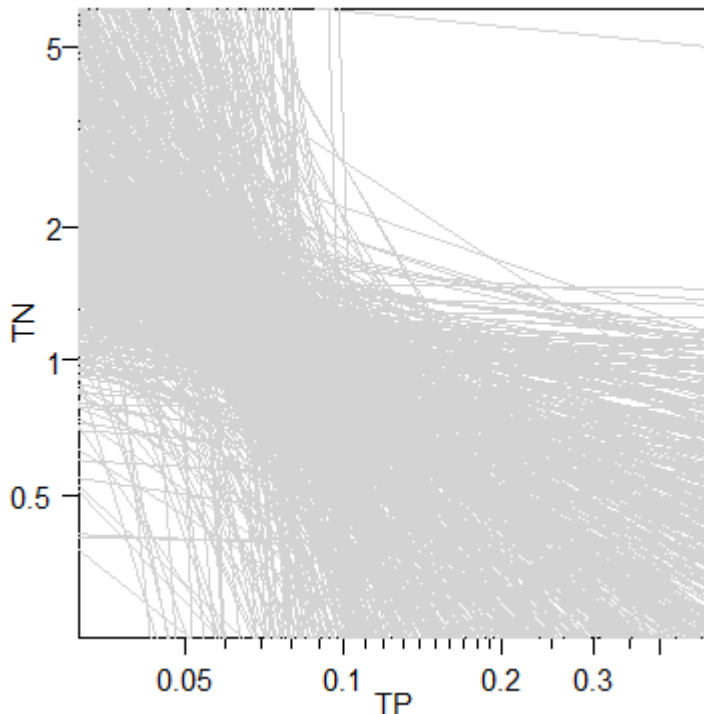

Note: 1,000 simulations were performed.

**Figure 40. Random fitted lines derived from TN and TP (mg/L) multilevel models using MCMC procedure.**

## 7.4 Biological Assessment of Benthic Condition in the Mid-Bay

### *Macroinvertebrate Composition and Environmental Gradients*

Macroinvertebrates were collected at six mid-bay locations in Weeks Bay to use in evaluating as the biological indicator of aquatic life uses. Methods used were consistent with those used by the National Coastal Assessments (NCA; Strobel and Heitmuller 2001), for both field sampling and laboratory processing, as follows: bottom grab samples were taken a Petite Ponar sampler, with two grabs composited to represent the site. Samples were washed on board the boat, preserved with formalin, labeled, and delivered to the laboratory for processing. Organisms were sorted under a maximum of 5x magnified ring lamp, and taxonomic identifications are to species level using standard counting guidelines. Quality control (QC) evaluation of the sorting was done in an independent laboratory and resulted in a

mean sorting efficiency of 97.6, with zero samples failing (substantially better than the project measurement quality objective of 90 percent). The QC for taxonomic identifications was done using independent re-identifications in a separate laboratory and resulted in an estimate of taxonomic precision (percent taxonomic disagreement [PTD]) of 3.6 percent (Attachment). Both data quality/performance measures indicated suitability for additional analyses.

The most dominant taxa in the mid-bay are bivalves and worms (greater than 90 percent). Capitellidae, Spionidae, and Mysidae are families frequently found in the samples. *Mediomastus*, *Streblospio*, *Capitella* and *Americamysis* are the most common genera, many of which are considered tolerant taxa.

Biological condition in most parts of the mid-bay, based on the Benthic Index of Biological Integrity (BIBI) (Tetra Tech 2011b) is non-degraded, or healthy. BIBI scores are lowest in the Fish River location just upstream of the bay (WB-1) (Table 4), followed by locations outside the mouths of Fish River (WKBB-5) and Magnolia River (WKBB-4). The two stations near the mouth of Fish River are considered impaired (BIBI less than 55) if judged by the 10<sup>th</sup> percentile draft impairment threshold (Tetra Tech 2011b), with more than 75 percent tolerant taxa found in these locations. The rest of the stations within the mid-bay have only 30–40 percent tolerant macroinvertebrate individuals and index scores in the 60s, which are above the same impairment threshold.

**Table 4. BIBI scores at six sampling locations**

Station ID	BIBI	% tolerant taxa	Impairment status
WB-1	43.7	93.2%	Impaired
WKBB-5	48.7	76.0%	Impaired
WKBB-4	61.1	42.6%	Non-Impaired
WKBB-1	65.3	30.0%	Non-Impaired
WKBB-6	65.8	40.5%	Non-Impaired
WKBB-2	68.0	39.2%	Non-Impaired

The BIBI is strongly associated with several environmental variables including salinity, TSS, CBOD, Chl *a* concentrations, and TN (Table 5). The annual geometric mean values of these environmental variables represent the central tendency of environmental conditions for the sample year 2011. Although the causation of biological impairment in this study is not clear, the strong associations between BIBI and TN and Chl *a* concentrations suggest that the biological impairment of the stations near Fish River could be caused by heavy nitrogen input, algal blooms (high Chl *a*), and associated high chemical-biological consumption and oxygen depletions in the benthic habitat. Because of strong diel and seasonal fluctuation of DO, it is often difficult to link macroinvertebrate conditions with sparse measurements of DO in this data set. The low DO condition frequently occurred in the Fish River station (Figure 25), and impaired biological condition and relatively better DO and biological conditions in other parts of the bay indicated low DO stress could be the cause of biological degradation at the mouth of Fish River.

One interesting association is the strong positive correlation between BIBI and TSS ( $r = 0.89$ ). That is, rising TSS could benefit benthic invertebrate community in the mid-bay. As discussed earlier, TSS is an indicator of upwelling disturbance in the mid-bay, rather than rising sestonic algal bloom and DO concentrations. The strong association could be due to the reduced nutrient enrichment (diluted nutrient concentrations) and algal biomass in the mixing zone in the mid-bay. Similarly, rising salinity in the mid-bay also indicates diluted upstream pollution and does not necessarily reflect a causal factor for BIBI increasing in the mid-bay locations.

**Table 5. Spearman correlations between BIBI scores and environmental variables**

Variables	Correlation coefficient
Total P	-0.31
Total N	-0.71
Total Kjeldahl nitrogen (TKN)	-0.71
NO <sub>2</sub> + NO <sub>3</sub>	-0.6
Chl <i>a</i>	<b>-0.89</b>
Turbidity	0.49
Secchi depth (m)	-0.54
CBOD	-0.54
Total organic carbon	-0.54
Dissolved organic carbon	-0.60
DO	-0.37
Salinity	<b>1</b>
Conductivity	<b>1</b>
pH	-0.09
Total suspended solids	<b>0.89</b>

### *Observed Relationship between Chl *a* and BIBI*

The direct effect on benthic community that leads to low BIBI scores could be oxygen depletion (Figure 41). Hypoxia is caused by rising nutrient and organic enrichment, increasing sestonic algal production, and CBOD. This study found that rising Chl *a* concentrations are strongly associated with CBOD in the mid-bay ( $r = 0.59$ , Figure 37), which also leads to oxygen depletion, especially in the evenings. Both summer mean and annual mean Chl *a* were found strongly associated with BIBI in this study (Figure 41).

## 8 Proposed Nutrient Criteria for Mid-Bay Locations

### 8.1 DO Criterion

The effects of low DO on the biological community might not occur rapidly, so it is not surprising that stations with extreme low surface DO condition are still hosting a relatively healthy biological community, such as most of our observations in this Weeks Bay study. The mean daily minimum of DO values over the 5 years (2007 through 2011) are lowest at Fish River Station (5.0 mg/L) but highest near the outlet of the bay (6.1 mg/L) (Figure 25). In the year before the biological sampling (07/01/2010–08/08/2011), the mean daily minimum DO values are lower than the 5-year average, especially at the Fish River station. The frequencies of extremely low DO values (daily minima less than 2, 3, 4, and 5 mg/L) were also highest at the Fish River station and lowest near the outlet of the bay (close to WKBB-2).

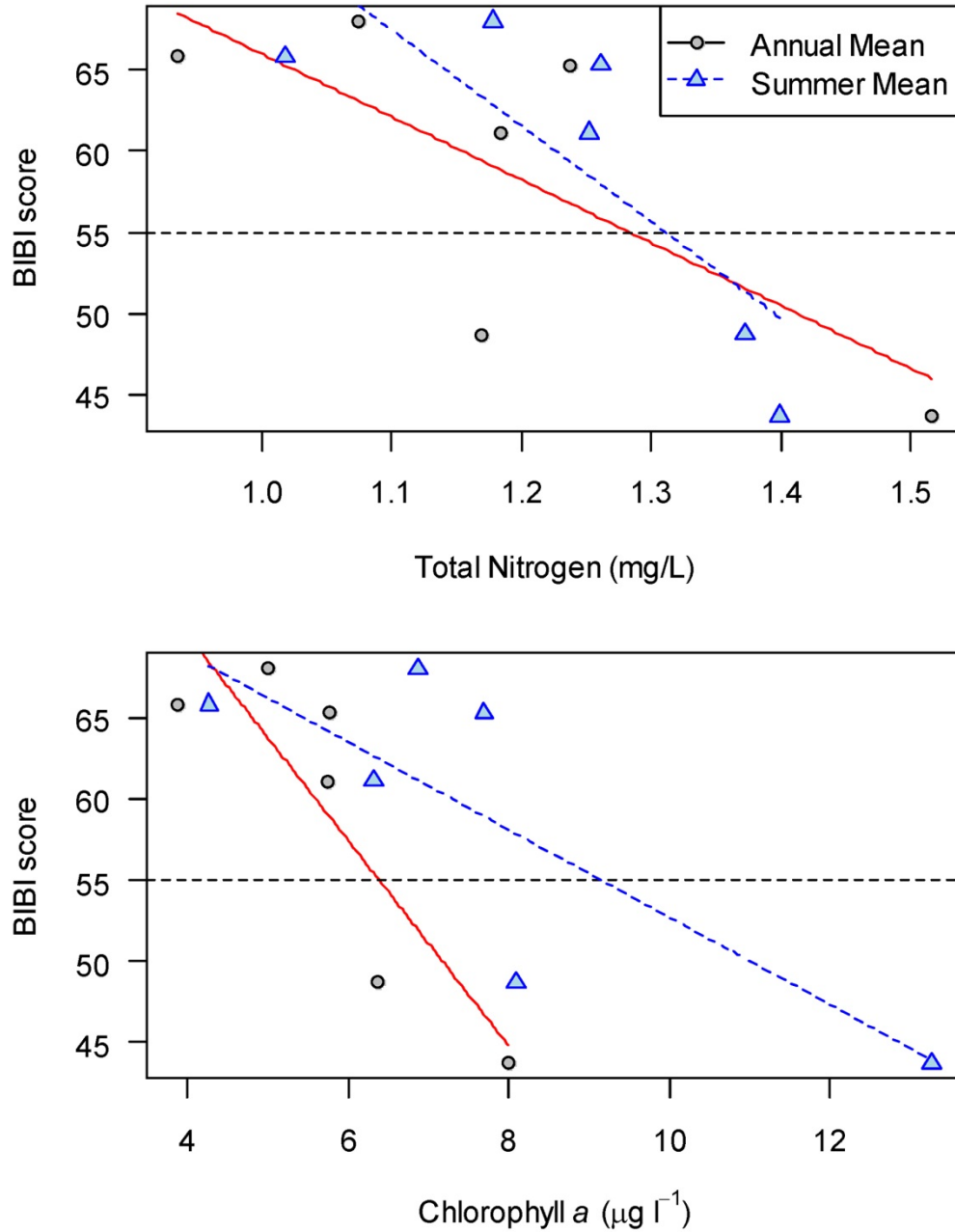

Note: All variables have been log-transformed. The smooth lines are locally weighted smoothing line (span = 2/3).

**Figure 41. Regression Analyses between annual mean and summer (June–October) mean values of environmental variables and macroinvertebrate BIBI in the mid-bay stations.**

Between July 2010 and August 2011 at the Fish River station, 38.3 percent of the daily minimum DO values are below 3 mg/L and 64.6 percent below 5 mg/L (Table 6), about 12 percent higher than the 5-year average. Only about 25 percent of the daily minimum DO values are less than 3 mg/L and about 40 percent less than 5 mg/L for the rest of the bay, which are 20 percent less than the impaired site. Apparently, these long-term hypoxic conditions could have contributed to the range of benthic biological conditions in the bay.

**Table 6. Summary of daily DO minima and frequencies when daily DO minima are less than 2, 3, and 4 mg/L in NERRS data set.**

Period	Min. DO	Fish River nr. WK-1		Center Bay nr. WKBB-1		Magnolia River nr. WKBB-4		Bay outlet nr. WKBB-2	
		A	B	A	B	A	B	A	B
Mean daily minimum		5	4.3	5.4	5.5	5.3	5	6.1	5.8
Mean daily fluctuation		3.6	3.6	4.4	4.3	4.2	4.6	3.3	3.4
Percent of days	< 2 (mg/L)	14.3%	22.0%	14.0%	17.4%	11.9%	14.8%	5.8%	10.7%
Percent of days	< 3 (mg/L)	26.1%	38.3%	21.7%	33.8%	20.7%	24.5%	10.5%	16.2%
Percent of days	< 4 (mg/L)	37.7%	52.5%	32.7%	34.1%	31.6%	31.0%	19.6%	19.1%
Percent of days	< 5 (mg/L)	51.7%	64.6%	43.4%	42.1%	44.2%	40.1%	33.0%	32.9%

Note: The total numbers of days are 1,690 and 412 days, respectively; period A - 01/02/2007–08/18/2011 (n=1,690 days), period B - 07/02/2010–08/18/2011 (n=412 days).

As pointed out earlier (page A-47), DO was strongly associated with water column temperature. The relationship is observed in both biological impaired site and non-impaired sites (Figure 42). The probabilities of daily minimum DO less than 5 mg/L are most likely to occur in higher water temperature (greater than 20 °C), and more likely in the biologically impaired site (WB-1). The differences in probabilities could be around 20 to 25 percent as shown in Table 6 and Figure 42.



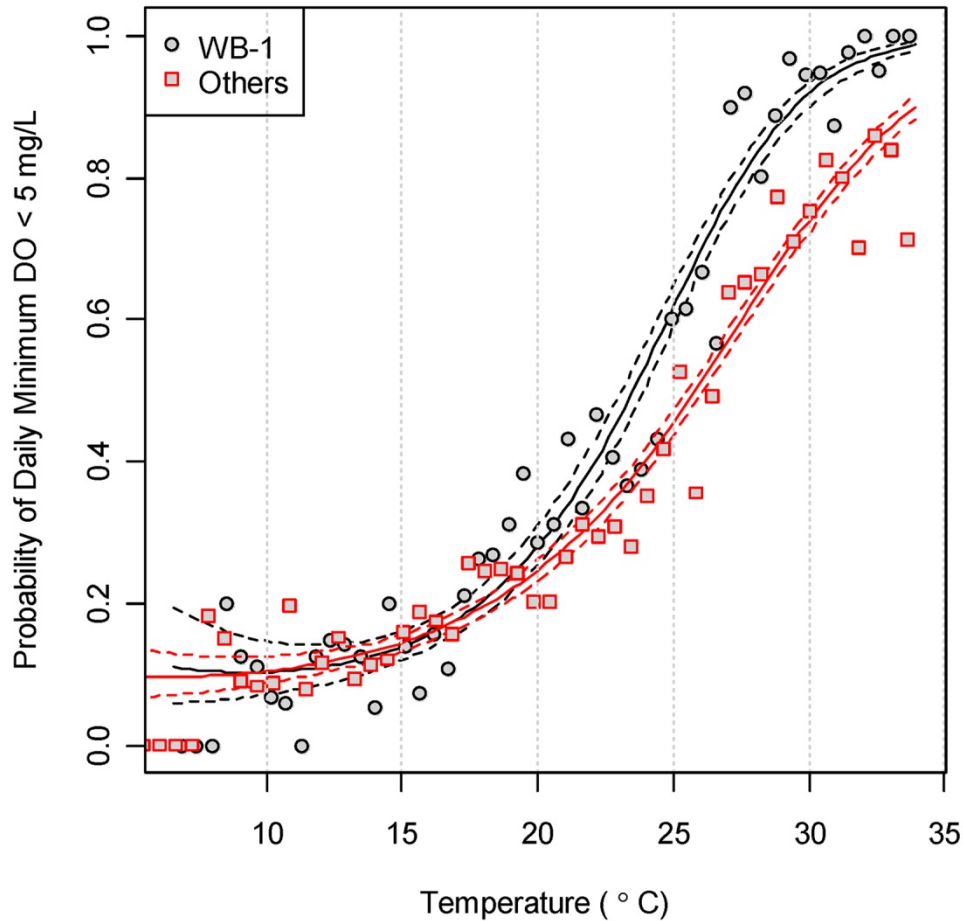

Note: The dots are the mean probabilities in each equally distanced bin.

**Figure 42. The logistic regression model fits and their 90 percent confidence intervals between daily minimum DO and daily mean water temperature at the Fish River station (near WK-1, black lines) and other three stations in the Weeks Bay (NERRS/CDMO).**

The Fish River station (WK-1) was determined as biologically degraded and could be caused by low DO. The differences in frequencies of low DO events between this station and other stations in the bay could be used to discriminate biological degradation versus non-degradation (Figure 43). When the daily DO minimum is set to be less than 5 mg/L, the mean differences of extreme DO event frequencies between Fish River station and other mid-bay stations are the largest, indicating the highest risk of biological impairment and least risk in other stations. In addition, the Fish River station is much deeper than other mid-bay stations, so hypoxia conditions at this station could be much more persistent than the surface water.

If the daily minimum DO criterion is set to 5 mg/L (magnitude) according to the current regulatory requirement, the acceptable frequency of exceeding this criterion should also be set. The mean exceeding frequency of daily DO minimum in non-degraded sites is less than 45 percent, and the mean exceeding frequency at degraded sites in the past year is about 65 percent, and in the past 5 years, 52 percent. Therefore, the acceptable exceedance frequency for Weeks Bay should be less than or equal to 50 percent when daily mean temperature is above 20 °C.

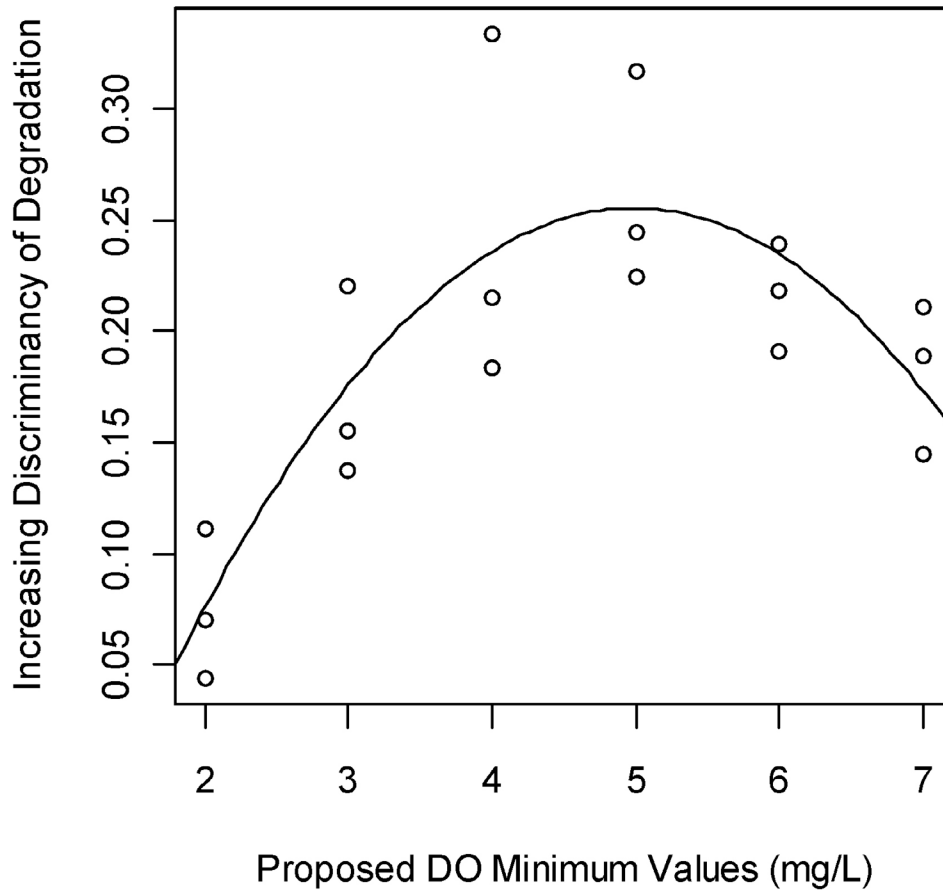

Figure 43. The relationship between selected minimum DO values and discrimination of biological degradation.

## 8.2 Chl *a* Criterion

A quantitative Chl *a* criterion can be established using the relationship between BIBI versus spectrophotometric Chl *a* as observed in Figure 41. According to the regression model, if BIBI is equal to 55 and is set to be the goal of protection, the annual geometric mean Chl *a* concentration based on spectrophotometric method should not exceed 6.4  $\mu\text{g/L}$ , and the summer geometric mean Chl *a* should not exceed 9.1  $\mu\text{g/L}$ . However, these values are derived from limited data (only 6 data points), and the confidence for the criteria are low.

Although Chl *a* criteria have not been determined for estuaries in Alabama, criteria for lakes usually are set around 10–20  $\mu\text{g/L}$  Chl *a* to protect lakes from excessive algal biomass. The proposed spectrophotometric Chl *a* criteria should be set to an annual geometric mean of 6.4 or a summer geometric mean of 9.1  $\mu\text{g/L}$ . Bricker et al. (2003) defined medium trophic level of Chl *a* concentrations is between 5 and 20  $\mu\text{g/L}$  in the estuary. Hagy et al. (2008) recommend summer median concentrations less than 8  $\mu\text{g/L}$  Chl *a* criterion for Pensacola Bay, Florida, which is fairly consistent with our results.

Although harmful algal blooms (i.e., elevated Chl *a* level) could affect biological condition, it is primarily a result of oxygen depletion in the bay. Both daily minimum and maximum DO are significantly correlated with fluorometric Chl *a* in the water column, but the regression coefficients are relatively small ( $R^2$  less than 0.05). That is, Chl *a* can account for only a small amount of variation in DO depletion. Many other factors, e.g., water temperature (accounts for greater than 50 percent [see page A-33]), flow regime, bacterial activity, sediment upwelling, could have affected DO concentrations in the water columns. However, the relative risk of daily minimum DO less than 5 mg/L increases dramatically with increasing water column Chl *a* (Figure 44). When fluorometric Chl *a* concentrations reach 25  $\mu\text{g/L}$ , the probability of daily minimum DO less than 5 mg/L increases to above 50 percent.

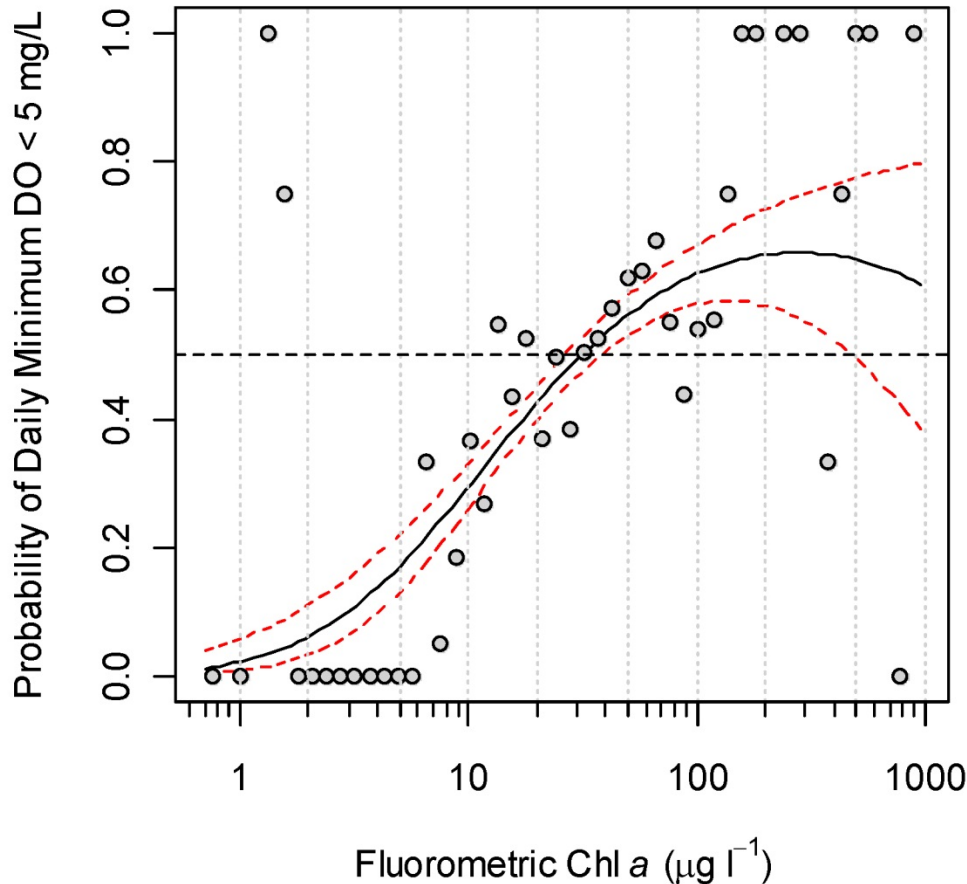

Note: The fitted lines are the logistic regression fit with 90 percent confidence intervals. The dots are the mean probabilities in each equally distanced bin.

**Figure 44. The relative risk of daily minimum DO < 5 mg/L with increasing Chl *a* concentrations.**

The spectrophotometric method (used by ADEM in this study) and fluorometric method (used by EPA 2011 and NERRS long-term monitoring, 2008) for measuring Chl *a* concentrations in the water column cannot be converted between each other easily (Figure 45). Both methods have their pros and cons (Pinckney et al. 1994) and have been recommended by EPA and adopted by many states as standard methods for Chl *a* determination.

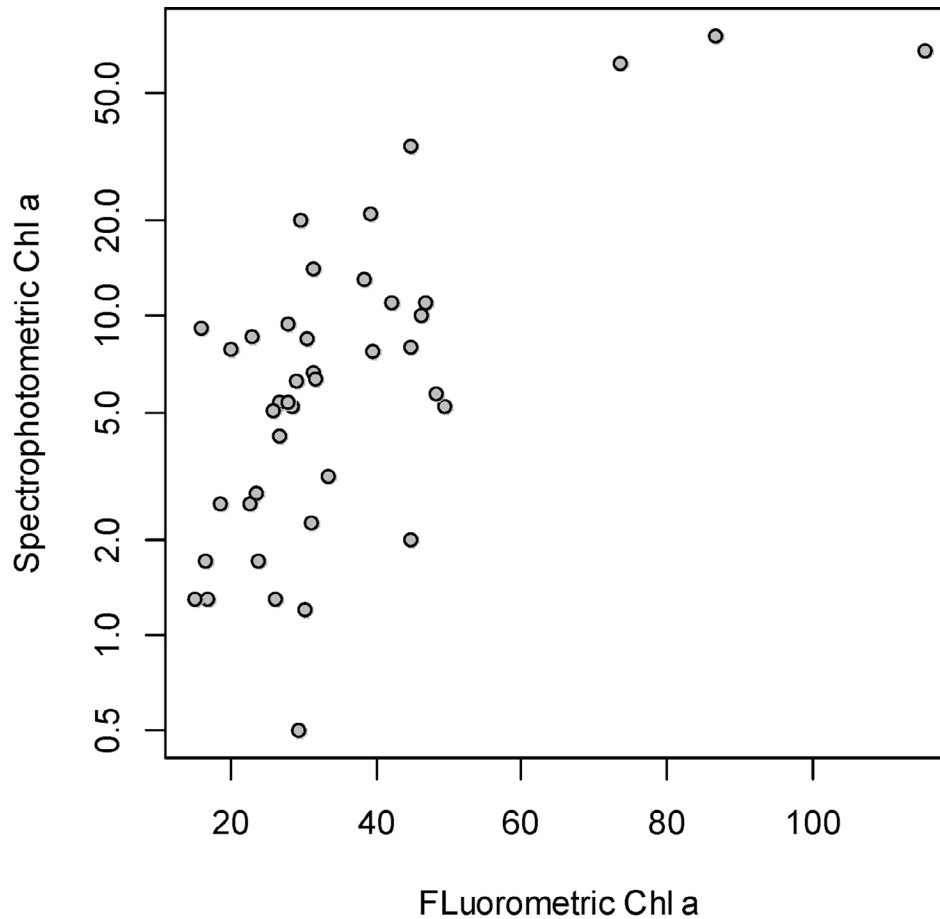

Note: Samples may not have been collected on the same dates.

**Figure 45. Relationship between fluorometric and spectrophotometric methods based on monthly mean Chl *a* measurement at same locations.**

### 8.3 TN and TP Criteria

#### Reference Approach

One way to set nutrient criteria, especially for TP in this data set, is to use a reference approach on the basis of certain percentile of background TP in the bay where it is determined as non-degraded (USEPA 2001). Because TP concentrations are only weakly associated with Chl *a* concentrations in the bay, further investigation is needed to determine the causative factors of increasing algal biomass in the bay. At the same time, one of the rivers (Fish River) is still discharging a significant amount of TP. To protect the current status of the bay, a TP criterion could be set stating that TP should not exceed the current level using a reference condition approach. The reference condition approach usually selects a certain percentile of current levels (75 or 90 percent) on the basis of available data in the mid-bay, which is already higher than the Magnolia River, but probably is lower than the Fish River stations. In this data set, the 75<sup>th</sup> percentile is 0.077 mg/L TP, and the 90<sup>th</sup> is 0.093 mg/L TP in the four mid-bay stations. The 75<sup>th</sup> and 90<sup>th</sup> percentiles for NO<sub>2+3</sub>-N concentrations are 0.2 and 0.97 mg/L, respectively, while the 75<sup>th</sup> and 90<sup>th</sup> percentiles for TN concentrations are 1.4 and 1.7 mg/L, respectively.

## Regression Models

The significant relationships between TP, TN, and Chl *a* concentrations indicate that excessive nutrient loading into the bay might lead to elevated Chl *a* concentrations. The regression models developed in the previous chapter (Figure 39) could be used to develop nutrient criteria to protect the bay from algal blooms. If the Chl *a* criterion is set at 9 µg/L, according to simple regression models for TN and TP (Figure 39a, c), the fitted lines would intercept with TN at 1.7 mg/L and TP 0.1 mg/L. According to the simple logistic regression models (Figure 39b, d), the 50 percent probability of exceeding Chl *a* criterion of 9 µg/L would occur at TP around 0.1 mg/L and TN around 1.57 mg/L. The multiple regression model is more complicated because we have to either fix one parameter to predict the other, or assume a constant relationship between TN and TP. In the multiple regression model (Figure 39e), when the mean relationship between TN and TP is assumed, the expected TN and TP would be 1.4 and 0.08 mg/L, respectively. For the multiple logistic regression model (Figure 39f) at 50 percent probability, TN and TP criterion are 1.57 and 0.09 mg/L, respectively.

When a Bayesian multiple level model is fitted (Figure 40), the conditional distribution of the model can be used to derive TP, TN criteria to ensure a Chl *a* criterion of 9 µg/L will not be exceeded at an alpha level of 10 percent. Each fitted line in Figure 40 is the conditional TN and TP values below which Chl *a* concentration would be below 9 µg/L. Because TN and TP criteria cannot be set simultaneously, one variable must be fixed (e.g., fix TP criterion at 0.1 mg/L) to derive the other. If we consider that TP is not the limiting factor in this bay as in most marine systems (Hecky and Kilham 1988), we can fix it at a realistic level and try to derive the other one (TN) from the equation (line). The maximum allowable TN would be around 1.2 mg/L (90<sup>th</sup> percentile) to ensure Chl *a* below 9 µg/L 90 percent of the time.

## 9 Summary

The monitoring study in 2011 shows strong heterogeneity in the Weeks Bay system, both spatially and temporally. Spatially, the Weeks Bay system represents transitional characteristics from freshwater wadeable streams to marine system. Upstream areas of the Weeks Bay system contain typical black water streams with low pH and planktonic productivity, though nutrient loadings from the two streams are very different, with high TP and TN loadings from one stream (Fish River mainstem) but low TP and high TN loadings from the other (Magnolia River). The tidal streams are heavily mixed by water inflow from both freshwater and marine water. The water becomes circumneutral pH and salty. Water clarity dramatically decreased while sediment-related parameters (turbidity, TSS and Chl *a* concentration) all rise magnitudes higher than upstream. DO starts to show diurnal variation with increased influence of planktonic productivity. High TN and TP concentrations in the Fish River have been diluted by marine water in the tidal river, while the upper Magnolia River TN concentrations are diluted by the marine water in the tidal portion, increasing TP concentrations in the Magnolia tidal river are mostly received from marine sources. The Weeks Bay stations have higher salinity, turbidity, TP, and TSS than the tidal streams; but within bay variations are much lower in comparison to high temporal variability in the bay.

The distinct characteristics among different water bodies also vary strongly at temporal scale. Nitrogen levels in wadeable streams are relatively constant while TP tend to vary more in different months. Nutrient concentrations (especially TN) and Chl *a* in non-wadeable tidal streams and the mid-bay tend to follow a similar temporal variation pattern: peak in the early spring and later in the fall. These variations are also affected by tidal events to some extent daily—the mid-bay stations tend to have lower TP and turbidity and higher TN during ebb tides than during flood tides. Available data indicate that increasing turbidity or decreasing Secchi depth in the mid-bay is not directly related to increasing algal biomass in the water column. Instead, it shows strong daily and monthly variation and seasonal pattern, with highest

turbidity during flood tide, at the beginning of the year and decreasing to the lowest level at the end of the year. Similarly, TN and TP also peak in one of the early spring events then suddenly drop to the lowest level in the spring and increase eventually to a higher level in the fall in the dry season. Available data suggest that changes of wind speed and direction, storm events, and tides have a great effect on water clarity in the mid-bay. Increasing phytoplankton biomass could be due to rising nitrogen concentrations from upstream inputs. However, only limited evidence from this study could link phosphorus import from upstream in the Fish River to the cause of algal bloom in the mid-bay.

Long-term monitoring data (NERRS) in the mid-bay reveals similar spatial and temporal patterns as observed in the 2011 study. Salinity fluctuates 14–15 ppt seasonally at the four sampling stations and fluctuates 6–16 ppt at different times from 2007 to 2011. The highest salinity is later in the fall during dry season (September–October), whereas the lowest salinity is in the spring wet season (March–May). DO mean diurnal fluctuation in the surface water is 3.5 mg/L, with 90 percent of the fluctuations between 0.9–7.8 mg/L. Daily minimum DO could approach 0 mg/L, especially in summer months (July–August) but is highest in winter months (November–January). Overall, the mean daily minimum DO was lowest at the Fish River station (5.0 mg/L) but higher near the outlet of Weeks Bay (6.1 mg/L). Turbidity in the bay shows a weaker seasonal pattern than salinity and DO. Turbidity is higher in spring through summer and drops to lower level in the late fall and winter. Chl *a* concentrations vary annually, and only a weak peak was observed in the late spring, then a drop in the summer, followed by a bloom in late fall. Chl *a* concentrations at the Fish River station have increased since 2003 to around 30–40 µg/L in recent years. NO<sub>2+3</sub>-N concentrations are highest at the Fish River and Magnolia River mouths than the rest of the bay, whereas the seasonal components show higher concentrations in the fall to winter months than in the spring. Similarly, NH<sub>4</sub>-N is also higher at the Fish River station in the past 10 years but shows obvious seasonal patterns.

In this study, several nutrient parameters, e.g., TN, NO<sub>2+3</sub>, NH<sub>3</sub>, have similar ranges to those observed in previous studies conducted from 1994 to 1997 (O’Neil and Chandler 2003), but TP concentrations are significantly higher (*p* less than 0.05) at station WB-1 (median greater than 1 mg/L) than historical TP range (0.01–0.1 mg/L). Upstream wastewater treatment plants and rapid urbanization in Fish River watershed might have contributed to the rising TP concentrations. Another significant finding is that sediment related parameters, e.g., TSS and turbidity, have decreased over the past 15 years or so at all stations, indicating reduced sediment loadings from upstream watersheds.

Benthic biological condition in the mid-bay is mostly healthy, except at locations near the Fish River inflow. BIBI scores are below the degradation threshold of 55 at these two stations, while other parts of mid-bay have relatively high BIBI scores. The low BIBI scores are potentially caused by high nutrient input, resulting in elevated algal blooms and depleted oxygen concentrations, especially in the lower Fish River.

The impact of DO depletion on benthic biological conditions may not occur rapidly. Almost all stations in the mid-bay have low DO conditions during certain times in the past five years (2007–2011). Although the mean daily minimum DO at the Fish River station (5.0 mg/L) is only slightly lower than other stations, the frequency of low DO conditions (64.6 percent; daily minimum DO less than 5 mg/L) is greater than 25 percent higher than the rest of the mid-bay in the year prior to the biological sample collections. Long-term hypoxic conditions could have contributed to the observed differences in biological conditions across Weeks Bay. Therefore, to protect benthic biological conditions, the frequency of daily minimum DO concentration less than 5 mg/L should never exceed 50 percent of time.

Both fluorometric and spectrophotometric Chl *a* concentrations have been measured in Weeks Bay studies (those data from the NERRS/CDMO and the present study, respectively). The long-term Chl *a* monitoring (using fluorometric method) in the NERRS clearly demonstrated that rising Chl *a*

concentrations most strongly contributed to DO fluctuations, but they are less strongly associated with daily DO minimum and maximum. When Chl *a* concentration exceeds 25 µg/L, the probability of daily DO minimum less than 5 mg/L rises to more than 50 percent. Our study relates spectrophotometric Chl *a* to BIBI score. When the BIBI criterion is set to 55, the potential criterion for spectrophotometric Chl *a* is 6.4 or 9 µg/L, annual and summer geometric mean, respectively.

Regression analyses reveal that both nitrogen and phosphorus are associated with spectrophotometric Chl *a* concentrations in the bay, but TN is a better predictor than TP. The criteria for TP can be either developed from a reference approach on the basis of current condition in the mid-bay to prevent increasing TP loadings into the bay from Fish River, or from the multiple regression analysis when mean relationship between TN and TP is assumed. To protect the current status of the bay, we can set a TP criterion that *should not exceed* the current level using a reference condition approach. The reference condition approach usually leads to selecting a certain percentile of current levels (75 or 90 percent) according to available data in the mid-bay, which is already higher than the Magnolia River but probably lower than the Fish River. Then, the 75<sup>th</sup> or 90<sup>th</sup> percentiles of the TP distribution are computed around 0.086 and 0.1 mg/L. In the multiple regression model (Figure 39e), when the mean relationship between TN and TP is assumed and the Chl *a* criterion is set to 9 µg/L, the expected TN and TP would be 1.5 and 0.09 mg/L, respectively.

## 10 Recommendations

The monitoring performed over the past year provided a rich data set enabling a better understanding of spatial and temporal variations of nutrient concentrations and inflow/outflow to and from the Weeks Bay system. However, the data set represents only one year, which, based on the spatial and temporal complexity of the watershed, provides only a beginning to understanding inter-annual consistency. The observed stressor-response relationship in the current data set represents only a limited linkage between TN and elevated Chl *a* concentrations in the bay. More extensive data collections are needed to better understand the dynamics of nutrient spikes in Weeks Bay. On the basis of current results, we recommend the following:

1. To protect benthic biological conditions (aquatic life use), the daily minimum DO concentration should be less than 5 mg/L, 50 percent of the time in summer when daily mean temperature is above 20 °C.
2. When fluorometric Chl *a* concentrations reach 25 µg/L (grab sample), the probability of daily minimum DO less than 5 mg/L increases to above 50 percent. Therefore, to control the magnitude and frequency of hypoxia stress on aquatic life, a criterion of 25 µg/L *fluorometric* Chl *a* is recommended.
3. According to the limited data (as noted) over the past year, and to control the magnitude and frequency of hypoxia stress on aquatic life, a tentative/preliminary criterion for *spectrophotometric* Chl *a* could be established at annual geometric mean Chl *a* less than 6.4 µg/L and summer geometric mean Chl *a* less than 9.1 µg/L.
4. The recommended nutrient criteria are TP less than 0.09 mg/L and TN less than 1.5 mg/L; however, these values should be updated following subsequent data collections in the Weeks Bay system and analyses relating them to those of other Gulf of Mexico estuaries.

The sampling design behind this data set provided a clear picture of nutrient and other water quality characteristics in the Weeks Bay watershed. We recommend using results of this study to inform

future/longer-term monitoring designs for Weeks Bay and for other Gulf of Mexico inland estuaries. Suggestions are the following:

- a. *Incorporate with existing NERRS study.* The existing long-term monitoring effort by NERRS offers an excellent opportunity for analyzing long-term dynamics of DO, salinity, and other environmental variables in the Weeks Bay system. Future monitoring should use existing data and provide complementary effort to better characterize nutrient conditions in the bay. One of the best uses of the NERRS data set is to provide comparable Chl *a* measurements at similar or same locations. Also, future monitoring should provide additional variable monitoring that NERRS does not offer currently, e.g., TKN, TP, TOC, or CBOD.
- b. *Conduct multiple year study.* The pattern shown from current analysis indicated that temporal variability is far greater than spatial (within bay) variability. Longer-term monitoring is needed to better capture that variability across the range of environmental gradients. Although NERRS data provided valuable information on long-term variability, the incomparability of the data with current monitoring efforts makes it difficult to confirm the pattern observed from this study. At least 3 years of monitoring are needed to provide better confidence in statistical assumptions.
- c. *Increase the frequency of biological monitoring.* This study judges biological condition at locations on the basis of a single benthic sample. Because of the small size of Weeks Bay, it would be useful and informative to take future benthic samples from at least the four stations where NERRS monitoring is conducting continuous monitoring. This would target those sites for annual sampling over multiple years and would contribute to better understanding the nature and effects of nutrient input from the two principal freshwater inflows, and from Mobile Bay proper.
- d. *Reduce the scale of monitoring effort.* Freshwater streams had relatively constant water quality conditions observed during the year (2011), and thus, the measurement/sampling frequency for many of the parameters could be reduced to help save budgetary resources. Also, instead of three sites on the Fish River, sufficient data would be produced from one site placed on the mainstem, upstream of tidal influence and downstream of the confluence of the tributaries, preserving additional resources. For water chemistry and Chl *a*, future sampling could be done, and would be sufficient at upper wadeable streams (two sites), tidal streams (two sites), mid-bay (five sites) and one in Mobile Bay itself (eight sites total).
- e. *Reduce sampling events.* Several sampling events could be dropped if future monitoring is conducted. Episodic nutrient surveys and sonde continuous monitoring provides valuable information on daily fluctuations of environmental parameters. This information has been recorded by NERRS, so future monitoring should focus more resources on monthly changes.
- f. *Reduce the number of parameters and increase consistency.* For purposes of investigating nutrient dynamics, several water quality parameters could be dropped from the monitoring activities. Substantial redundancy exists among alkalinity, hardness, conductivity, chloride, and TDS; they are all salinity-related parameters. Measuring them all provides only minimal additional interpretive strength related to nutrients. Because of the existing long-term data set of the NERRS/CDMO for Chl *a*, future monitoring should use the fluorometric method.

In summary, the current study, along with NERRS long-term monitoring effort, provides solid background information for understanding nutrient dynamics in the Weeks Bay system. However, further studies should be conducted to explore the true causal relationship between nutrient input from upstream sources, resulting algal blooms in Weeks Bay; and thus to enhance scientific defensibility of nutrient criteria.



## 11 Literature Cited

- ADEM (Alabama Department of Environmental Management). 2006. National Coastal Assessment Alabama 2000-2004: An Assessment of the Health of the Estuaries of Alabama. Final Report. CR # 82847101. Alabama Department of Environmental Management, Mobile, Alabama.
- ADEM (Alabama Department of Environmental Management). 2010a. Chapter 335-6-10. Water quality criteria. Accessed June 1, 2012.  
[http://water.epa.gov/scitech/swguidance/standards/wqslibrary/al\\_index.cfm](http://water.epa.gov/scitech/swguidance/standards/wqslibrary/al_index.cfm).
- ADEM (Alabama Department of Environmental Management). 2010b. Chapter 335-6-11. Water Use Classifications for interstate and intrastate waters. Accessed June 1, 2012.  
[http://water.epa.gov/scitech/swguidance/standards/wqslibrary/al\\_index.cfm](http://water.epa.gov/scitech/swguidance/standards/wqslibrary/al_index.cfm).
- ADEM (Alabama Department of Environmental Management). 2011. *Quality Assurance Program Plan (QAPP) For Surface Water Quality Monitoring In Alabama*. Prepared for: Alabama Department of Environmental Management, Field Operations Division and Water Division, Montgomery, AL; prepared by: Alabama Department of Environmental Management, Office of Environmental Quality, Montgomery, AL.
- Bricker, S.B., J.G. Ferreira, and T. Simas. 2003. An integrated methodology for assessment of estuarine trophic status. *Ecological Modelling* 169:39–60.
- Boesch, D.F. 2006. Scientific requirements for ecosystem-based management in the restoration of Chesapeake Bay and Coastal Louisiana. *Ecological Engineering* 26:6–26.
- Brown, C.A., W.G. Nelson, B.L. Boese, T.H. Dewitt, P.M. Eldridge, J.E. Kaldy, H. Lee Ii, J.H. Power, and D.R. Young. 2007. *An Approach to Developing Nutrient Criteria for Pacific Northwest Estuaries: A Case Study of Yaquina Estuary, Oregon*. EPA/600/R-07/046. U.S. Environmental Protection Agency, Washington, DC.
- Cleveland, R.B., W.S. Cleveland, J.E. McRae, and I. Terpenning. 1990. STL: A seasonal-trend decomposition procedure based on loess. *Journal of Official Statistics* 6:3–73.
- Dauer, D.M., J.A. Ranasinghe, and S.B. Weisberg. 2000. Relationships between benthic community condition, water quality, sediment quality, nutrient loads, and land use patterns in Chesapeake Bay. *Estuaries* 23(1):83–96.
- Engle, V.D., J.K. Summers, and G.R. Gaston. 1994. A benthic index of environmental condition of Gulf of Mexico Estuaries. *Estuaries* 22(3A):372–384.
- Engle, V.D., and J.K. Summers. 1999. Refinement, validation, and application of a benthic condition index for northern Gulf of Mexico estuaries. *Estuaries* 22(3A):624–635.
- GOMA (Gulf of Mexico Alliance). 2009. *Governors' Action Plan II: 2009–2014*.  
[http://www.gulfofmexicoalliance.org/actionplan/actionplan\\_II.html](http://www.gulfofmexicoalliance.org/actionplan/actionplan_II.html).
- Hagy, J.D., J.C. Kurtz, and R.M. Greene. 2008. *An approach for developing numeric nutrient criteria for a Gulf coast estuary*. EPA/600/R-08/004. U.S. Environmental Protection Agency, Office of Research and Development, National Health and Environmental Effects Research Laboratory, Research Triangle Park, NC.

- Hecky, R.E., and P. Kilham. 1988. Nutrient limitation of phytoplankton in freshwater and marine environments: A review of recent evidence of the effects of enrichment. *Limnology and Oceanography* 22(3):796–822.
- Kerman, J., and A. Gelman. 2007. Manipulating and summarizing posterior simulations using random variable objects. *Statistics and Computing* 17(3):235–244.
- Llansó, R.J., L.C. Scott, J.L. Hyland, D.M. Dauer, D.E. Russell, and F.W. Kurtz. 2002. An estuarine benthic index of biotic integrity for the mid-Atlantic region of the United States. II. Index development. *Estuaries* 25:1231–1242.
- Miller-Way, T., M. Dardeau, and G. Crozier. 1996. *Weeks Bay National Estuarine Research Reserve. An Estuarine Profile and Bibliography*. Technical Report 96-01. Dauphin Island Sea Lab, 101 Bienville Blvd, Dauphin Island, AL.
- Morrison, A.G. 2011. Spatial and Temporal Trends and the Role of Land Use/Cover on Water Quality and Hydrology in the Fish River Watershed. Masters thesis, Auburn University, Auburn, AL.
- Nixon, S., B. Buckley, S. Granger, and J. Bintz. 2001. Responses of very shallow marine ecosystems to nutrient enrichment. *Human and Ecological Risk Assessment* 7(5):1457–1481.
- NRC (National Research Council). 1990. *Managing Troubled Waters. The Role of Marine Environmental Monitoring*. National Research Council, National Academy Press, Washington, DC.
- NRC (National Research Council). 2001. *Assessing the TMDL Approach to Water Quality Management*. National Research Council, National Academy Press, Washington, DC.
- O’Neil, P.E., and R.V. Chandler. 2003. *Water Quality and Biological Monitoring in Weeks Bay Watershed, Alabama. 1994–1998*. Geological Survey of Alabama. Bulletin 173.
- Pinckney, J., R. Papa, and R. Zingmark. 1994. Comparison of high-performance liquid chromatographic, spectrophotometric, and fluorometric methods for determining chlorophyll *a* concentrations in estuarine sediments. *Journal of Microbiological Methods* 19(1):59–66.
- Qian, S.S. 2012. *Personal communication*.
- R Core Team. 2010. *R: A language and environment for statistical computing*. R Foundation for Statistical Computing, Vienna, Austria. ISBN 3-900051-07-0, URL: <http://www.R-project.org/>.
- Plummer, M. 2012. *rjags: Bayesian graphical models using MCMC*. R package version 3-9. <http://CRAN.R-project.org/package=rjags>.
- Ranasinghe, J.A., S.B. Weisberg, R.W. Smith, D.E. Montagne, B. Thompson, J.M. Oakden, D.D. Huff, D.B. Cadien, R.G. Velarde, and K.J. Ritter. 2009. Calibration and evaluation of five indicators of benthic community condition in two California bay and estuary habitats. *Marine Pollution Bulletin* 59:5–13.
- Roegner, G.C., B. Hickey, J. Newton, A. Shanks, and D. Armstrong. 2002. Wind-induced plume and bloom intrusions into Willapa Bay, Washington. *Limnology and Oceanography* 47: 1033–1042.

- Strobel, C.J., and T. Hietmuller. 2001. *National Coastal Assessment: Field Operations Manual*. EPA 620/R-01/003. U.S. Environmental Protection Agency, Office of Research and Development, National Health and Environmental Effects Research Laboratory, Ecology Division, Gulf Breeze, FL. Accessed August 25, 2009. <http://www.epa.gov/emap/nca/html/docs/c2kfm.pdf>.
- Tetra Tech, Inc. 2011a. *Monitoring Design for Determining the Sources, Fate, Transport, and Effects of Nutrients within the Weeks Bay (Alabama) Estuary System*. Prepared for Gulf of Mexico Alliance, Alabama Department of Environmental Management, Montgomery, AL, Mississippi Department of Environmental Quality, Office of Pollution Control, Jackson, MS, by Tetra Tech, Inc., Owings Mills, MD. For more information, contact Mr. Lynn Sisk (334-271-7826, or email, [LS@adem.state.al.us](mailto:LS@adem.state.al.us)).
- Tetra Tech, Inc. 2011b. *Benthic Index of Biological Integrity for Estuarine and Near Coastal Waters of the Gulf of Mexico*. Prepared for the Gulf of Mexico Alliance and Mississippi Department of Environmental Quality, Office of Pollution Control, Jackson, MS, by Tetra Tech, Inc., Center for Ecological Sciences, Owings Mills, MD. For more information, contact Ms. Natalie Guedon-Segrest (601-961-5150, or email, [Natalie\\_Segrest@deq.state.ms.us](mailto:Natalie_Segrest@deq.state.ms.us)). <http://www.gulfofmexicoalliance.org/issues/nutrients.php>.
- Thompson, B., and S. Lowe. 2004. Assessment of macrobenthos response to sediment contamination in the San Francisco estuary, California, USA. *Environmental Toxicology and Chemistry* 23(9):2178–2187.
- USEPA (U.S. Environmental Protection Agency). 2001. *Nutrient Criteria Technical Guidance Manual*. Estuarine and Coastal Marine Waters. EPA-822-B-01-003. U.S. Environmental Protection Agency, Office of Water, Washington, DC.
- USEPA (U.S. Environmental Protection Agency). 2011. *Weeks Bay Water Quality Study Final Report*. U.S. Environmental Protection Agency, Science and Ecosystem Support Division, Athens, GA. Available from Mr. Lynn Sisk (ph. 334-271-7826, or by email, [LS@adem.state.al.us](mailto:LS@adem.state.al.us)).
- Weeks Bay National Estuarine Research Reserve. 2007. *Management Plan*. <http://nerrs.noaa.gov/WeeksBay/welcome.html>.
- WKB NERR Nutrient Metadata. 2008. NERR site nutrient metadata form with explanations. Weeks Bay (WKB) NERR Nutrient Metadata. January–December 2003. Updated June 3, 2008. <http://cdmo.baruch.sc.edu/>.
- Weisberg, S.B., J.A. Ranasinghe, D.M. Dauer, L.C. Schaffner, R.J. Diaz, and J.B. Frithsen. 1997. An estuarine benthic index of biotic integrity (B-IBI) for Chesapeake Bay. *Estuaries* 20(1):149–158.



*Attachment*

**Taxonomic Data Quality Control Report**





# Taxonomic Data Quality Control Report

<b>Report completed (date)</b>	August 06, 2012
<b>Tetra Tech project number</b>	100-BLT-T28423-01
<b>Project name</b>	SFTE Study for Pilot Nutrient Criteria in Weeks Bay, Alabama
<b>Client</b>	Alabama Department of Environmental Management, Mississippi Department of Environmental Quality, Gulf of Mexico Alliance
<b>Client contact</b>	Mr. Lynn Sisk ([334]) 271-7826; Ms. Kay Whittington ([601] 961-5729)
<b>Primary taxonomist(s)</b>	Dr. Jerry McLelland (T1, Gulf Benthic Taxonomy Assessment [GBTA])
<b>QC taxonomist(s)</b>	Dr. Carey Gelpi (T2, Louisiana State University [LSU])
<b>QC analyst</b>	J. Stribling

## Table of contents

**TEST CONDITIONS AND NARRATIVE SUMMARY.....page 2**  
**SUMMARY STATISTICS (*by sample lot*).....page 2**  
**SUMMARY STATISTICS (*by individual samples*).....page 3**  
**TAXON BY TAXON COMPARISONS (*within samples*).....page 3**  
**LIST OF CORRECTIVE ACTIONS OR OTHER ISSUES.....page 4**

*Prepared by:* Tetra Tech, Inc., Center for Ecological Sciences, 400 Red Brook Blvd., Suite 200, Owings Mills, Maryland 21117-5172 (with questions, contact James Stribling [410-356-8993], or [james.stribling@tetrattech.com](mailto:james.stribling@tetrattech.com))



## Taxonomic Data Quality Control Report

**Report completed (date)** August 06, 2012  
**Tetra Tech project number** 100-BLT-T28423-01  
**Project name** SFTE Study for Pilot Nutrient Criteria in Weeks Bay, Alabama  
**Client** Alabama Department of Environmental Management, Mississippi Department of Environmental Quality, Gulf of Mexico Alliance  
**Client contact** Mr. Lynn Sisk ([334]) 271-7826; Ms. Kim Caviness ([601] 961-5390)  
**Primary taxonomist(s)** Dr. Jerry McLelland (T1, Gulf Benthic Taxonomy Assessment [GBTA])  
**QC taxonomist(s)** Dr. Carey Gelpi (T2, Louisiana State University [LSU])  
**QC analyst** J. Stribling

**Test conditions and narrative summary** – Three (3) benthic macroinvertebrate samples were randomly selected from the 6 locations sampled in Weeks Bay, Alabama, as part of the Sources, Fate, Transport, and Effects (SFTE) Study to Develop Pilot Nutrient Criteria. These results represent a direct comparison of identification results by independent taxonomists in separate laboratories; the primary taxonomist and taxonomic results are always represented as T1, and the QC taxonomist and taxonomic results, as T2. Percent taxonomic disagreement (PTD) ranged from 2.0-9.0, with a mean of 6.0, substantially better than the typical 15% measurement quality objective used for many programs (though none were specified for this project). Overall, the comparisons were excellent, with substantial consistency (good precision, low PTD), indicating good consistency in sample treatment. No samples exceeded the MQO, and the overall data quality of the dataset is acceptable for additional analyses.

**Standard operating procedures (SOP) for identifications documented and provided to all primary and QC taxonomists?** Taxonomists were informed they should identify specimens to lowest practical taxonomic level.

Additional comments: None.

### SUMMARY STATISTICS (by sample lot)

<b>Number of samples</b>	3
<b>Percent of sample lot</b>	50%
<b>Percent taxonomic disagreement (PTD)</b>	
Average	3.6
Standard deviation	2.0
Measurement quality objective	15
<i>No. samples exceeding</i>	<i>0</i>
<b>Percent difference in enumeration (PDE)</b>	
Average	0.6
Standard deviation	0.8
Measurement quality objective	5
<i>No. samples exceeding</i>	<i>0</i>



**Hierarchical target levels**

All specimens should be identified to lowest practical level.

The following provides definitions for abbreviations and column headers in tables found in subsequent pages of this report:

	<b>Abbreviations</b>	<b>Column headers</b>
A	no_ind_T1	number of individuals counted by primary taxonomist
B	no_ind_T2	number of individuals counted by QC taxonomist
C	Matches	number of agreements between the two taxonomists
D	PDE	percent difference in enumeration
E	PTD	percent taxonomic disagreement
F	Target_T1	number of individuals identified to target level, primary taxonomist
G	Target_T2	number of individuals identified to target level, QC taxonomist
H	PTC_T1	percent taxonomic completeness, primary taxonomist
I	PTC_T2	percent taxonomic completeness, QC taxonomist
J	PTC (abs diff)	percent taxonomic completeness (absolute difference)
K	Diff_Strt	number of straight taxonomic disagreements
L	Diff_Hier	number of hierarchical differences
M	Diff_Miss	number of missing specimens

**SUMMARY STATISTICS (by individual samples)**

<b>Sample ID</b>	<b>A</b>	<b>B</b>	<b>C</b>	<b>D</b>	<b>E</b>	<b>F</b>	<b>G</b>	<b>H</b>	<b>I</b>	<b>J</b>
WKBB-2	74	74	73	0	1.4	74	74	100	100	0
WKBB-4	102	99	98	1.5	3.9	100	98	98	99	1
WKBB-6	112	111	106	0.4	5.4	111	110	99.1	99.1	0

**TAXON BY TAXON COMPARISONS (within samples)**

<b>Sample ID</b>	<b>Taxon</b>	<b>A</b>	<b>B</b>	<b>C</b>	<b>K</b>	<b>L</b>	<b>M</b>
WKBB-2	Nemertea	3	3	3	0	0	0
WKBB-2	Streblospio gynobranchiata	29	30	29	0	0	0
WKBB-2	Mediomastus ambiseta	39	38	38	0	0	0
WKBB-2	Glycinde solitaria	3	3	3	0	0	0
WKBB-4	Nemertea	1	0	0	0	0	1
WKBB-4	Tubificidae	1	0	0	0	0	1
WKBB-4	Tanypus	0	0	0	0	0	0
WKBB-4	Kinberginereis	0	1	0	1	0	0
WKBB-4	Stenoninereis martini	1	0	0	0	0	0



TETRA TECH

Sample ID	Taxon	A	B	C	K	L	M
WKBB-4	Streblospio gynobranchiata	43	43	43	0	0	0
WKBB-4	Capitella capitata	1	1	1	0	0	0
WKBB-4	Mediomastus ambiseta	54	54	54	0	0	0
WKBB-4	Ostracoda	1	0	0	0	0	1
WKBB-6	Nemertea	2	4	2	2	0	0
WKBB-6	Membranipora	1	0	0	0	0	1
WKBB-6	Streblospio gynobranchiata	45	46	45	0	0	0
WKBB-6	Capitella capitata	7	3	3	0	0	0
WKBB-6	Heteromastus filiformis	0	1	0	1	0	0
WKBB-6	Mediomastus ambiseta	52	52	52	0	0	0
WKBB-6	Glycinde solitaria	1	0	0	0	1	0
WKBB-6	Goniadidae	0	1	0	0	0	0
WKBB-6	Sigambra bassi	2	2	2	0	0	0
WKBB-6	Americamysis bahia	2	2	2	0	0	0

**List of corrective actions or other issues**

1. Develop common understanding of characters separating *Streblospio benedicti* from *S. gynobranchiata*
2. Develop common understanding of characters separating *Mediomastus californiensis* from *M. ambiseta*
3. Make sure to record and transfer any slide-mounted specimens to T2

*Appendix B*

*Hydrodynamics and Water Quality Modeling for  
Weeks Bay, Alabama*



# Sources, Fate, Transport, and Effects (SFTE) of Nutrients as a Basis for Protective Criteria in Estuarine and Near-Coastal Waters

## Weeks Bay, Alabama Pilot Study Hydrodynamics and Water Quality Modeling

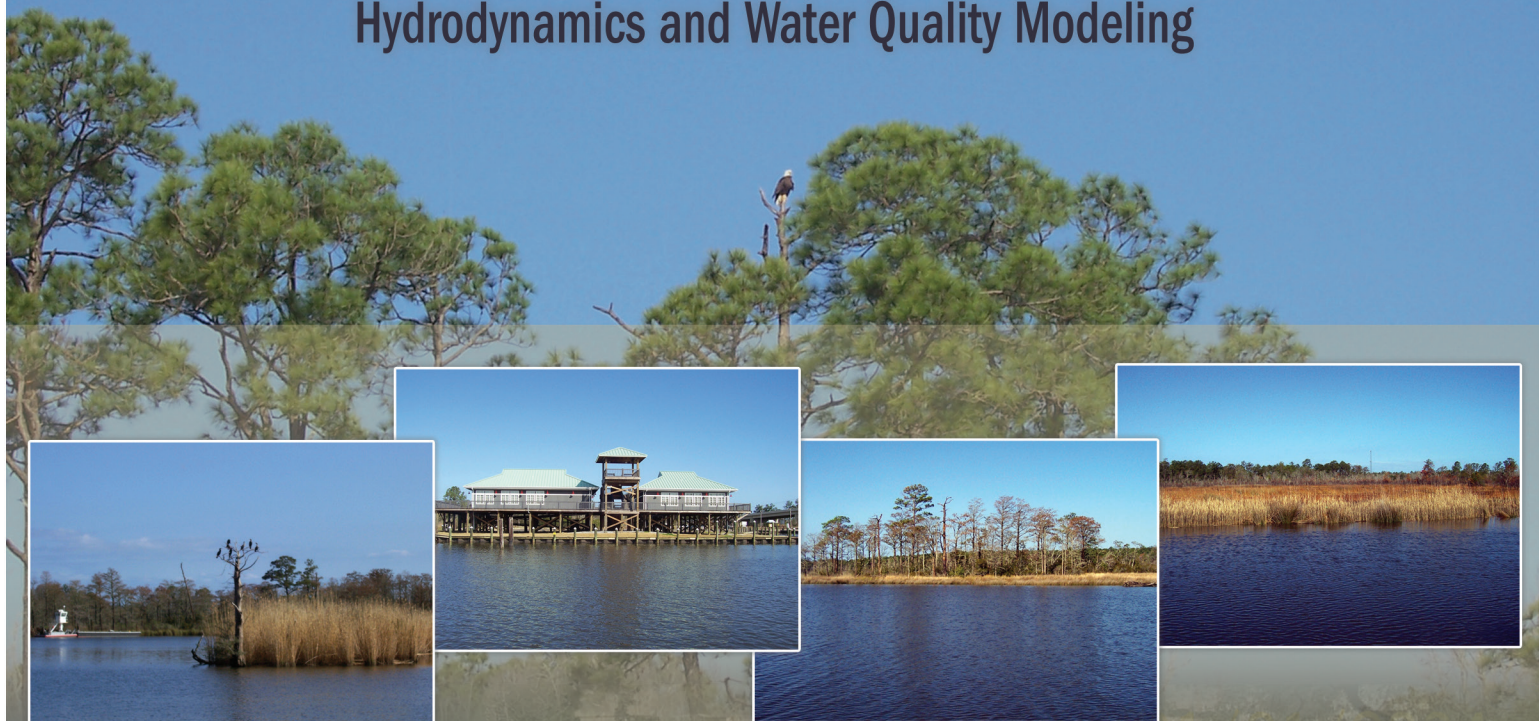

Prepared for:



The Gulf of Mexico Alliance  
1141 Bayview Avenue  
Biloxi, MS 39530

Under the direction of:



1400 Coliseum Boulevard  
Montgomery, AL 36110



515 Amite Street  
Jackson, MS 39201

March 29, 2013



# **Sources, Fate, Transport, and Effects (SFTE) of Nutrients as a Basis for Protective Criteria in Estuarine and Near-Coastal Waters**

## **Weeks Bay, Alabama Pilot Study**

### *Hydrodynamics and Water Quality Modeling*

*Prepared for*

Gulf of Mexico Alliance  
1141 Bayview Avenue  
Biloxi, MS 39530

*Under the direction of*

Alabama Department of Environmental Management,  
Water Quality Branch, 1400 Coliseum Boulevard,  
Montgomery, AL 36110

*and*

Mississippi Department of Environmental Quality,  
Office of Pollution Control, 515 Amite Street,  
Jackson, MS 39201

*Prepared by*

Tetra Tech, Inc.,  
2110 Powers Ferry Road SE, Suite 202  
Atlanta, GA 30339,  
and 400 Red Brook Boulevard, Suite 200,  
Owings Mills, MD 21117-5172

March 29, 2013

## Abstract

Hydrodynamic and water quality models were developed to simulate the physical, chemical and biological processes in Weeks Bay, a sub-estuary of Mobile Bay, as part of a pilot study by the Gulf of Mexico Alliance (GOMA) Nutrient Priority Issue Team (PIT) regarding the sources, fate, and transport of nutrients to support the development of nutrient criteria. Three modeling systems were used: the Loading Simulation Program in C++ (LSPC) was used to represent hydrological and water quality conditions in the watersheds and calculate nutrients loads to the bay; the Environmental Fluid Dynamics Code (EFDC) was used to simulate hydrodynamics of Weeks Bay; and the Water Quality Analysis Simulation Program (WASP version 7.41) was used to simulate spatial-temporal dynamics of nutrients, phytoplankton, dissolved oxygen (DO) and other water quality constituents. Three nutrient loading scenarios were modeled to evaluate the effects of nutrient reduction on response parameters, or endpoints, including chlorophyll *a*, DO, primary production and water clarity. Modeled scenarios included an existing conditions scenario (S1), a natural conditions scenario (S2) in which anthropogenic sources of pollution were essentially removed, and a scenario simulating a 50 percent reduction in the anthropogenic part of the nutrient load (S3). Analysis of loading scenario outputs can help characterize the sensitivity of the Weeks Bay endpoints to anthropogenic nutrient loads. For the natural conditions scenario the primary production rate decreased by 27 percent. The correspondent decrease for the 90<sup>th</sup> percentile of chlorophyll *a* was 11 percent. Water clarity showed little sensitivity to changes in nutrient loads. Water clarity in Weeks Bay is primarily influenced by colored waters and total suspended solids. Alabama DO criteria were exceeded in all reduction scenarios, with just as many exceedances in the nutrient reduction scenarios as in the existing conditions scenario. Modeling can be used to determine the nutrient reductions necessary to meet desired endpoint values; however, a principal recommendation in this report is that an additional model scenario be developed to evaluate the effects of increases in nutrient loadings. The information resulting from this study will contribute to developing a consistent, integrated approach to nutrient criteria development for coastal waters along the Gulf of Mexico.



## Acknowledgment

This project was funded by the National Oceanic and Atmospheric Administration through a grant to the Mississippi Department of Environmental Quality (MDEQ) (no. NA08NOS4730395). As the lead member agency for the Nutrients Priority Issues Team in GOMA, the MDEQ administered the project as Work Order no. 11-00107TT-01 to Tetra Tech, Inc. (as part of contractual agreement no. 11-00107) The Alabama Department of Environmental Quality (ADEM) was the client lead for all technical and procedural issues.

The primary authors are Yuri Plis, Julie Kaplan, Madhu Akasapu-Smith, Misha Plis, Rishab Mahajan, and Brian Watson (Tetra Tech, Inc., Atlanta, GA). They were assisted through discussion, document reviews, and data acquisition by James Stribling, Michael Paul, and Lei Zheng (Tetra Tech, Inc., Owings Mills, MD). Technical overview, document reviews were provided by Mr. Lynn Sisk and Mr. Chris Johnson (ADEM-Water Division-Water Quality Branch), Mr. Fred Leslie (ADEM-Field Operations Division), Ms. Kim Caviness (MDEQ-Water Quality Standards and Special Projects Branch), Ms. Kay Whittington (MDEQ-Watershed Management Branch). Kay Whittington was the MDEQ project manager, Ann Porter is the GOMA Nutrient PIT coordinator, and Mr. Ray Montgomery is overall contracts manager.

Proper citation of this report:

GOMA (Gulf of Mexico Alliance). 2013. *Sources, Fate, Transport, and Effects (SFTE) of Nutrients as a Basis for Protective Criteria in Estuarine and Near-Coastal Waters. Weeks Bay, Alabama Pilot Study. Hydrodynamics and Water Quality Modeling*. Prepared for the Gulf of Mexico Alliance, Nutrients Priority Issues Team (Alabama Department of Environmental Management, and the Mississippi Department of Environmental Quality), by Tetra Tech, Inc., Atlanta, GA, and Owings Mills, MD.

For further information, contact Mr. Lynn Sisk (334-271-7826, [LS@adem.state.al.us](mailto:LS@adem.state.al.us)), Ms. Kim Caviness (601-961-5390, [kim\\_caviness@deq.state.ms.us](mailto:kim_caviness@deq.state.ms.us)), or Ms. Kay Whittington (601-961-5729, [kay\\_whittington@deq.state.ms.us](mailto:kay_whittington@deq.state.ms.us)).

## Contents

1	Introduction .....	B-1
2	Modeling Approach.....	B-3
2.1	LSPC Watershed Model.....	B-3
2.2	EFDC Hydrodynamic Model .....	B-3
2.3	WASP Water Quality Model.....	B-4
2.4	Model Linkage .....	B-4
2.5	Light Attenuation Modeling Approach .....	B-5
2.6	Calibration and Validation .....	B-6
2.7	Selection of Nutrient Loading Scenarios for Weeks Bay Model .....	B-7
3	Weeks Bay Watershed Model .....	B-8
3.1	Watershed Delineation .....	B-8
3.2	Soils.....	B-8
3.3	Meteorological Data.....	B-9
3.4	Reach Characteristics .....	B-10
3.5	Land Use Representation .....	B-10
3.6	Point Source Discharges.....	B-11
4	Weeks Bay Hydrodynamic and Water Quality Model Setup.....	B-12
4.1	Model Segmentation .....	B-12
4.2	Weeks Bay Monitoring Data for Calibration .....	B-14
4.3	Hydrodynamic Model Forcing Conditions.....	B-18
4.4	Water Quality Model Forcing Conditions.....	B-18
5	Weeks Bay Model Calibration and Validation.....	B-21
5.1	Hydrodynamic Model Calibration and Validation Analysis.....	B-21
5.2	Water Quality Calibration and Validation Analysis.....	B-22
6	Analysis of Nutrient Loading Scenarios.....	B-24
6.1	Effect of Decreased Nutrient Loads on Primary Production.....	B-25
6.2	Effect of Decreased Nutrient Loads on Chlorophyll a .....	B-25
6.3	Effect of Decreased Nutrient Loads on Dissolved Oxygen.....	B-26
6.4	Effect of Decreased Nutrient Loads on Water Clarity .....	B-26
6.5	Numeric Nutrient Criteria .....	B-27
7	Summary and Conclusions.....	B-28
8	References .....	B-30

## Appendices

- Appendix A Modeling of Hydrological Regime of Weeks Bay: Calibration and Validation
- Appendix B Modeling of Water Quality of Weeks Bay: Calibration and Validation
- Appendix C Modeling of Water Quality of Weeks Bay: Spatial Distributions of Water Quality Constituencies

## Figures

Figure 1. Location of Weeks Bay in the Mobile Bay system. ....	B-2
Figure 2. Aerial image plan view of Weeks Bay, Alabama. ....	B-2
Figure 3. Linkage among LSPC, EFDC, and WASP models. ....	B-5
Figure 4. Delineation of the lateral watersheds draining to Mobile Bay, Alabama. ....	B-9
Figure 5. Orthogonal curvilinear grid of Weeks Bay. ....	B-12
Figure 6. Weeks Bay bathymetry. ....	B-13
Figure 7. Monitoring stations in Weeks Bay. ....	B-14

## Tables

Table 1. Distribution of land use types in the Weeks Bay watershed. ....	B-11
Table 2. Point source discharges in Weeks Bay watershed model. ....	B-11
Table 3. Summary of data collected by NERRS. ....	B-15
Table 4. Summary of monitoring data collected as part of this study. ....	B-16
Table 5. Rates and coefficients for Weeks Bay water quality model. ....	B-19
Table 6. General calibration/validation targets for EFDC/WASP7 applications. ....	B-21
Table 7. Quality of salinity and temperature calibration of Weeks Bay model. ....	B-22
Table 8. Comparison of simulated and measured depth dynamics at NERRS monitoring stations. ....	B-22
Table 9. Quality of calibration and validation of Weeks Bay water quality model. ....	B-23
Table 10. S2 to S1 nutrient load ratios. ....	B-24
Table 11. S3 to S1 nutrient load ratios for 50 percent anthropogenic nutrient load reduction. ....	B-24
Table 12. Primary production rates in Weeks Bay. ....	B-25
Table 13. Surface phytoplankton biomass (90 <sup>th</sup> percentile) in Weeks Bay. ....	B-25
Table 14. Percent model exceedances of Alabama DO criterion under three scenarios. ....	B-26
Table 15. Changes in light extinction coefficient - $K_d$ ( $m^{-1}$ ) and photic zones –PHZ (m) under three scenarios. ....	B-27
Table 16. Example of numeric nutrient criteria. ....	B-27

## Acronyms and Abbreviations

ADEM	Alabama Department of Environmental Management
BOD	biochemical oxygen demand
CDOM	colored dissolved organic matter
CBOD <sub>1</sub>	carbonaceous biochemical oxygen demand 1
CBOD <sub>2</sub>	carbonaceous biochemical oxygen demand 2
CBOD <sub>3</sub>	carbonaceous biochemical oxygen demand 3
DC	detrital carbon
DN	detrital nitrogen
DO	dissolved oxygen
DOC	dissolved organic carbon
DP	detrital phosphorus
EFDC	Environmental Fluid Dynamics Code
EPA	U.S. Environmental Protection Agency
FTABLE	function table
GOMA	Gulf of Mexico Alliance
LSPC	Loading Simulation Program in C++
MDAS	Mining Data Analysis System
NED	National Elevation Dataset
NERRS	National Estuarine Research Reserve System
NHD	National Hydrography Dataset
NLCD	National Land Cover Database
N-NH <sub>4</sub>	ammonia nitrogen
N-NO <sub>x</sub>	nitrate+nitrite nitrogen
NOAA	National Oceanic and Atmospheric Administration
NRCS	Natural Resources Conservation Service
ON	dissolved organic nitrogen
OP	organic phosphorus
P-PO <sub>4</sub>	orthophosphate
RMU	reduced modeling unit
SOD	sediment oxygen demand
SSURGO	Soil Survey Geographic Database
TMDL	total maximum daily load
TN	total nitrogen
TP	total phosphorus
TSS	total suspended solids
USGS	U.S. Geological Survey
WASP7	Water Quality Analysis Simulation Program, version 7.41
WSE	water surface elevation

## 1 Introduction

Excess inputs of nitrogen and phosphorus in upland and coastal waters can be harmful to aquatic ecosystems, both directly—through the production of excess plant and algal growth, and indirectly—through reduced clarity, reduced oxygen levels due to respiration as algae and plants decompose, and the loss of species resulting from these habitat impacts. Primary sources of nitrogen and phosphorus to aquatic ecosystems include waste water effluent, atmospheric deposition, landfill leachate, and runoff from commercial and residential fertilizer and manure applications.

Federal and state environmental agencies are seeking to improve and enhance protection of aquatic life from the detrimental effects of nitrogen/phosphorus pollution through deriving and implementing numeric nutrient criteria. Water quality criteria are a critical part of water quality standards, which serve multiple components of water quality regulatory programs including permitting, assessment, and restoration goals.

In 2004 the Gulf of Mexico Alliance (GOMA) was formed among Alabama, Florida, Louisiana, Mississippi, and Texas to increase regional collaboration and enhance the ecological and economic health of the Gulf of Mexico. GOMA has identified priority issues that are regionally significant and can be effectively addressed through increased regional collaboration. GOMA identified the improvement of water quality as one of the key issues to address by increasing cooperation at the local, state, and federal levels. For this, GOMA initiated the development of a consistent and integrated approach for developing nutrient criteria for the coastal waters along the Gulf of Mexico. The alliance conducted a pilot study was conducted to collect data and information regarding the sources, fate, and transport of nutrients to help develop nutrient criteria for Weeks Bay, Alabama.

The purpose of this project is to support the development of pilot numeric nutrient criteria in Weeks Bay. To develop these criteria, a linkage must be defined between the nutrient levels and adverse effects on designated uses represented by response endpoints. For this study, we used mathematical modeling as a tool to investigate the cause-and-effect relationship between the pollutants of concern (total nitrogen [TN] and total phosphorus [TP]), and the selected response parameters or endpoints (chlorophyll *a*, water clarity, and dissolved oxygen [DO]).

The general morphological features of the Weeks Bay system and major physical processes in the system are documented in Miller-Way et al. (1996). Weeks Bay is a small, shallow, tributary estuary on the eastern shore of the Mobile Bay Estuary in the northern Gulf of Mexico (Figure 1). It is nearly diamond-shaped (Figure 2) with a surface area of approximately 6.9 square kilometers (1,718 acres). It has a 3.4-kilometer longitudinal axis running north-south from the head of the bay, from the Fish River inflow, to its mouth, where it exchanges water with Mobile Bay. The widest section of the bay, 3.1 kilometers, occurs in the central region, where the Magnolia River discharge enters along the eastern shore.

The bay has a mean water depth of approximately 1.3 meters (m). A small, 5–7 m deep scour feature is in the narrow mouth of the bay, and a similar scour feature, 3–4 m deep, is in the Fish River about 200 m upstream from where it empties into the bay (adjacent to the Hwy. 98 bridge). Water depths in the 2–3 m range are in the lower bay, whereas depths in the upper bay are often less than or equal to 1 m. Tides are principally daily and have a mean range of approximately 0.4 m. Both tidal and subtidal (occurring less frequently than the tides, i.e., over periods greater than 1 day) currents measured just inside the mouth of the bay flow up to 40 cm s<sup>-1</sup>. Direct freshwater discharge into the bay comes from the Fish and Magnolia Rivers. Mean combined discharge for 2008–2011 is about 3.6 m<sup>3</sup> s<sup>-1</sup>. The Fish River is the principal source of freshwater, accounting for approximately 72 percent of the inflow.

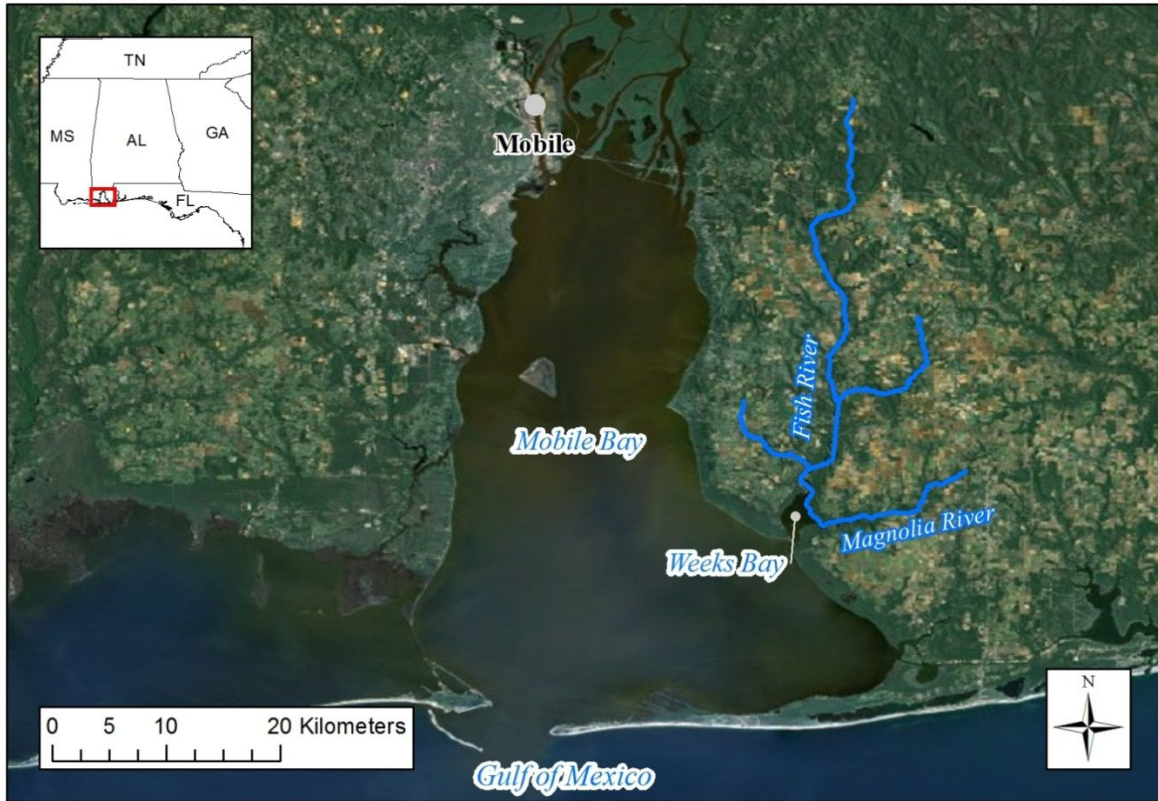

Figure 1. Location of Weeks Bay in the Mobile Bay system.

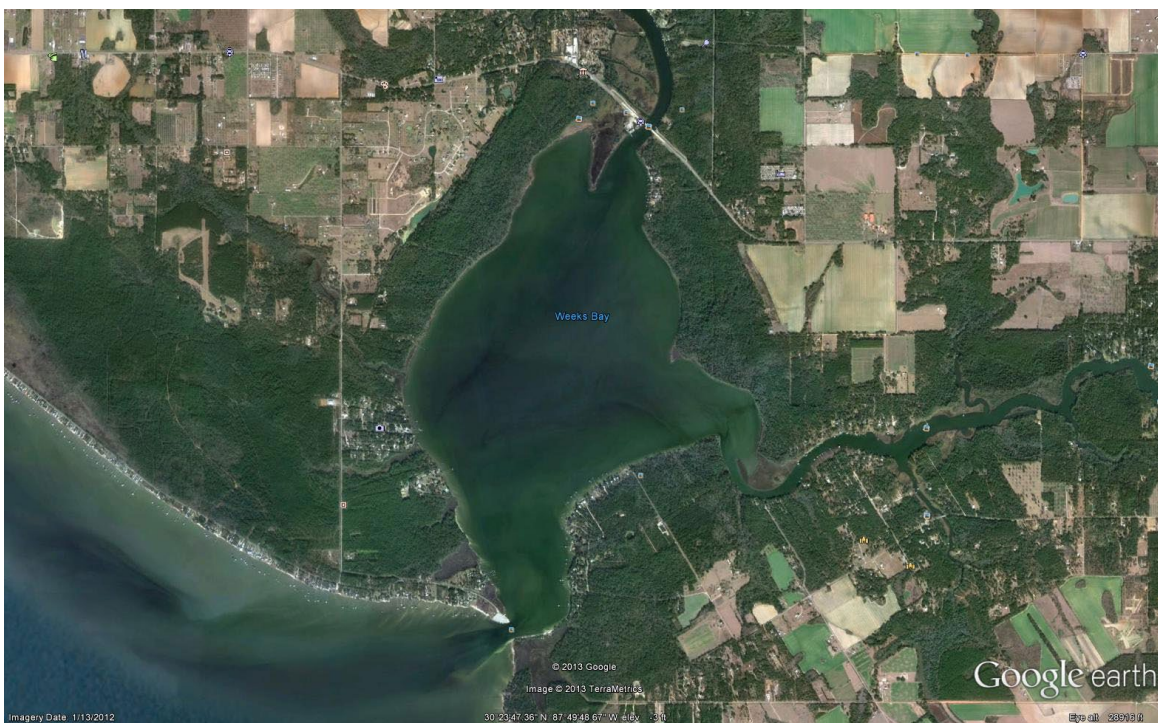

Figure 2. Aerial image plan view of Weeks Bay, Alabama.

## 2 Modeling Approach

A set of mathematical models of physical, chemical and biological processes was developed for Weeks Bay and surrounding watersheds. The models are based on the following computational codes:

- The Loading Simulation Program in C++ (LSPC) was used to represent the hydrological and water quality conditions in the watersheds and calculate nutrient loads to the bay.
- The Environmental Fluid Dynamics Code (EFDC) was used to simulate the hydrodynamics of Weeks Bay.
- The Water Quality Analysis Simulation Program (WASP version 7.41) was used to simulate the spatial-temporal dynamics of nutrients, phytoplankton, DO and other water quality constituents in Weeks Bay.

A detailed description of each model is given below.

### 2.1 LSPC Watershed Model

LSPC was used to develop a watershed model to represent the hydrologic and water quality conditions in the watershed discharging to Weeks Bay. LSPC is a comprehensive data management and modeling system that is capable of representing loading, both flow and water quality, from point and nonpoint sources and simulating in-stream processes. It is a dynamic watershed model driven by time-variable weather input data and is capable of simulating flow, sediment, metals, nutrients, pesticides, and other conventional pollutants, as well as temperature and pH for pervious and impervious lands and waterbodies. LSPC was configured to simulate the watershed as a series of hydraulically connected subwatersheds in which the model estimates the surface water runoff and the advective transport of constituents. LSPC is based on the Mining Data Analysis System, with modifications for non-mining applications such as nutrient and fecal coliform modeling. Mining Data Analysis System was developed by the U.S. Environmental Protection Agency (EPA) Region 3 through mining total maximum daily load (TMDL) applications.

### 2.2 EFDC Hydrodynamic Model

The three-dimensional EFDC model was developed by (Hamrick 1992; Tetra Tech 2002, 2007) and based on three-dimensional primitive variable vertically hydrostatic equations of motion for turbulent flow. It includes dynamically coupled salinity and temperature transport.

The model employs a curvilinear-orthogonal horizontal grid and a sigma or terrain-following vertical grid. The EFDC hydrodynamic model employs a semi-implicit, conservative finite volume-finite difference solution scheme for the hydrostatic primitive equations with either two- or three-level time stepping. The semi-implicit scheme is based on external mode splitting with the external mode being implicit with respect to the water surface elevation and the internal mode being implicit with respect to vertical turbulent momentum diffusion. Advective and Coriolis-curvature accelerations in both the external and internal modes are represented by explicit conservative formulations. Salinity and temperature transport are simultaneously solved with the hydrodynamics and dynamically coupled through an equation of state. The hydrodynamic component includes two additional scalar transported variables, a reactive variable that can be used to represent dye or pathogenic organisms, and a shellfish larvae variable that includes a number of vertical swimming behavior options. Scalar transport options include a number of high accuracy advection schemes. Additional features include the Mellor-Yamada turbulence closure formulation, simulation of drying and wetting, representation of hydraulic control structures, vegetation resistance, wave-current boundary layers and wave induced currents, and dynamic

time stepping. An embedded single- and multi-port buoyant jet module is included for coupled near-field and far-field mixing analysis.

The EFDC model simulates the hydrodynamic and constituent transport and then writes a hydrodynamic linkage file for a water quality model such as the WASP7 model. This model linkage, from EFDC hydrodynamics to WASP water quality, has been applied in many EPA Region 4 projects in support of TMDLs and has been well tested (Wool et al. 2003).

## **2.3 WASP Water Quality Model**

WASP7 was used for the water quality model (Ambrose et al. 1988). It is a dynamic compartment-modeling program for aquatic systems, including both the water column and the underlying bottom sediment layer. The time-varying processes of advection, dispersion, point and diffuse mass loading and boundary exchange are represented in the basic program. Water quality processes are represented in special kinetic subroutines that are either chosen from a library or written by the user. WASP is structured to permit easy substitution of kinetic subroutines into the overall package to form problem-specific models. WASP7 comes with two such models, TOXI for toxicants and EUTRO for conventional water quality.

The hydrodynamic file generated by EFDC is compatible with WASP7 and it transfers segment volumes, velocities, temperature and salinity, as well as flows between segments. The time step is also set in WASP7 on the basis of the hydrodynamic simulation.

WASP7 helps users interpret and predict water quality responses to natural phenomena and anthropogenic pollution for various pollution management decisions. It has a long history of application to various problems. Some applications have been validated with field data or verified by model experiments and reviewed by independent experts. Different versions of WASP have been used to examine eutrophication of Tampa Bay; phosphorus loading to Lake Okeechobee; eutrophication of the Neuse River and estuary (Wool et al. 2003); eutrophication and polychlorinated biphenyls pollution of the Great Lakes (Thomann et al. 1975), eutrophication of the Potomac Estuary (Thomann and Fitzpatrick 1982).

## **2.4 Model Linkage**

These models were used to simulate the hydrology and water quality of the watersheds and the hydrodynamics and water quality of the bay. The LSPC model was used to provide tributary water quality concentrations to WASP7 model. EFDC and WASP7 are linked through a hydrodynamic linkage file. The hydrodynamic linkage file provides the inter-cell flow and velocities and the cell volume, temperature, and salinity at each simulation time step. Figure 3 illustrates interactions among the three models.



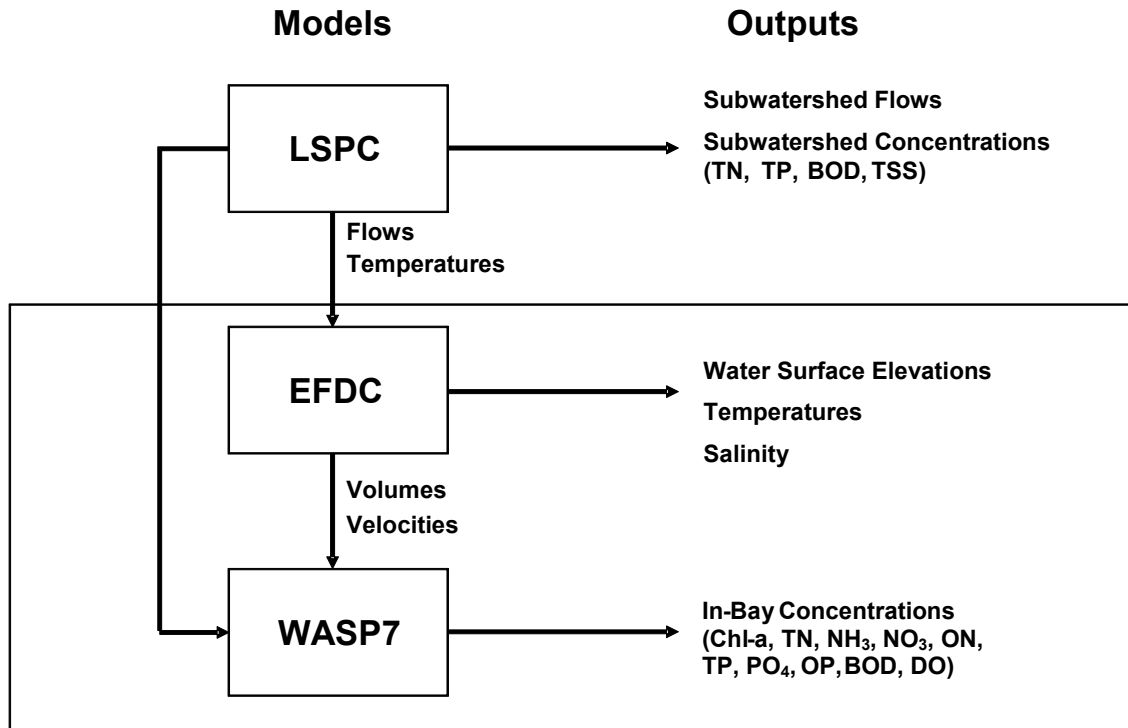

Figure 3. Linkage among LSPC, EFDC, and WASP models.

## 2.5 Light Attenuation Modeling Approach

The water quality model of Weeks Bay, which was created with WASP 7.41, uses the Beer-Lambert function of light attenuation with depth ( $I_z / I_0 = e^{-kz}$ ), where  $I_0$  is the light just beneath the water surface [langleys (ly)/day], and  $z$  is depth (m).

The total light extinction coefficient is calculated as

$$k = k_{shd} + k_{solid} + k_{doc1}$$

where  $k_{shd}$  is the algal self-shading;  $k_{solid}$  is the total suspended solids (TSS) light extinction;  $k_{doc1}$  represents dissolved organic carbon (DOC) light extinction.

The Weeks Bay water quality model setup assumes that DOC represents colored dissolved organic matter (CDOM) which is characteristic of many rivers draining coastal plain forests of the southeastern United States especially *blackwater* rivers, many of which have been shown to exhibit CDOM content (often more than 20 milligrams per liter [mg/L] as carbon). WASP variable carbonaceous biochemical oxygen demand (CBOD<sub>1</sub>) was selected as substitute of CDOM.

The water quality model setup assumes that LSPC-calculated biochemical oxygen demand (BOD) represents conservative CDOM (as CBOD<sub>1</sub>) and degradable DOC (as CBOD<sub>2</sub>); CBOD<sub>3</sub> represents all relatively labile algal CBOD loads.

## 2.6 Calibration and Validation

The American Society of Testing and Materials defines calibration and validation as follows (ASTM 1984):

- Calibration—a test of the model with known input and output information that is used to adjust or estimate factors for which data are not available.
- Validation—comparison of model results with numerical data independently derived from experiments or observations of the environment.

Ideally, a model should be constructed on the basis of the knowledge available about the system. In reality, there are usually too few field observations, the time series are too short, or the number of parameters to be identified too large to completely construct a model from measurements; therefore, calibration becomes essential.

Calibration focuses on the comparison between model results and field observations. An important principle is the smaller the deviation between the calculated model results and the field observations, the better the model. Calibration is an iterative procedure of parameter evaluation and refinement, as a result of comparing simulated and observed model constituencies and processes.

Many factors determine the deviation between the model results and the field observations:

- Conceptual errors—inaccurate model definitions, such as oversimplified complex structure, neglecting certain processes, or incomplete mathematical descriptions.
- Parameter values—hydrodynamic and water quality models entail many parameters whose values are not exactly known.
- Errors in driving forces—for example, errors in the model's boundary or meteorological conditions.
- Measurement errors in field observations.

The calibrated model must be able to reproduce field observations from an independent data set. Confidence in the model can be increased only by experimenting with the model, i.e., by carrying out validation tests. If validation has been done, particularly for situations that closely resemble the situation for which the model is to make predictions, there is increased confidence that the prediction will be reasonably reliable but is still by no means certain. It is important that the calibration and validation data cover the range of conditions over which predictions are desired (McCutcheon 1989).

Although no consensus on model calibration and validation criteria is apparent from past and recent model-related literature, a number of *basic truths* are evident and accepted by most modelers (Donigian 2000):

- Models are approximations of reality; they cannot precisely represent natural systems.
- There is no single, accepted statistic or test that determines whether a model is validated.
- Both graphical comparisons and statistical tests are required in model calibration and validation.
- Models cannot be expected to be more accurate than the errors (confidence intervals) in the input and observed data.

## **2.7 Selection of Nutrient Loading Scenarios for Weeks Bay Model**

Three model scenarios were run and analyzed for Weeks Bay: existing conditions (S1), no anthropogenic nutrient loads (S2) and 50 percent reduction of existing anthropogenic nutrient loads (S3).

The first scenario (S1) produces water quality outputs that correspond to existing nutrient loads. S1 is the calibration and validation scenario. Typically, the existing conditions scenario is considered by regulatory agencies as a baseline scenario that should trend toward improved water quality by decreasing the nutrient loads.

The second scenario (S2) can also be referred to as the natural conditions scenario. This scenario represents the water quality regime that would develop if all anthropogenic sources of nutrient pollution were eliminated, and only nutrient discharges from natural sources could reach the bay. The non-anthropogenic conditions were developed by setting the nutrient loads of all point sources to zero and the nutrient loads of all nonpoint sources to the level of forest or wetland land use. This scenario might or might not represent a desirable water quality condition, depending on the level of nutrients needed to support a healthy ecosystem.

The third scenario (S3) is a load-reduction scenario. For Weeks Bay, a 50 percent reduction in the anthropogenic part of the nutrient load was selected as an example to evaluate of the effects of nutrient load reductions.

This three-scenario approach allows evaluation of the sensitivity of the Weeks Bay system to nutrient load reductions and provides information helpful for evaluating achievable numeric nutrient criteria. The reduction scenario ultimately used for developing numeric nutrient criteria can be selected by running multiple simulations with alternative loadings (alternative Ks), and comparing the simulation outputs to established endpoint targets. In addition, the model can be used to evaluate whether water quality conditions are more responsive to changes in nitrogen loading, changes in phosphorus loading, or a combination of the two.

### 3 Weeks Bay Watershed Model

The watershed model represents the variability of pollutant source contributions through dynamic representation of hydrology and land practices, and includes all point source contributions. Key components of the watershed modeling are the following:

- Watershed delineation
- Simulation period
- Soils
- Meteorological data
- Reach characteristics
- Land use representation
- Point source discharges

#### 3.1 Watershed Delineation

To evaluate the sources contributing to Weeks Bay and represent their spatial variability in the watershed model, the contributing drainage area was represented by a series of subwatersheds. The watershed model developed for Mobile Bay (Tetra Tech 2012) was used for this project. The subwatersheds were developed using the U.S. Geological Survey National Hydrography Dataset (USGS/NHD). The entire Mobile Bay watershed was delineated into 242 subwatersheds (Figure 4), each of which were delineated using the National Elevation Dataset (NED) in one-third-arc-second resolution, USGS flow gage stations, Alabama Department of Environmental Management (ADEM) water quality monitoring stations, and other points of interest. Out of the 242 subwatersheds, 12 represent the Fish River and three represent the Magnolia River; their combined area represents the freshwater drainage to Weeks Bay. The LSPC model was simulated for the 8-year period from January 1, 2003, through December 31, 2011.

#### 3.2 Soils

Soil data for the Weeks Bay watershed was obtained from the Soil Survey Geographic Database (SSURGO). The database was produced and distributed by the Natural Resources Conservation Service (NRCS) – National Cartography and Geospatial Center. The SSURGO data were used to determine the total area that each hydrologic soil group covers in each subwatershed. The subwatersheds are represented by the hydrologic soil group that has the highest percentage of coverage within the boundaries of the subwatershed. Three soil groups are in the Weeks Bay watershed:

- *Group A Soils* have high infiltration rates and consist of soils that are deep and well drained to excessively drained and are often sandy with coarse textures.
- *Group B Soils* have moderate infiltration rates when wet and consist chiefly of soils that are moderately deep to deep, moderately well to well drained, and moderately fine to moderately coarse textures.
- *Group D Soils* have very slow infiltration rates and have soils that are clayey and impede downward movement of water, or can be shallow soils over an impervious layer. Soils have a high water table.

For Weeks Bay, both the Fish and Magnolia River watersheds are dominated by Group B soils.

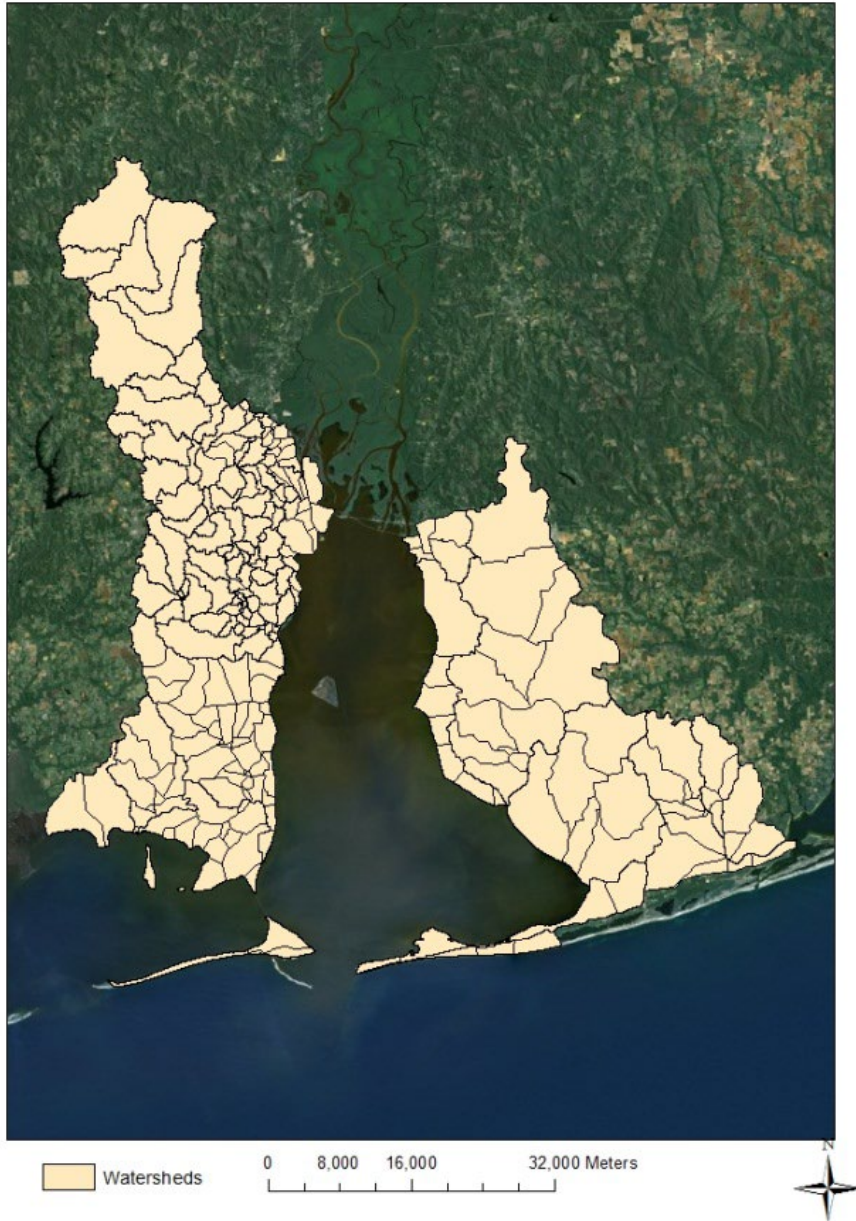

Figure 4. Delineation of the lateral watersheds draining to Mobile Bay, Alabama.

### 3.3 Meteorological Data

Nonpoint source loadings and hydrological conditions are dependent on weather conditions. Hourly data from weather stations within the boundaries of or close to the subwatersheds were applied to the watershed model. A weather data forcing file was generated in ASCII format (\*.air) for each meteorological station used in the hydrological evaluations in LSPC. Each meteorological station file contained atmospheric data used in modeling the hydrological processes. These data included precipitation, air temperature, dew point temperature, wind speed, cloud cover, evaporation, and solar radiation. All data were used directly or were calculated from the observed data from the National Oceanic and Atmospheric Administration (NOAA) National Climatic Data Center at the Mobile Regional Airport.

### 3.4 Reach Characteristics

The LSPC model must have a representative reach defined for each subwatershed. The channel mainstem in each subwatershed was used as the representative reach. The characteristics for each reach are reach length and slope, channel geometry, and connectivity between the subwatersheds. Length and slope data for each reach were obtained using the NED and NHD.

LSPC takes the attributes supplied for each reach and develops a function table (FTABLE). The FTABLE describes the hydrology of a river reach or reservoir segment by defining the functional relationship between water depth, surface area, water volume, and outflow in the segment. The assumption of a fixed depth, area, volume, and outflow relationship rules out cases where the flow reverses direction or where one reach influences another upstream reach in a time-dependent way. The routing technique falls in the class known as *storage routing* or *kinematic wave* methods for which momentum is not considered. Low-lying subwatersheds adjacent or immediately upstream of the estuary might be tidally influenced. LSPC does not model the tidal flow in the low-lying areas, and therefore the model was calibrated to USGS gages that are non-tidally, or nearly non-tidally, influenced.

### 3.5 Land Use Representation

The watershed model uses land use data as the basis for representing hydrology and nonpoint source loadings. Land use data were obtained from the Multi-Resolution Land Characteristics Consortium – National Land Cover Database (Fry et al. 2006), and included the following 15 land use class categories: open water, developed open space, developed low intensity, developed medium intensity, developed high intensity, barren, deciduous forest, evergreen forest, mixed forest, shrub/scrub, grassland/herbaceous, pasture/hay, cultivated crops, woody wetlands and emergent herbaceous wetlands. The NLCD coverage represented conditions in 2006. For the LSPC simulation, similar land use classes were grouped into reduced modeling units (RMUs). For example, deciduous forest, evergreen forest and mixed forest were grouped into an RMU called forest.

The LSPC model requires division of land uses in each subwatershed into separate pervious and impervious land units. For this, percent imperviousness was assigned to the urban land uses. Any impervious areas associated with developed open space and developed low intensity, were grouped and placed into a new RMU for low intensity development impervious. Impervious areas associated with medium intensity development and high intensity development were kept separate and placed into two new RMUs for medium intensity development impervious and high intensity development impervious, respectively. Finally, any impervious area not already accounted for in the three developed impervious RMUs, were grouped into a fourth new RMU called *All Other Impervious*. The distribution of land use types in the Weeks Bay watershed are shown in Table 1.

**Table 1. Distribution of land use types in the Weeks Bay watershed**

RMU land use category	RMU land use code	Original NLCD classification	NLCD land use code	Area (acres)	Area (%)
Water	2	11	Open Water	1,998.1	1.5%
LowIntDevPerv	3	21	Developed, Open Space	10,090.8	7.5%
LowIntDevPerv	3	22	Developed, Low Intensity	2,767.4	2.1%
LowIntDevImperv	4	222	20+21+22 Imperv	997.0	0.7%
MedIntDevPerv	5	231	Developed, Medium Intensity	393.6	0.3%
MedIntDevImperv	6	232	Developed, Medium Intensity	465.3	0.3%
HighIntDevPerv	7	241	Developed, High Intensity	40.8	0.0%
HighIntDevImperv	8	242	Developed, High Intensity	220.8	0.2%
Barren	9	31	Clearcut/Sparse	528.3	0.4%
Barren	9	33	Quarries/Strip Mines	0.0	0.0%
Forest	10	41	Deciduous Forest	20.5	0.0%
Forest	10	42	Evergreen Forest	23,939.8	17.8%
Forest	10	43	Mixed Forest	676.5	0.5%
Forest	10	52	Deciduous Shrubland	5,136.4	3.8%
Grassland	11	71	Grassland	7,398.0	5.5%
Pasture	12	81	Pasture	26,668.3	19.8%
Crop	13	82	Row Crop	32,827.1	24.4%
Wetland	14	90	Forested Wetland	18,782.5	14.0%
Wetland	14	95	Emergent Herbaceous Wetlands	1,678.2	1.2%
AllOtherImperv	15	332	Remaining Imperv	6.7	0.0%

Source: Fry et al. 2006

### 3.6 Point Source Discharges

A total of two industrial and two municipal dischargers were considered in the LSPC (Table 2). Both flow and concentration data were input to the model simulation. Discharge monitoring reports were provided by ADEM (Jason Wilkins, ADEM, September 21 and October 29, 2012, personal communication). ADEM generally provided monthly data for flow and nutrients as required by their permits. If monthly data were not provided, permit values were used.

**Table 2. Point source discharges in Weeks Bay watershed model**

NPDES ID	Facility name	Facility type	Subwatershed
AL0042234	Spanish Fort Sewer WWTP	Municipal	812
AL0060283	Loxley Lagoon	Municipal	810
AL0064866	Everwood Treatment Company	Industrial	812
AL0069345	Baldwin Country Solid Waste	Industrial	806

## 4 Weeks Bay Hydrodynamic and Water Quality Model Setup

### 4.1 Model Segmentation

The orthogonal, curvilinear grid system used in the hydrodynamic model (Figure 5) consisted of 437 horizontal cells and three equally spaced vertical  $\sigma$ -layers. There are 23 offshore boundary cells and two inland boundary cells, corresponding to the two river discharges. The bathymetry for Weeks Bay downloaded from NOAA National Geographic Data Center is shown in Figure 6.

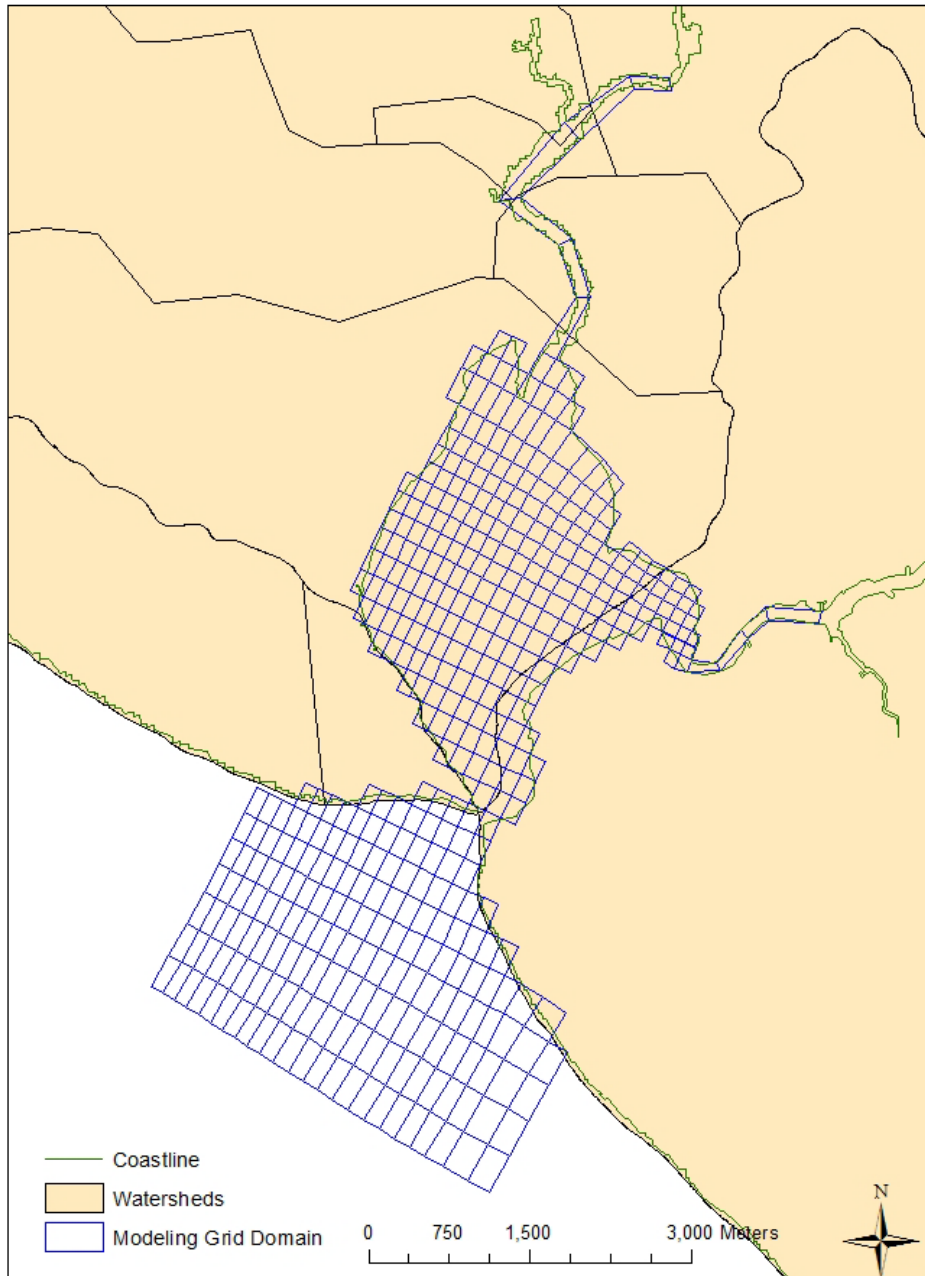
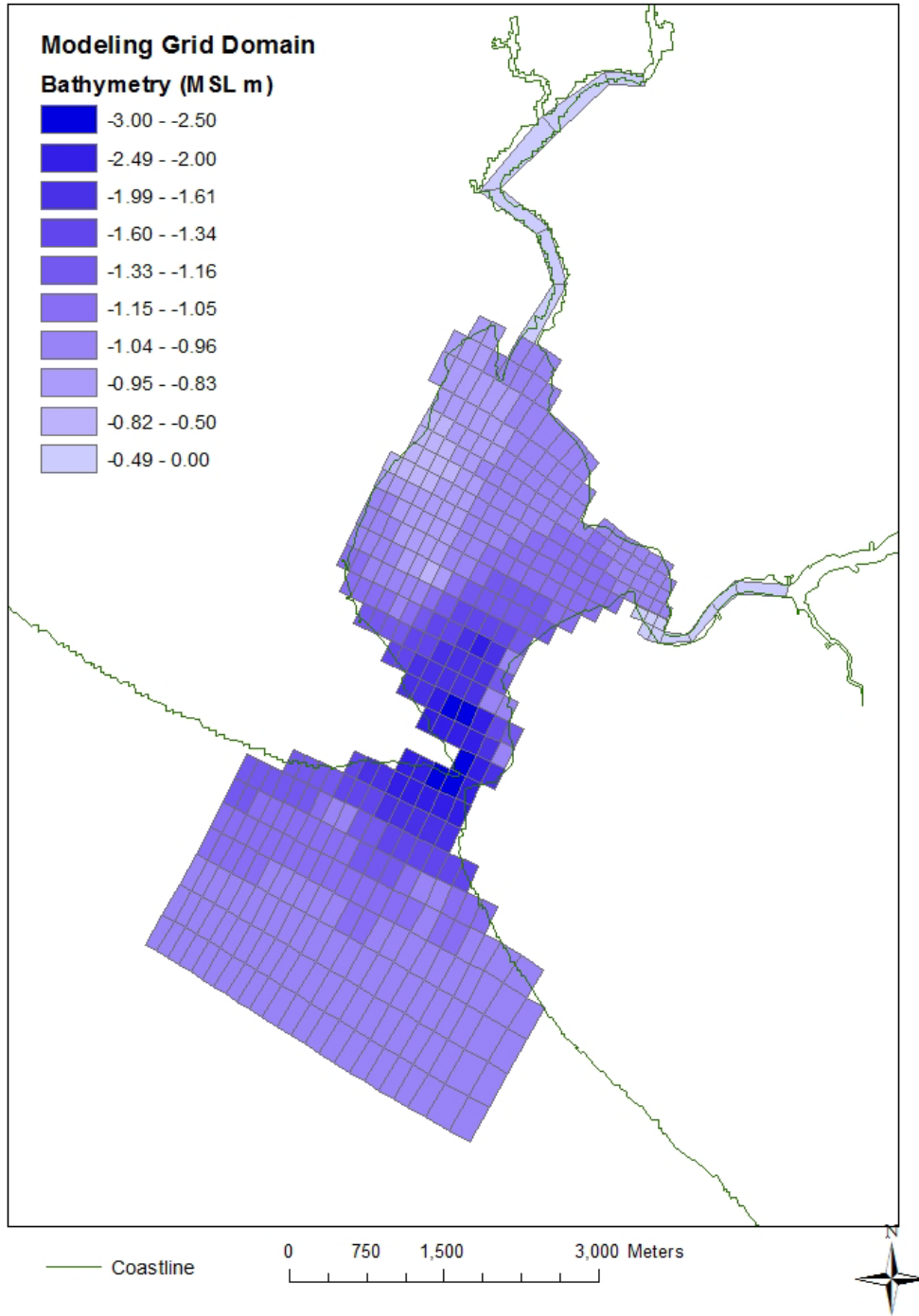

Figure 5. Orthogonal curvilinear grid of Weeks Bay.





Source: NOAA National Geographic Data Center

**Figure 6. Weeks Bay bathymetry.**

## 4.2 Weeks Bay Monitoring Data for Calibration

The calibration-validation process for Weeks Bay model used data collected by NOAA, National Estuarine Research Reserve System (NERRS) and ADEM. The locations of the corresponding monitoring stations in Weeks Bay are shown in Figure 7.

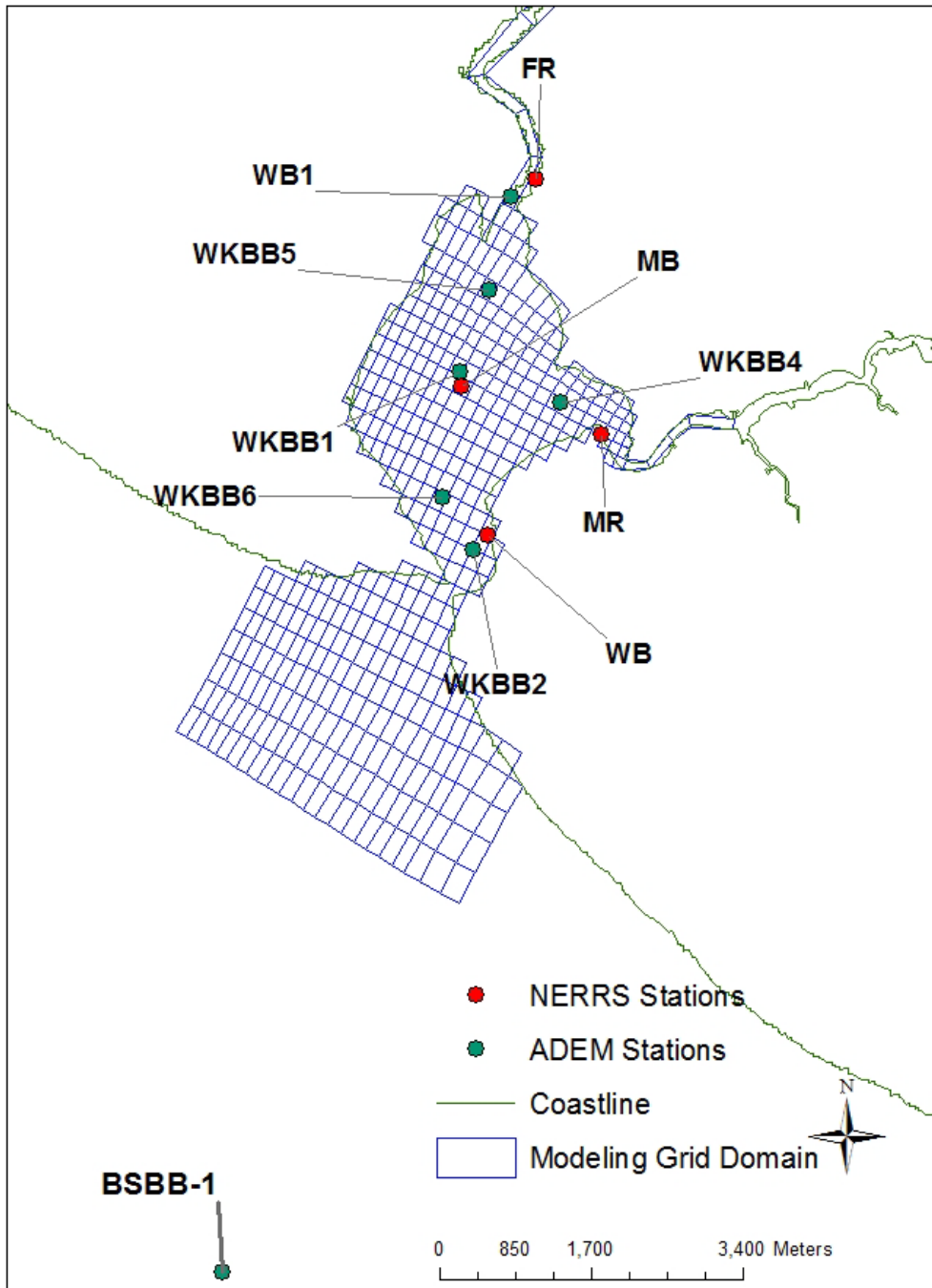

Note: Stations labeled as ADEM were sampled as part of this project (Appendix A [GOMA 2013]).

**Figure 7. Monitoring stations in Weeks Bay.**

For calibrating water surface elevation, salinity, and temperature, data from NOAA’s Dauphin Island, AL 8735180 tidal station were used

([http://tidesandcurrents.noaa.gov/station\\_info.shtml?stn=8735180+Dauphin+Island+,+AL](http://tidesandcurrents.noaa.gov/station_info.shtml?stn=8735180+Dauphin+Island+,+AL)). NOAA NERRS collected continuous data at four stations (WB, NB, FR and MR) for salinity, temperature, chlorophyll *a*, N-NH<sub>3</sub>, N-NO<sub>3</sub>, P-PO<sub>4</sub>, DO and depths for 2008–2011 (<http://cdmo.baruch.sc.edu/>) (Table 3). ADEM collected monthly samples of water quality nutrients, DO, salinity and conductivity for February–November 2011 (Table 4). In addition to monthly sampling, four intensive episodic nutrient surveys were conducted for the five mid-bay stations on April 17–20, June 13–17, July 5–8, and September 19–23. During these events, continuous sonde monitoring of water quality parameters was conducted. All 2011 monitoring data were collected and reported as part of this study (GOMA 2013).

**Table 3. Summary of data collected by NERRS**

Station_ID	PCode	Units	Number of observations	Average value	Minimum date	Maximum date
FR	CHL_A	µg/L	1,181	33.10	3/26/2002	11/15/2011
FR	DEPTH	m	250,460	2.13	1/1/2002	12/31/2011
FR	DO	mg/L	240,378	6.91	1/1/2002	12/31/2011
FR	N-NH3	mg/L	1,005	0.07	3/26/2002	12/15/2011
FR	N-NO3	mg/L	1,227	0.44	2/13/2002	12/15/2011
FR	P-PO4	mg/L	1,238	0.00	2/13/2002	12/15/2011
FR	SALINITY	PSU	252,006	7.56	1/1/2002	12/31/2011
FR	TEMP	degC	252,722	22.45	1/1/2002	12/31/2011
MR	CHL_A	µg/L	301	35.54	5/14/2002	11/15/2011
MR	DEPTH	m	216,684	1.26	5/5/2003	12/31/2011
MR	DO	mg/L	214,350	7.35	5/5/2003	12/31/2011
MR	N-NH3	mg/L	251	0.06	4/20/2002	12/15/2011
MR	N-NO3	mg/L	320	0.44	2/13/2002	12/15/2011
MR	P-PO4	mg/L	318	0.01	2/13/2002	12/15/2011
MR	SALINITY	PSU	220,179	9.69	5/5/2003	12/31/2011
MR	TEMP	degC	220,482	22.91	5/5/2003	12/31/2011
MB	DEPTH	m	11,943	0.85	5/5/2003	11/28/2011
MB	DO	mg/L	11,455	7.30	5/5/2003	11/28/2011
MB	SALINITY	PSU	11,897	10.04	5/5/2003	11/28/2011
MB	TEMP	degC	11,943	22.77	5/5/2003	11/28/2011
WB	CHL_A	µg/L	28,309	61.64	3/26/2002	12/31/2011
WB	DEPTH	m	41,278	0.70	1/1/2002	12/31/2011
WB	DO	mg/L	39,733	7.39	1/1/2002	12/31/2011
WB	N-NH3	mg/L	250	0.06	3/26/2002	12/15/2011
WB	N-NO3	mg/L	317	0.14	2/13/2002	12/15/2011
WB	P-PO4	mg/L	315	0.01	2/13/2002	12/15/2011
WB	SALINITY	PSU	41,688	11.12	1/1/2002	12/31/2011
WB	TEMP	degC	41,752	22.64	1/1/2002	12/31/2011

Source: <http://cdmo.baruch.sc.edu/>

**Table 4. Summary of monitoring data collected as part of this study**

Station_ID	PCode	Units	Number of observations	Average value	Minimum date	Maximum date
WKBB-1	BOD5	mg/L	18	4.24	2/23/2011	11/9/2011
WKBB-1	CHL_A	µg/L	18	9.17	2/23/2011	11/9/2011
WKBB-1	DEPTH	m	44	1.22	2/23/2011	11/9/2011
WKBB-1	DO	mg/L	71	7.84	2/23/2011	11/9/2011
WKBB-1	DOC	mg/L	17	3.21	2/23/2011	11/9/2011
WKBB-1	DRP	mg/L	18	0.01	2/23/2011	11/9/2011
WKBB-1	N-NH3	mg/L	18	0.02	2/23/2011	11/9/2011
WKBB-1	N-NO3	mg/L	18	0.04	2/23/2011	11/9/2011
WKBB-1	SALINITY	PSU	71	8.56	2/23/2011	11/9/2011
WKBB-1	TKN	mg/L	18	1.34	2/23/2011	11/9/2011
WKBB-1	TOC	mg/L	18	3.95	2/23/2011	11/9/2011
WKBB-1	TP	mg/L	18	0.08	2/23/2011	11/9/2011
WKBB-1	TSS	mg/L	18	28.17	2/23/2011	11/9/2011
WKBB-2	BOD5	mg/L	18	3.74	2/22/2011	11/8/2011
WKBB-2	CHL_A	µg/L	18	7.04	2/22/2011	11/8/2011
WKBB-2	DEPTH	m	46	4.28	2/22/2011	11/8/2011
WKBB-2	DO	mg/L	150	7.20	2/22/2011	11/8/2011
WKBB-2	DOC	mg/L	18	3.09	2/22/2011	11/8/2011
WKBB-2	DRP	mg/L	18	0.01	2/22/2011	11/8/2011
WKBB-2	N-NH3	mg/L	18	0.03	2/22/2011	11/8/2011
WKBB-2	N-NO3	mg/L	18	0.08	2/22/2011	11/8/2011
WKBB-2	SALINITY	PSU	150	11.03	2/22/2011	11/8/2011
WKBB-2	TKN	mg/L	18	1.10	2/22/2011	11/8/2011
WKBB-2	TOC	mg/L	18	3.85	2/22/2011	11/8/2011
WKBB-2	TP	mg/L	18	0.08	2/22/2011	11/8/2011
WKBB-2	TSS	mg/L	18	28.94	2/22/2011	11/8/2011
WKBB-4	BOD5	mg/L	18	4.37	2/22/2011	11/8/2011
WKBB-4	CHL_A	µg/L	18	9.63	2/22/2011	11/8/2011
WKBB-4	DEPTH	m	44	1.04	2/22/2011	11/8/2011
WKBB-4	DO	mg/L	67	8.54	2/22/2011	11/8/2011
WKBB-4	DOC	mg/L	17	3.30	2/22/2011	11/8/2011
WKBB-4	DRP	mg/L	18	0.01	2/22/2011	11/8/2011
WKBB-4	N-NH3	mg/L	18	0.03	2/22/2011	11/8/2011
WKBB-4	N-NO3	mg/L	18	0.03	2/22/2011	11/8/2011
WKBB-4	SALINITY	PSU	67	8.79	2/22/2011	11/8/2011
WKBB-4	TKN	mg/L	18	1.27	2/22/2011	11/8/2011
WKBB-4	TOC	mg/L	18	3.90	2/22/2011	11/8/2011
WKBB-4	TP	mg/L	18	0.08	2/22/2011	11/8/2011
WKBB-4	TSS	mg/L	18	24.06	2/22/2011	11/8/2011
WKBB-5	BOD5	mg/L	18	4.28	2/23/2011	11/9/2011
WKBB-5	CHL_A	µg/L	18	9.01	2/23/2011	11/9/2011
WKBB-5	DEPTH	m	44	0.96	2/23/2011	11/9/2011
WKBB-5	DO	mg/L	66	8.54	2/23/2011	11/9/2011
WKBB-5	DOC	mg/L	18	3.24	2/23/2011	11/9/2011

*Sources, Fate, Transport, and Effects (SFTE) of Nutrients as a Basis for Protective Criteria  
in Estuarine and Near Coastal Waters: Modeling Results*

<b>Station_ID</b>	<b>PCode</b>	<b>Units</b>	<b>Number of observations</b>	<b>Average value</b>	<b>Minimum date</b>	<b>Maximum date</b>
WKBB-5	DRP	mg/L	18	0.01	2/23/2011	11/9/2011
WKBB-5	N-NH3	mg/L	18	0.03	2/23/2011	11/9/2011
WKBB-5	N-NO3	mg/L	18	0.06	2/23/2011	11/9/2011
WKBB-5	SALINITY	PSU	66	6.72	2/23/2011	11/9/2011
WKBB-5	TKN	mg/L	18	1.21	2/23/2011	11/9/2011
WKBB-5	TOC	mg/L	18	3.99	2/23/2011	11/9/2011
WKBB-5	TP	mg/L	18	0.07	2/23/2011	11/9/2011
WKBB-5	TSS	mg/L	18	22.67	2/23/2011	11/9/2011
WKBB-6	BOD5	mg/L	18	3.37	2/22/2011	11/8/2011
WKBB-6	CHL_A	µg/L	18	10.10	2/22/2011	11/8/2011
WKBB-6	DEPTH	m	44	1.36	2/22/2011	11/8/2011
WKBB-6	DO	mg/L	73	8.10	2/22/2011	11/8/2011
WKBB-6	DOC	mg/L	18	3.18	2/22/2011	11/8/2011
WKBB-6	DRP	mg/L	18	0.01	2/22/2011	11/8/2011
WKBB-6	N-NH3	mg/L	18	0.07	2/22/2011	11/8/2011
WKBB-6	N-NO3	mg/L	18	0.04	2/22/2011	11/8/2011
WKBB-6	SALINITY	PSU	73	9.96	2/22/2011	11/8/2011
WKBB-6	TKN	mg/L	18	1.16	2/22/2011	11/8/2011
WKBB-6	TOC	mg/L	17	3.81	2/22/2011	11/8/2011
WKBB-6	TP	mg/L	18	0.08	2/22/2011	11/8/2011
WKBB-6	TSS	mg/L	18	27.28	2/22/2011	11/8/2011
BSBB-1	BOD5	mg/L	10	3.19	2/22/2011	11/8/2011
BSBB-1	CHL_A	µg/L	10	4.57	2/22/2011	11/8/2011
BSBB-1	DEPTH	m	44	1.60	2/22/2011	11/8/2011
BSBB-1	DO	mg/L	66	7.36	2/22/2011	11/8/2011
BSBB-1	DOC	mg/L	9	2.87	2/22/2011	11/8/2011
BSBB-1	DRP	mg/L	10	0.01	2/22/2011	11/8/2011
BSBB-1	N-NH3	mg/L	10	0.04	2/22/2011	11/8/2011
BSBB-1	N-NO3	mg/L	10	0.06	2/22/2011	11/8/2011
BSBB-1	SALINITY	PSU	66	12.20	2/22/2011	11/8/2011
BSBB-1	TKN	mg/L	10	1.31	2/22/2011	11/8/2011
BSBB-1	TOC	mg/L	10	3.25	2/22/2011	11/8/2011
BSBB-1	TP	mg/L	10	0.08	2/22/2011	11/8/2011
BSBB-1	TSS	mg/L	10	37.60	2/22/2011	11/8/2011

Source: GOMA 2013

### 4.3 Hydrodynamic Model Forcing Conditions

The purpose of the EFDC hydrodynamic modeling was to reproduce the three-dimensional circulation, salinity, and temperature dynamics in the bay system. The model predicts these parameters in response to a set of multiple factors: wind speed and direction, freshwater discharge, tidal water level fluctuation, rainfall, surface heat flux, and temperature and salinity associated with boundary fluxes.

Hourly measurements of atmospheric pressure, dry and wet bulb atmospheric temperatures, rainfall rate, wind speed and direction, and fractional cloud cover were obtained from data collected at station WBAN 13894, Mobile Regional Airport for 2008–2011. Solar short wave radiation was calculated using the CE-QualW2 method (Cole and Wells 2006).

The major sources of freshwater input include the Fish and Magnolia Rivers. Flow and temperature data were downloaded from USGS gages 02378300 (Mobile River) and 02378500 (Fish River) (<http://waterdata.usgs.gov/nwis>).

All major point sources are included in the LSPC model setup.

Hourly water surface elevation (WSE) data measured at NOAA tidal station 8735180, Dauphin Island, were initially used as boundary conditions at the offshore open boundary. These boundary conditions were adjusted during the WSE calibration by comparing observed data with WSE measurements at the NERRS and ADEM Weeks Bay stations. Daily temperature and salinity data observed at NOAA tidal station 8735180, Dauphin Island, were initially used as boundary conditions at the offshore boundary. These boundary conditions were adjusted during the salinity and temperature calibration by comparing observed data with the simulations at location of the Weeks Bay monitoring stations.

### 4.4 Water Quality Model Forcing Conditions

The purpose of the WASP7 water quality modeling was to reproduce the three-dimensional transport and chemical and biological interactions of major components of water quality in the Weeks Bay. Fourteen such components were selected:

- Chlorophyll *a*
- Nitrate+nitrite nitrogen (N-NO<sub>x</sub>)
- Ammonia nitrogen (N-NH<sub>4</sub>)
- Dissolved organic nitrogen (ON)
- Detrital nitrogen (DN)
- Orthophosphate (P-PO<sub>4</sub>)
- Organic phosphorus (OP)
- Detrital phosphorus (DP)
- Carbonaceous biochemical oxygen demand 1 (CBOD<sub>1</sub>)
- Carbonaceous biochemical oxygen demand 2 (CBOD<sub>2</sub>)
- Carbonaceous biochemical oxygen demand 3 (CBOD<sub>3</sub>)
- Detrital carbon (DC)
- Dissolved oxygen (DO)
- Total suspended solids (TSS)

The model predicts these parameters in response to a set of hydrologic, meteorological, atmospheric, chemical, and biological factors: loads from point and nonpoint sources, sediment oxygen demand (SOD), solar radiation, air temperature, atmospheric aeration, offshore and inland boundary conditions.

Data for these elements were derived in the following manner:

- Point and nonpoint sources were simulated by the LSPC model. The outputs of the simulations were used as the river boundary conditions for the Weeks Bay WASP7 model.
- Meteorological data for WASP7 was the same as presented for the EFDC model setup.
- SOD values were initially selected using observations and analysis presented in the *Weeks Bay Water Quality Study* report (USEPA 2011). The SOD values were adjusted during the DO calibration process.
- Atmospheric aeration in WASP was calculated using the O'Connor-Dobbins option.
- Time series of watershed load concentrations were obtained from LSPC simulations for TSS, CBOD and DO. Time series of concentrations of dissolved nutrients were obtained from NERRS monitoring stations – Magnolia River (Lat Long: 30° 23' 24.00 N - 87° 49' 3.72 W) and Fish River (Lat Long: 30° 24' 58.32 N - 87° 49' 22.08 W). Chlorophyll *a* concentrations in point sources discharges were assumed to be 0 mg/L.
- Chlorophyll *a* concentrations in Magnolia and Fish rivers were selected on the basis of NERRS monitoring data. 2011 monitoring data for station BSBB-1 (Bon Secour Bay) were used for defining the offshore water quality boundary conditions. Chlorophyll *a* concentrations on offshore boundary were selected as 2 mg/L. The inland and offshore boundary conditions for detrital components of the model were assumed to be 0 mg/L.

Final calibration values for chemical and biological constants of the water quality model are presented in Table 5. All forcing functions, boundary conditions, calibration rates and constants are included in the WASP7 input file (1-08M-EXI.WIF).

**Table 5. Rates and coefficients for Weeks Bay water quality model**

WASP variable	Definition	Value
Phytoplankton	Maximum Growth Rate Constant at 20 °C (per day)	2.9
	Growth Temperature Coefficient	1.07
	Self Shading Extinction (Dick Smith Formulation)	0.017
	Carbon to Chlorophyll Ratio	60
	Half-Saturation Constant for Nitrogen Uptake (mg N/L)	0.025
	Half-Saturation Constant for Phosphorus Uptake (mg P/L)	0.001
	Endogenous Respiration Rate Constant at 20 °C (per day)	0.05
	Respiration Temperature Coefficient	1.022
	Phosphorus to Carbon Ratio	0.016
	Nitrogen to Carbon Ratio	0.15
	Half-Sat. for Recycle of Nitrogen and Phosphorus (mg Phyt C/L)	0.005
N-NH <sub>3</sub>	Nitrification Rate Constant at 20 °C (per day)	0.01
	Nitrification Temperature Coefficient	1.08
	Half Saturation Constant for Nitrification Oxygen Limit (mg O/L)	0.5
N-NO <sub>3</sub>	Denitrification Rate Constant at 20 °C (per day)	0.09
	Denitrification Temperature Coefficient	1.045
	Half Saturation Constant for Denitrification Oxygen Limit (mg O/L)	0.01
ON	Dissolved Organic Nitrogen Mineralization Rate at 20 °C (per day)	0.1
	Dissolved Organic Nitrogen Mineralization Temperature Coefficient	1.047
	Fraction of Phytoplankton Death Recycled to Organic Nitrogen	0.95

<b>WASP variable</b>	<b>Definition</b>	<b>Value</b>
OP	Mineralization Rate for Dissolved Organic P at 20 °C (per day)	0.1
	Dissolved Organic Phosphorus Mineralization Temperature Coeff.	1.04
	Fraction of Phytoplankton Death Recycled to Organic Phosphorus	0.95
Light	Light Option (1 uses input light; 2 uses calculated diel light)	2
	Phytoplankton Maximum Quantum Yield Constant	720
	Phytoplankton Optimal Light Saturation	350
	Detritus and Solids Light Extinction Multiplier	0.002
	DOC Light Extinction Multiplier	0.4
DO	Waterbody Type Used for Wind Driven Reaeration Rate	2
	Calc Reaeration Option - O'Connor	1
	Reaeration Option -Sums Wind and Hydraulic Ka	1
	Theta -- Reaeration Temperature Correction	1.022
	Oxygen to Carbon Stoichiometric Ratio	2.66
CBOD <sub>2</sub> CBOD <sub>3</sub>	BOD Decay Rate Constant at 20 °C (per day)	0.02
	BOD Decay Rate Temperature Correction Coefficient	1.04
	BOD Half Saturation Oxygen Limit (mg O/L)	0.2
CBOD <sub>1</sub>	BOD Decay Rate Constant at 20 °C (per day)	0
	BOD Decay Rate Temperature Correction Coefficient	0
	BOD Half Saturation Oxygen Limit (mg O/L)	0
Detritus	Detritus Dissolution Rate (1/day)	0.1
	Temperature Correction for detritus dissolution	1.08



## 5 Weeks Bay Model Calibration and Validation

Calibration and validation were necessary and critical steps in developing the Weeks Bay model. Model performance, i.e., the ability to reproduce field observations, was evaluated through qualitative and quantitative analyses involving both graphical comparisons and statistical tests.

The Weeks Bay model calibration was a hierarchical process beginning with WSE calibration, which is based on hourly measurements from the appropriate tidal station. WSE was the major forcing factor of water dynamics in the bay. The next step of calibration involved salinity and water temperature dynamics. Acceptable graphical and statistical comparisons with observed data allowed validation of the EFDC hydrodynamic model by comparisons with independent data (different monitoring stations' locations, or periods of observation, or both).

The calibrated EFDC model produced dynamic fields of velocity, water temperature, salinity and volume of grid cells for use in water quality model (WASP7) calibration and validation. WASP7 calibration includes selection of values of numerous biological and chemical parameters that populate mathematical equations that describe chemical and biological transformation of model constituents.

Table 6 presents the rating system which was used for determining the overall success of calibration-validation process for the hydrodynamics and water quality models for Weeks Bay. The rating system is based on EPA's technical guidance for model applications (Donigian 2000; McCutcheon et al. 1990). The rating categories provide a general guidance in terms of the percent mean differences between simulated and observed values for the different state variables.

**Table 6. General calibration/validation targets for EFDC/WASP7 applications**

State variable	% Difference between simulated and observed values		
	Very good	Good	Fair
Salinity	< 15%	15%–25%	25%–40%
Water Temperature	< 7%	8%–12%	13%–18%
Water quality/D.O.	< 15%	15%–25%	25%–35%
Nutrients/Chl a	< 30%	30%–45%	45%–60%

### 5.1 Hydrodynamic Model Calibration and Validation Analysis

Results of calibration and validation of the hydrodynamic components of the Weeks Bay model are presented in Appendix A. Year 2008 measurements of salinity, water temperature and depth dynamics at NERRS stations Mid-Bay, Weeks Bay, Magnolia and Fish River were selected as a calibration data set. Monitoring data for 2009–2011 at the same NERRS stations and 2011 ADEM data for stations WB1, WKBB1, WKBB2, WKBB4, WKBB5 and WKBB6 (Figure 7) were used for validation purposes. The original numerical and visual comparisons of simulated and measured values are discussed in Appendix A. The summary of salinity and water temperature simulation-measurement comparisons are presented in Table 7.

**Table 7. Quality of salinity and temperature calibration of Weeks Bay model**

Station	Salinity	Temperature
MB	Very Good	Very Good
WB1	Very Good	Very Good
MR	Fair	Very Good
FR	Very Good	Very Good
WB1	Very Good	No Observations
WKBB1	Very Good	Very Good
WKBB2	Fair	No Observations
WKBB4	Very Good	No Observations
WKBB5	Very Good	Very Good
WKBB6	Fair	Very Good

The relative depth dynamics do not have evaluation grades in Table 6. So the model performance was evaluated on the basis of results presented in Table 8 (from Appendix A).

**Table 8. Comparison of simulated and measured depth dynamics at NERRS monitoring stations**

Station	Simulations (m)	Measurements (m)	Deviation (%)
	Mean	Mean	
Mid-Bay	1.18	1.1	7%
Weeks Bay	1.13	1.25	-10%
Magnolia River	1.77	1.66	7%
Fish River	3.21	3.13	3%

Table 8 shows that the difference of means between observed and simulated oscillations of depth values are in the range of 7–12 cm with a deviation of 3–10 percent in relation to measured depth. The results of salinity and temperature calibration (Table 7) and depth dynamics calibration (Table 8) provide an estimate of the quality of the hydrodynamic model performance.

## 5.2 Water Quality Calibration and Validation Analysis

Results of calibration and validation of water quality components of the Weeks Bay model are presented in Appendix B. Year 2008 measurements of chlorophyll *a*, mineral nitrogen and phosphorus, DO, CBOD, and TSS at NERRS stations MB, WB, MR and FR were selected as a calibration data set. Monitoring data for 2009–2011 at the same NERRS stations and 2011 ADEM data for stations WB1, WKBB1, WKBB2, WKBB4, WKBB5 and WKBB6 (Figure 7) were used for validation purposes. The original numerical and visual comparisons of simulated and measured values are discussed in Appendix B.

The figures in Appendix B present simulated and measured water quality constituent dynamics in surface and bottom layers of the Weeks Bay model. Comparing means of simulated and measured variables with the general quality targets of Table 6 allows conclusions to be made about success of the calibration-validation procedure. A summary of the water quality calibration and validation results is presented in Table 9.

**Table 9. Quality of calibration and validation of Weeks Bay water quality model**

WASP variable	Station	Grade	WASP variable	Station	Grade
Chlorophyll a	MB	Very Good	DO	MB	Very Good
	WB	Very Good		WB	Very Good
	MR	Very Good		MR	Very Good
	FR	Very Good		FR	Good
Mineral nitrogen	MB	Good		WB1	Very Good
	WB	Good		WKBB1	Very Good
	MR	Very Good		WKBB2	Very Good
	FR	Good		WKBB4	Very Good
	WB1	Fair		WKBB5	Good
	WKBB1	Fair		WKBB6	Very Good
	WKBB2	Very Good	CBOD	WB1	Good
	WKBB4	Poor		WKBB1	Very Good
	WKBB5	Very Good		WKBB2	Very Good
	WKBB6	Fair		WKBB4	Good
Mineral TP	MB	Very Good		WKBB5	Very Good
	WB	Very Good		WKBB6	Good
	MR	Very Good	TSS	WB1	Very Good
	FR	Very Good		WKBB1	Very Good
	WB1	Very Good		WKBB2	Very Good
	WKBB1	Very Good		WKBB4	Very Good
	WKBB2	Very Good		WKBB5	Very Good
	WKBB4	Very Good		WKBB6	Very Good
	WKBB5	Very Good			
	WKBB6	Very Good			

Table 9 presents mostly Good and Very Good estimates of quality of Weeks Bay water quality model performance. Three Fair and one Poor grades were calculated for the mineral nitrogen simulations. These calibration results demonstrate that the Weeks Bay water quality model is acceptable for use in developing numeric nutrient criteria.

Appendix C contains figures depicting the spatial distribution of the 50<sup>th</sup> percentile of major simulated water quality constituents in Weeks Bay. The figures help with the detailed understanding of median values of the bay’s water ecosystem components distributions that were formed in simulation years 2008–2011. The similar figures can be created for higher and lower percentiles that allow estimating of ranges of the models components dynamics.

The median value distributions show that the simulated surface chlorophyll *a* concentrations in Fish and Magnolia Rivers are low in comparison to the mid-bay area. TN and TP concentrations are highest in Fish and Magnolia Rivers. These concentrations are diluted by low nutrient concentration marine waters. CBOD concentrations are highest in Magnolia River. TSS concentrations are lowest in streams and increase in the bay because of mixing between freshwater and marine waters. TSS is highest in Mobile Bay itself. Salinity behaves similarly to TSS. It is lowest in streams and highest on Weeks Bay open boundaries. Surface DO shows the distribution that is close to uniform. The reason is the strong atmospheric source of oxygen (reaeration effect). Bottom DO shows the significant spatial differences that are caused by the depth, salinity, and SOD horizontal distributions. The lowest concentrations of the

bottom DO are in the deepest part of the modeled area (mouth of Fish River). The simulated distribution of light extinction coefficient can be used to identify areas of the bay that are favorable for benthic organisms. The highest light extinction coefficient was simulated in central parts of Weeks Bay. This indicates unfavorable conditions for submerged aquatic vegetation, and is in agreement with results presented in Miller-Way et. al (1996). They located only two small patches of bottom vegetation, less than an acre each, near the mouth of the bay and a small unnamed creek just inside the bay to the east.

## 6 Analysis of Nutrient Loading Scenarios

Initially, LSPC was run for two scenarios: existing conditions (S1) and non-anthropogenic conditions (S2). The existing conditions scenario presumably represents a nutrient load for the bay that is higher than desirable, and the non-anthropogenic scenario represents the lowest achievable load. S2 nutrient loads were reproduced in LSPC by simulating a non-anthropogenic condition in which all point sources of nutrients were set to zero and existing land use was converted to the forest and wetland land use. The existing and non-anthropogenic LSPC scenarios generate correspondent nutrient loads. The S2/S1 nutrient load ratios for Weeks Bay averaged over 2008–2011 are presented in Table 10.

**Table 10. S2 to S1 nutrient load ratios**

Rivers	N-NH <sub>4</sub>	N-NO <sub>x</sub>	ON	P-PO <sub>4</sub>	OP	TN	TP
Magnolia	0.63	0.63	0.63	0.37	0.37	0.63	0.37
Fish	0.5	0.5	0.5	0.25	0.25	0.5	0.25

The current simulation setup assumed that the boundary values of chlorophyll *a* and SOD are unchanged for all scenarios. The possible including of dependence of these parameters from the nutrient loads can significantly increase the sensitivity of the model to alternative loading scenarios.

The reduced load scenarios can be calculated using the formula

$$S3 = S2 + i \times (S1 - S2),$$

where *S3* is a reduced load scenario and *K* is a load reduction coefficient.

In the S3 scenario for Weeks Bay, *K* = 0.5 (50 percent reduction of anthropogenic part of the nutrient loads). The S3/S1 nutrient load ratios for these reductions are presented in Table 11.

**Table 11. S3 to S1 nutrient load ratios for 50 percent anthropogenic nutrient load reduction**

Rivers	N-NH <sub>4</sub>	N-NO <sub>x</sub>	ON	P-PO <sub>4</sub>	OP	TN	TP
Magnolia	0.815	0.815	0.815	0.685	0.685	0.815	0.685
Fish	0.75	0.75	0.75	0.625	0.625	0.75	0.625

For all scenarios, TSS and CBOD<sub>1</sub> remain the same as for S1.

## 6.1 Effect of Decreased Nutrient Loads on Primary Production

The primary production rate in Weeks Bay was calculated using WASP-simulated phytoplankton oxygen production and consumption parameters. The gross primary production values averaged annually over the volume of Weeks Bay are presented in Table 12 for each nutrient load scenario. These results are close to the  $160 \text{ g C m}^{-2} \text{ y}^{-1}$  primary production rate that was proposed as a typical value for coastal areas by Smith and Hollibaugh (1993).

Table 12 shows that by reducing the anthropogenic component of nutrient loads to zero, we can decrease the primary production by 27 percent (S2 versus S1); whereas a 50 percent decrease of the anthropogenic load reduces primary production by 12 percent (S3 versus S1).

**Table 12. Primary production rates in Weeks Bay**

Year	Nutrient load alternative scenarios					
	S1		S2		S3	
	$\text{O}_2 \text{ g m}^{-2} \text{ y}^{-1}$	$\text{C g m}^{-2} \text{ y}^{-1}$	$\text{O}_2 \text{ g m}^{-2} \text{ y}^{-1}$	$\text{C g m}^{-2} \text{ y}^{-1}$	$\text{O}_2 \text{ g m}^{-2} \text{ y}^{-1}$	$\text{C g m}^{-2} \text{ y}^{-1}$
2009	544.1	204.6	375.0	141.0	464.5	174.6
2010	440.2	165.5	323.9	121.8	387.2	145.5
2011	565.2	212.5	448.0	168.4	515.2	193.7
Average	516.5	194.2	382.3	143.7	455.6	171.3

Note: C = carbon;  $\text{O}_2$  = oxygen

## 6.2 Effect of Decreased Nutrient Loads on Chlorophyll *a*

The second endpoint used to derive numeric nutrient criteria can be based on phytoplankton biomass and preventing excessive nuisance algal blooms. EPA is applying a chlorophyll *a* endpoint that prevents concentrations above a specified value more than 10 percent of the time. Specifically, the modeled 90<sup>th</sup> percentile average daily concentration in the photic zone must be less than or equal to this specified value to be considered supporting designated uses. The average simulated depth of Weeks Bay was 0.68 m in 2008–2011. Table 13 shows that the photic zone is about 0.77 m. So, the photic zone covers the entire water column of the bay.

Water column chlorophyll *a* geometric mean values for the validation years 2009–2011 range from 26.1 to 29.3  $\mu\text{g/L}$  (Table 13). The results presented in the table demonstrate the moderate sensitivity of the Weeks Bay phytoplankton to nutrient loads.

**Table 13. Surface phytoplankton biomass (90<sup>th</sup> percentile) in Weeks Bay**

Year	Photic zone phytoplankton (Chl <i>a</i> $\mu\text{g/L}$ )		
	S1	S2	S3
2009	24.3	20.6	22.6
2010	20.6	18.4	19.7
2011	34.5	30.9	32.9
90th percentile	34.7	30.9	33.0

### 6.3 Effect of Decreased Nutrient Loads on Dissolved Oxygen

In addition to the chlorophyll *a* target, the water quality simulation model was also evaluated against a DO endpoint. In developing that endpoint, the existing Alabama DO criteria for aquatic life use were considered:

(iii) In estuaries and tidal tributaries, [DO] concentrations shall not be less than 5 mg/L, except in dystrophic waters or where natural conditions cause the value to be depressed.

(iv) In the application of [DO] criteria referred to above, [DO] shall be measured at a depth of 5 feet in waters 10 feet or greater in depth; and for those waters less than 10 feet in depth, [DO] criteria will be applied at mid-depth.

Weeks Bay is a shallow estuary with mean depth of less than 10 feet. The time series model output of DO concentrations in middle vertical layer (averaged over the bay) were evaluated relative to the Alabama DO criterion (Table 14), and illustrate that natural nutrient loadings concentrations do not improve the bay's oxygen regime.

**Table 14. Percent model exceedances of Alabama DO criterion under three scenarios**

Criterion	% of criteria violation		
	S1	S2	S3
Alabama	8.1	10.4	9.1

Decreases of phytoplankton biomass with the reduction of nutrient loadings lead to decreased oxygen production through photosynthesis and, thus, a small decrease of oxygen concentrations in the middle layer of the bay.

It is important to note as stated above that the current simulation setup assumed that the boundary values of chlorophyll *a* and SOD are unchanged for all scenarios. The possible including of dependence of these parameters from the nutrient loads can significantly increase the sensitivity of the model to alternative loading scenarios. So, SOD did not vary as a function of chlorophyll *a*/algal growth, which it might be expected to do. This seems to have affected the DO response as one would expect DO to increase as SOD decreases under reduced nutrient inputs (S2 and S3) and not decrease as it is shown. This effect could and likely should be incorporated into future versions.

### 6.4 Effect of Decreased Nutrient Loads on Water Clarity

Table 15 demonstrates the effect of nutrient load changes on the light extinction coefficient (*K<sub>d</sub>*). Different nutrient loading scenarios show a very small effect on clarity of the bay's water for each of the modeled years. But comparing the same scenario outputs for different years demonstrates significant differences that can be explained by only the stronger influences of TSS and CDOM (color) natural loads on light attenuation. The same results can be expressed as a change in compensation depth (depth at which light is 10% ambient) and as a change in the areal extent of depths with sufficient light to support SAV growth. That effort could also be included in future versions.

**Table 15. Changes in light extinction coefficient -  $K_d$  ( $m^{-1}$ ) and photic zones –PHZ (m) under three scenarios**

Year	Nutrient load alternative scenarios					
	S1		S2		S3	
	$K_d$	PHZ	$K_d$	PHZ	$K_d$	PHZ
2009	2.28	1	2.18	1.06	2.23	1.03
2010	3.01	0.76	2.95	0.78	2.98	0.77
2011	3.14	0.73	3.06	0.75	3.11	0.74
Average	2.81	0.83	2.73	0.86	2.77	0.85

Note:  $K_d$  = light extinction coefficient (1/meter); PHZ = photic zone (meters)

## 6.5 Numeric Nutrient Criteria

Mechanistic modeling can be used to support developing numeric nutrient criteria by determining the level of nutrient reductions required to meet endpoint targets. The scenarios evaluated in this report demonstrate the potential effects that nutrient reductions can have on response parameters. The response parameters that were evaluated (primary production, surface chlorophyll *a*, DO in the middle layer of the bay, and light attenuation) are metrics that can be used in association with the chlorophyll *a* and DO endpoints. Additional metrics should also be considered, along with their effects on proposed endpoints. Appropriately selected metrics will support selecting a load-reduction scenario that will achieve the desired water quality in Weeks Bay. When the same process of developing nutrient criteria is applied to other estuaries of the Gulf of Mexico, different metrics might be needed depending on regional conditions (such as the presence of sea grass), available data, and the expertise of researchers involved in the data analysis. Once a load reduction scenario is selected for an estuary, a standard methodology should be used for translating the scenario outputs into numeric nutrient criteria. A recommended methodology is to set the criteria at the 90<sup>th</sup> percentile of the long-term means. Example numeric nutrient criteria were developed for the analyzed loading scenarios using this proposed approach and are presented in Table 16. The criteria were calculated by computing annual geometric means for each of the three years (2009–2011). Candidate numeric nutrient criteria for TN, TP, and chlorophyll *a* were then calculated as the 90<sup>th</sup> percentile of these geometric means.

**Table 16. Example of numeric nutrient criteria**

	Nutrient load alternative scenarios		
	S1	S2	S3
TN (mg/L)	1.44	0.98	1.20
TP (mg/L)	0.070	0.053	0.062
Chlorophyll <i>a</i> ( $\mu$ g/L)	34.7	30.9	33.0

## 7 Summary and Conclusions

- 1 The LSPC-EFDC-WASP complex of models is a well-suited tool for simulating the cause-and-effect relationship between the pollutants of concern (TN and TP) and chlorophyll a, water clarity and DO as the selected response parameters or endpoints. The specified values of the response parameters can serve as the targets for numerical nutrient criteria.
- 2 The models consider basic hydrologic, chemical, and biological processes and input of meteorological factors in Weeks Bay and input of point and nonpoint sources of pollution from the contributing watersheds.
- 3 The time variable, three-dimensional system of hydrodynamic and water quality models of Weeks Bay was calibrated and validated with data collected by ADEM, NERRS, EPA and NOAA during a period spanning from 2008 to 2011.
- 4 The calibrated EFDC-based hydrodynamic model represents the overall circulation and mixing characteristics of the Weeks Bay system on the basis of reasonably good agreement between observed and calculated temporal and spatial distributions of water surface elevations, salinity, and temperature.
- 5 The calibrated WASP-based water quality model reasonably represents the overall phytoplankton, nutrient and DO interactions in the Weeks Bay system. The water quality simulations show reasonably good agreement with continuous and monthly observed data.
- 6 Nutrient loading scenarios were selected to evaluate the effects of nutrient load reductions on the aforementioned endpoints in Weeks Bay. The scenarios are S1—existing loads, S2—no anthropogenic loads, and S3—50 percent reduction of anthropogenic loads. The scenarios S1 and S2 presumably represent current and lowest possible levels: S3 presents an example of an intermediate level of loading.
- 7 Presumably, endpoints will be defined for Weeks Bay by regulatory agencies. Modeling can be used to determine the nutrient reductions necessary to meet the desired endpoint values.
- 8 Analysis of outputs of loading scenarios allows estimation of sensitivity of the Weeks Bay endpoints to anthropogenic nutrient loads. For the scenario with no anthropogenic part of the nutrient load, the primary production rate changes by 27 percent. The correspondent change for the 90th percentile of chlorophyll a is 13 percent. The light extinction coefficient shows low sensitivity to phytoplankton concentrations. The major part of the light attenuation is caused by colored waters and TSS. DO does not meet the Alabama DO criteria 8.1 percent, 10.4 percent and 9.1 percent for the 2009–2011 period for scenarios S1, S2 and S3, respectively. Decreasing of phytoplankton biomass with the reduction of nutrients loadings lead to decreasing of oxygen production with photosynthesis and small decrease of oxygen concentrations in the middle layer of the bay.
- 9 Examples of pilot numeric nutrient criteria were calculated as 90th percentile of annual geometric means for TN, TP, and chlorophyll a. Values for each scenario correspond to values of the endpoints, calculated on basis of the corresponding model outputs.
- 10 Updating the simulation scenarios to include relationships that connect reduction of the nutrient loads with the reduction of the river boundary values of phytoplankton and SOD would significantly increase the model sensitivity and response to the nutrient loading.
- 11 Express the effect of changes in light attenuation on the areal extent of depths with light sufficient to support SAV growth under the various scenarios.



- 12 Adding a 4th scenario looking at a 150% anthropogenic load scenario would increase the gradient for evaluating modeled nutrient loads versus response condition and would inform whether current conditions are at an assimilative maximum or whether increased loadings would continue to exacerbate empirically observed adverse responses to nutrient enrichment.

## 8 References

- Ambrose, R.B., T.A. Wool, J.P. Connolly, and R.W. Schanz. 1988. *WASP4, A Hydrodynamic and Water Quality Model – Model Theory, User’s Manual and Programmer’s Guide*. EPA/600/3-87-039. U.S. Environmental Protection Agency, Athens, GA.
- ASTM (American Society for Testing and Materials). 1984. *Standard Practice for Evaluating Environmental Fate Models of Chemicals*. Designation E978-84. American Society for Testing and Materials, Philadelphia, PA.
- Cole, T., and S. Wells. 2006. CE-QUAL-W2, edited. Hydrodynamic and Water Quality Model. Portland State University, Portland, OR.
- Donigian, A.S., Jr. 2000. *HSPF Training Workshop Handbook and CD. Lecture #19. Calibration and Verification Issues*. Prepared for and presented to the U.S. Environmental Protection Agency, Office of Water, Office of Science and Technology, Washington, DC.
- GOMA (Gulf of Mexico Alliance). 2013. *Pilot Nutrient Criteria for Estuaries of the Gulf of Mexico: Sources, Fate, Transport, and Effects (SFTE): Weeks Bay, Alabama. Appendix A – Empirical Analysis of Monitoring Results*. Prepared for the Gulf of Mexico Alliance, Nutrients Priority Issues Team (Alabama Department of Environmental Management, and the Mississippi Department of Environmental Quality), by Tetra Tech, Inc., Owings Mills, Maryland. Xxx pages. For further information, contact Mr. Lynn Sisk by phone (334) 271-7826, or email [LS@adem.state.al.us](mailto:LS@adem.state.al.us).
- Hamrick, J.M. 1992. *A Three-Dimensional Environmental Fluid Dynamics Computer Code: Theoretical and Computational Aspects*. Special Report 317. The College of William and Mary, Virginia Institute of Marine Science, Gloucester Point, VA.
- McCutcheon, S.C. 1989. *Water Quality Modeling: Vol. I: Transport and Surface Exchange in Rivers*, CRC Press, Boca Raton, Florida.
- McCutcheon, S.C., Z. Donwei, and S. Bird. 1990. Model Calibration, Validation and Use. Pages 5.1–5.77 in *Manual for Performing Waste Load Allocations, Book III, Part 2*. EPA 823-R-92-003. U.S. Environmental Protection Agency, Office of Water, Washington, DC.
- Miller-Way, T., M. Dardeau, and G. Grozier. 1996. *Weeks Bay National Estuarine Research Reserve: An Estuarine Profile and Bibliography*. Dauphin Island Sea Lab Technical Report 96-01. [http://neris.noaa.gov/Doc/PDF/Reserve/WKB\\_SiteProfile.pdf](http://neris.noaa.gov/Doc/PDF/Reserve/WKB_SiteProfile.pdf).
- Fry, J., G. Xian, S. Jin, J. Dewitz, C. Homer, L. Yang, C. Barnes, N. Herold, and J. Wickham. 2011. Completion of the 2006 National Land Cover Database for the Conterminous United States. *Photogrammetric Engineering & Remote Sensing* 77(9):858–864.
- Smith, S.V., and J.T. Hollibaugh. 1993. Coastal metabolism and the oceanic carbon balance. *Reviews of Geophysics* 31(1):75–90.
- Tetra Tech. 2002. *User’s Manual for Environmental Fluid Dynamics Code: Hydrodynamics*. Prepared for U.S. Environmental Protection Agency Region 4, Atlanta, GA, by Tetra Tech, Inc., Fairfax, VA.
- Tetra Tech. 2007. *The Environmental Fluid Dynamics Computer Code Theory and Computation: Volume 1 Hydrodynamic and Mass Transport*. Tetra Tech, Inc., Fairfax, VA.

- Tetra Tech. 2012. *Mobile Bay Modeling Report*. Prepared for Mobile Bay National Estuary Program and Alabama Department of Environmental Management, Water Quality Branch, Montgomery, AL, by Tetra Tech, Inc., Atlanta, GA. For further information, contact Ms. Roberta Swann by phone (251) 431-6409, or email [rswann@mobilebaynep.com](mailto:rswann@mobilebaynep.com).
- Thomann, R.V., D.M. Di Toro, R.P. Winfield and D.J. O'Connor. 1975. *Mathematical Modeling of Phytoplankton in Lake Ontario, 1. Model Development and Verification*. EPA-600/3-75-005. U.S. Environmental Protection Agency, Corvallis, OR.
- Thomann, R.V., and J.J. Fitzpatrick. 1982. *Calibration and verification of a model of the Potomac Estuary*. Prepared for D.C. Department of Environmental Services, Washington, DC, by Hydroqual, Inc., Mahwah, N.J.
- USEPA (U.S. Environmental Protection Agency). 2011. *Weeks Bay Water Quality Study Final Report*. U.S. Environmental Protection Agency, Science and Ecosystem Support Division, Athens, GA.
- Wool, T.A., S.R. Davie, and H.N. Rodriguez. 2003. Development of three-dimensional hydrodynamic and water quality models to support TMDL decision process for the Neuse River Estuary, North Carolina. *Journal of Water Resources Planning and Management* 129:295–306.



## *Appendix A*

# **Modeling of Hydrological Regime of Weeks Bay: Calibration and Validation**

## Contents

A-1 Salinity Dynamics.....	A-4
A-2 Water Temperature Dynamics.....	A-11
A-3 Depth Dynamics.....	A-16

## Figures

Figure A-1.1 Salinity dynamics at NERRS Middle Bay (MB) station.....	A-5
Figure A-1.2 Salinity dynamics at NERRS Weeks Bay (WB) station.....	A-6
Figure A-1.3 Salinity dynamics at NERRS Magnolia River (MR)station.....	A-6
Figure A-1.4 Salinity dynamics at NERRS Fish River (FR) station.....	A-7
Figure A-1.5 Salinity dynamics at ADEM WKBB1 station.....	A-7
Figure A-1.6 Salinity dynamics at ADEM WKBB2 station.....	A-8
Figure A-1.7 Salinity dynamics at ADEM WKBB4 station.....	A-8
Figure A-1.8 Salinity dynamics at ADEM WKBB5 station.....	A-9
Figure A-1.9 Salinity dynamics at ADEM WKBB6 station.....	A-9
Figure A-1.10 Salinity dynamics at ADEM WB1 station.....	A-10
Figure A-2.1 Water Temperature dynamics at NERRS Middle Bay (MB) station.....	A-12
Figure A-2.2 Water Temperature dynamics at NERRS Weeks Bay (WB) station.....	A-12
Figure A-2.3 Water Temperature dynamics at NERRS Magnolia River (MR) station.....	A-13
Figure A-2.4 Water Temperature dynamics at NERRS Fish River (FR) station.....	A-13
Figure A-2.5 Water Temperature dynamics at ADEM WKBB1 station.....	A-14
Figure A-2.6 Water Temperature dynamics at ADEM WKBB5 station.....	A-14
Figure A-2.7 Water Temperature dynamics at ADEM WKBB6 station.....	A-15
Figure A-3.1 Water Depth dynamics at NERRS Middle Bay (MB) station.....	A-17
Figure A-3.2 Water Depth dynamics at NERRS Weeks Bay (WB) station.....	A-17
Figure A-3.3 Water Depth dynamics at NERRS Magnolia River station.....	A-18
Figure A-3.4 Water Depth dynamics at NERRS Fish River (FR) station.....	A-18

## Tables

Table A-1.1	Comparisons of simulations and measurements of salinity at NERRS monitoring stations: years 2008-2011 .....	A-4
Table A-1.2	Comparisons of simulations and measurements of salinity at ADEM monitoring stations: year 2011 .....	A-4
Table A-1.3	Quality of salinity calibration and validation.....	A-5
Table A-2.1	Comparisons of simulations and measurements of Water Temperature at NERRS monitoring stations: years 2008-2011 .....	A-11
Table A-2.2	Comparisons of simulations and measurements of Water Temperature at ADEM monitoring stations: year 2011.....	A-11
Table A-2.3	Quality of salinity calibration and validation.....	A-11
Table A-3.1	Comparisons of simulations and measurements of depth dynamics at NERRS monitoring stations: years 2008-2011 .....	A-16

## A-1 Salinity Dynamics

Tables A-1.1 and A-1.2 as well as Figures A-1.1 through A-1.10 represent the numerical and visual comparisons of salinity simulations in surface in bottom layers of the Weeks Bay EFDC model with the available NERRS and ADEM monitoring data that were collected during years 2008-2011.

The numerical metrics of correspondence of salinity simulations vs. measurements are presented in Tables A-1.1 and A-1.2.

**Table A-1.1 Comparisons of simulations and measurements of salinity at NERRS monitoring stations: years 2008-2011**

Station	Simulations (ppt)		Measurements (ppt)	Deviation (%)	
	Mean Surface	Mean Bottom	Mean	Surface	Bottom
Mid-Bay	3.4	8.8	10	-66	-12
Weeks Bay	5.9	10	11.1	-47	-10
Magnolia River	1	6.2	9.7	-90	-36
Fish River	3	5.9	6.4	-53	-8

**Table A-1.2 Comparisons of simulations and measurements of salinity at ADEM monitoring stations: year 2011**

Station	Simulations (ppt)		Measurements (ppt)	Deviation (%)	
	Mean Surface	Mean Bottom	Mean	Surface	Bottom
WB1	3.8	7.1	6.9	-45	3
WKBB1	4.7	9	8.6	-45	5
WKBB2	7.5	14.9	11	-32	35
WKBB4	3.6	10	8.8	-59	14
WKBB5	4.6	7	6.7	-31	4
WKBB6	6.9	13	9.9	-30	31

The deviations of bottom and surface salinity are in a range of 3-36% and 31-90% correspondently. The tables demonstrate the high salinity stratification of Weeks Bay.

The comparisons of the deviation values with the calibration quality rating table (Main Report) allow estimating the calibrated EFDC model performance at locations of the bay's monitoring station with grades that are presented in Table A-1.3

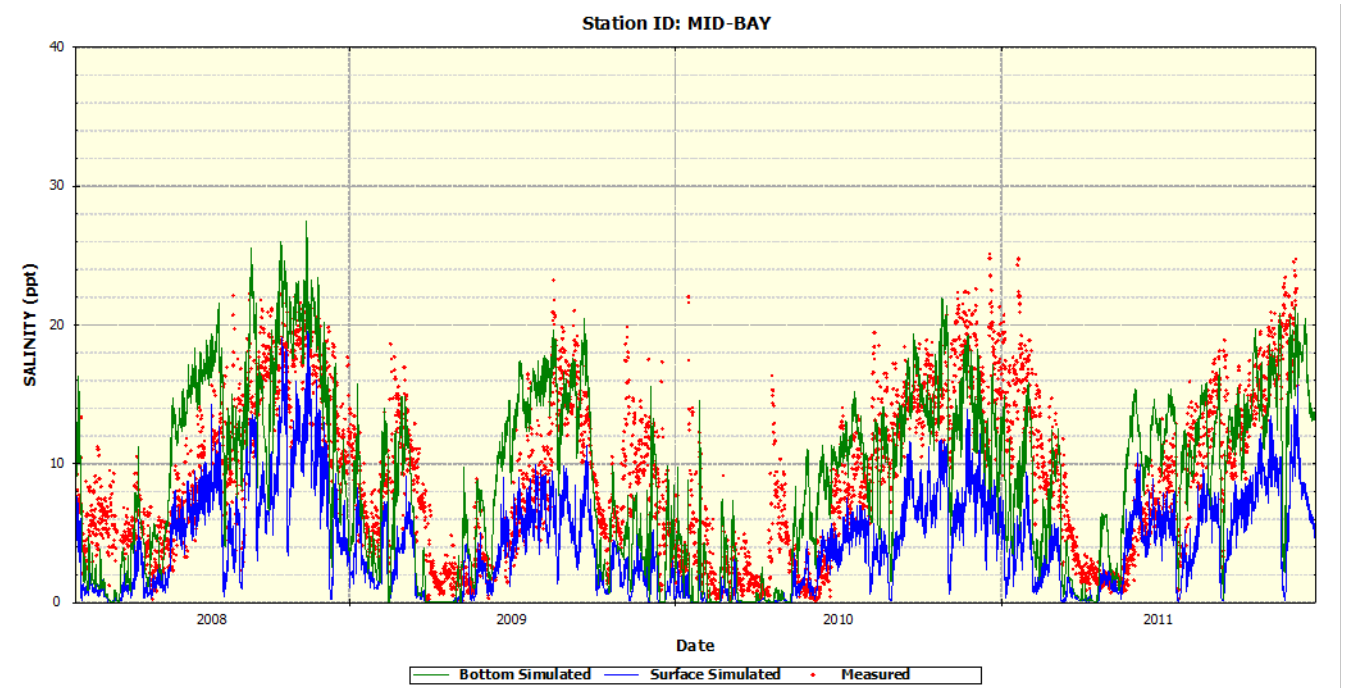

**Table A-1.3 Quality of salinity calibration and validation**

Station	Salinity
MB	Very Good
WB1	Very Good
MR	Fair
FR	Very Good
WB1	Very Good
WKBB1	Very Good
WKBB2	Fair
WKBB4	Very Good
WKBB5	Very Good
WKBB6	Fair

Simulated bottom layer concentrations of salinity are closer to measured data than simulated surface concentrations (Tables A-1.1 and A-1.2). The estimates of salinity calibration and validation (Table A-1.3) show that results for 7 stations received a grade of Very Good and 3 stations received a grade of Fair.

The figures A-1.1 through A-1.10 accurately display the ranges and general trends of salinity dynamics in different parts of the bay. Visual analysis of salinity dynamics at “Fair” stations WKBB2 and WKBB6 shows that the measured data fall in the range of bottom and surface simulations and can have a good correspondence with the middle layer simulations.



**Figure A-1.1 Salinity dynamics at NERRS Middle Bay (MB) station**

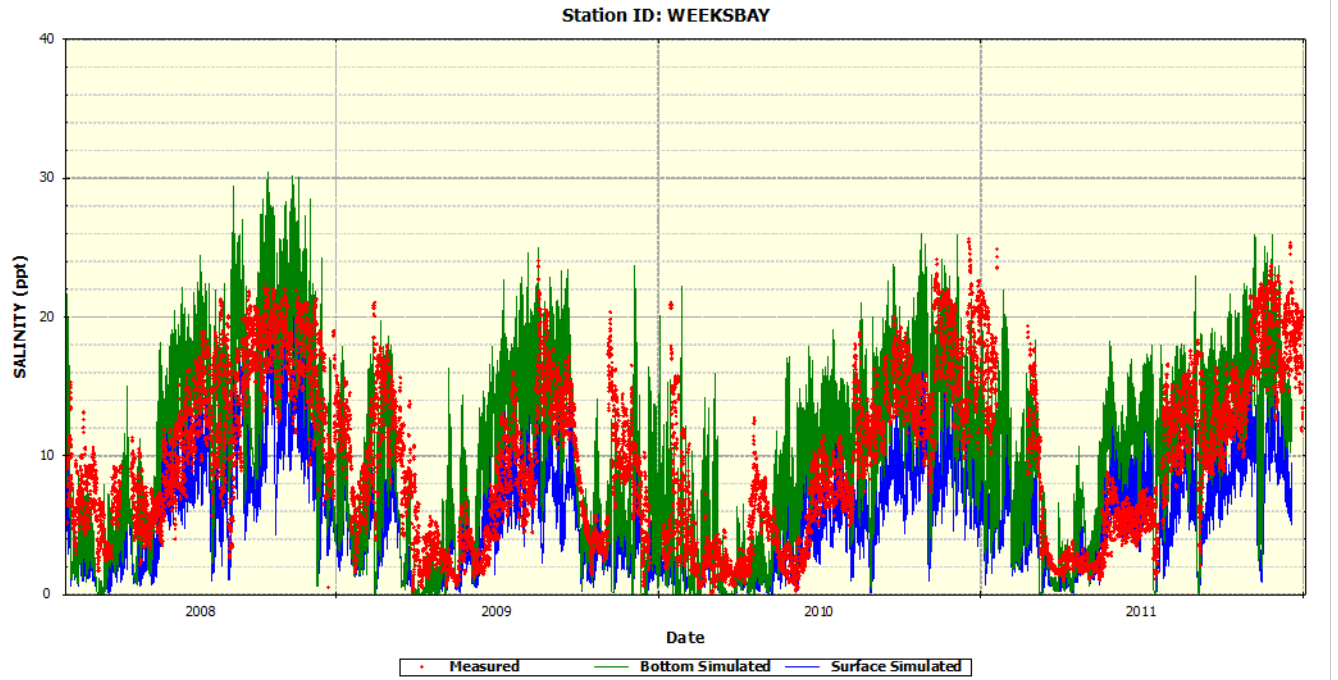

Figure A-1.2 Salinity dynamics at NERRS Weeks Bay (WB) station

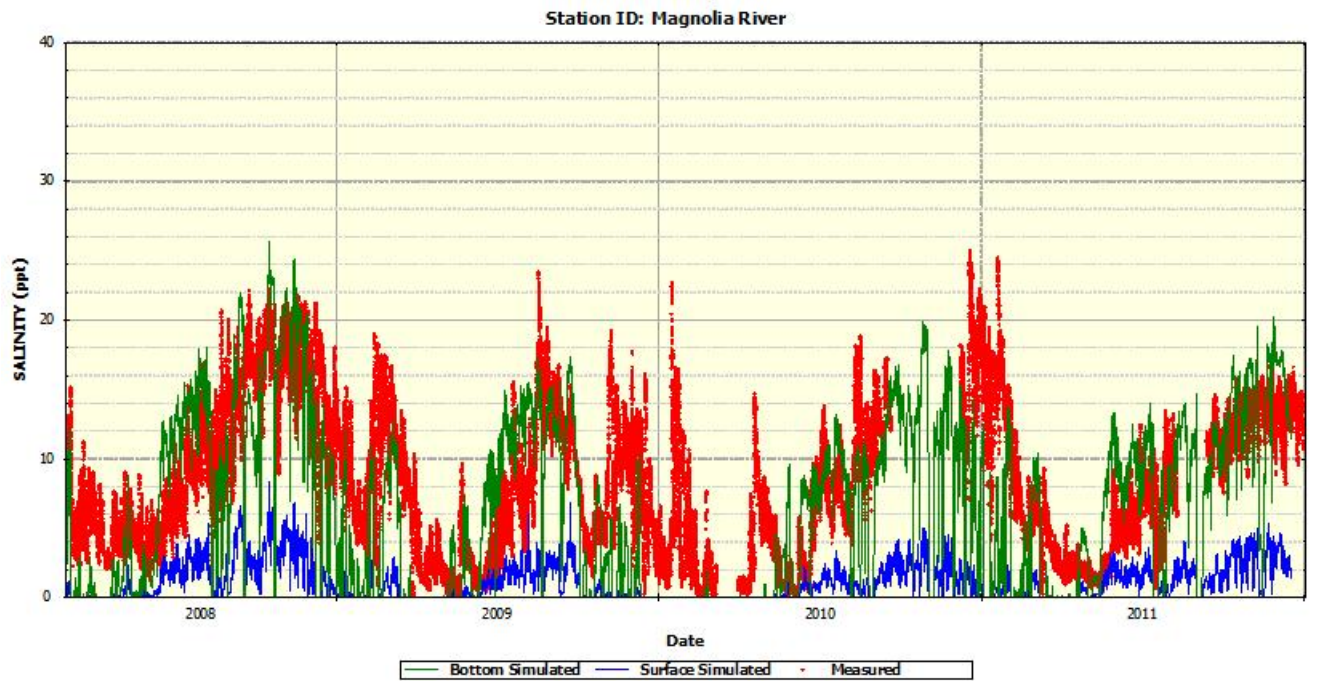

Figure A-1.3 Salinity dynamics at NERRS Magnolia River (MR) station

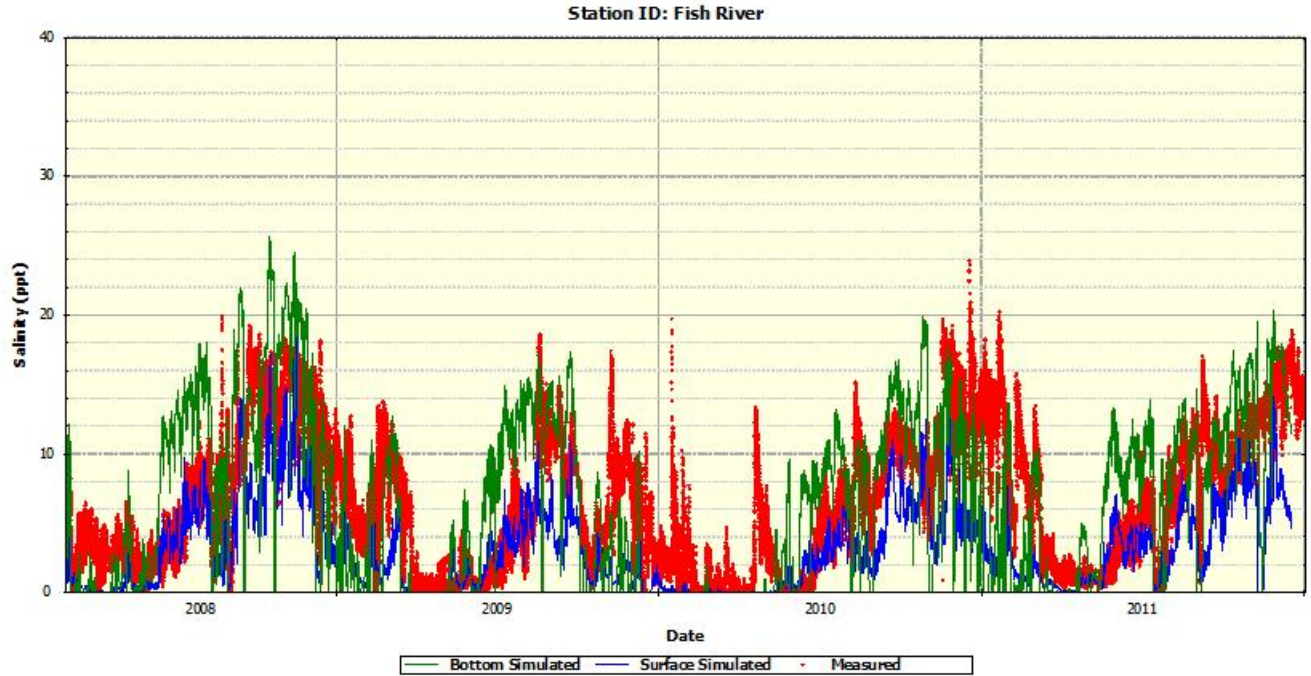

Figure A-1.4 Salinity dynamics at NERRS Fish River (FR) station

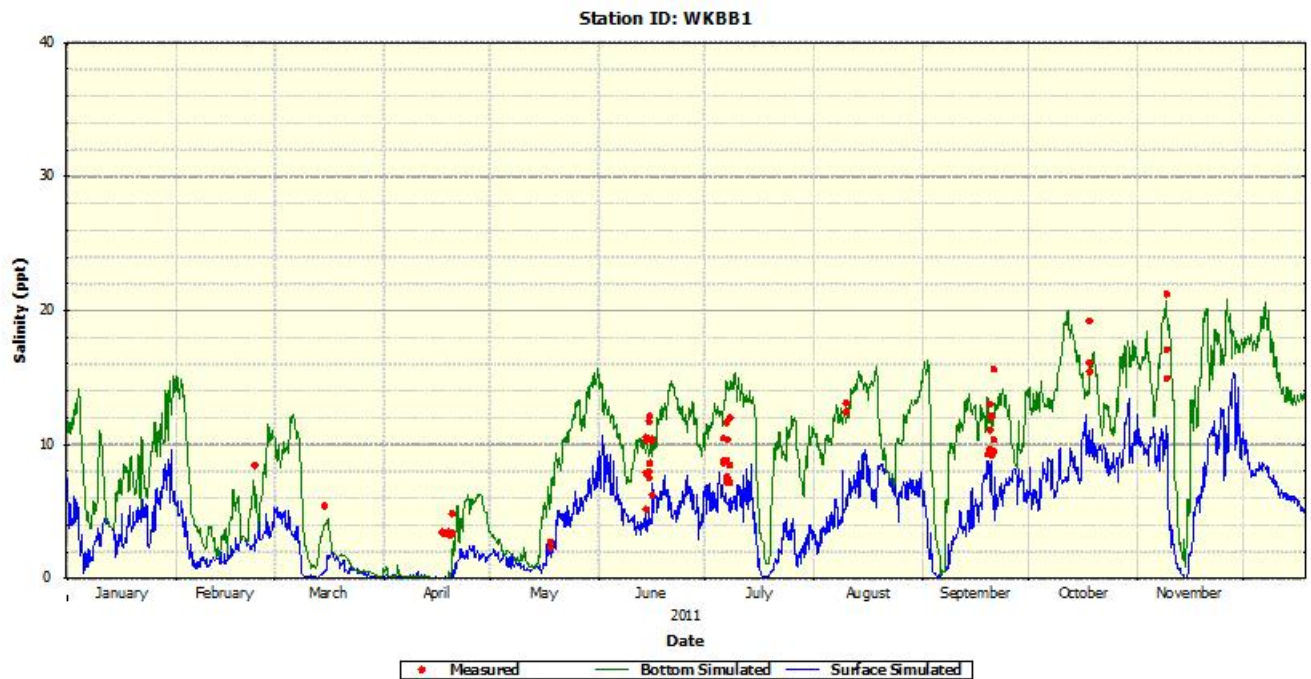

Figure A-1.5 Salinity dynamics at ADEM WKBB1 station

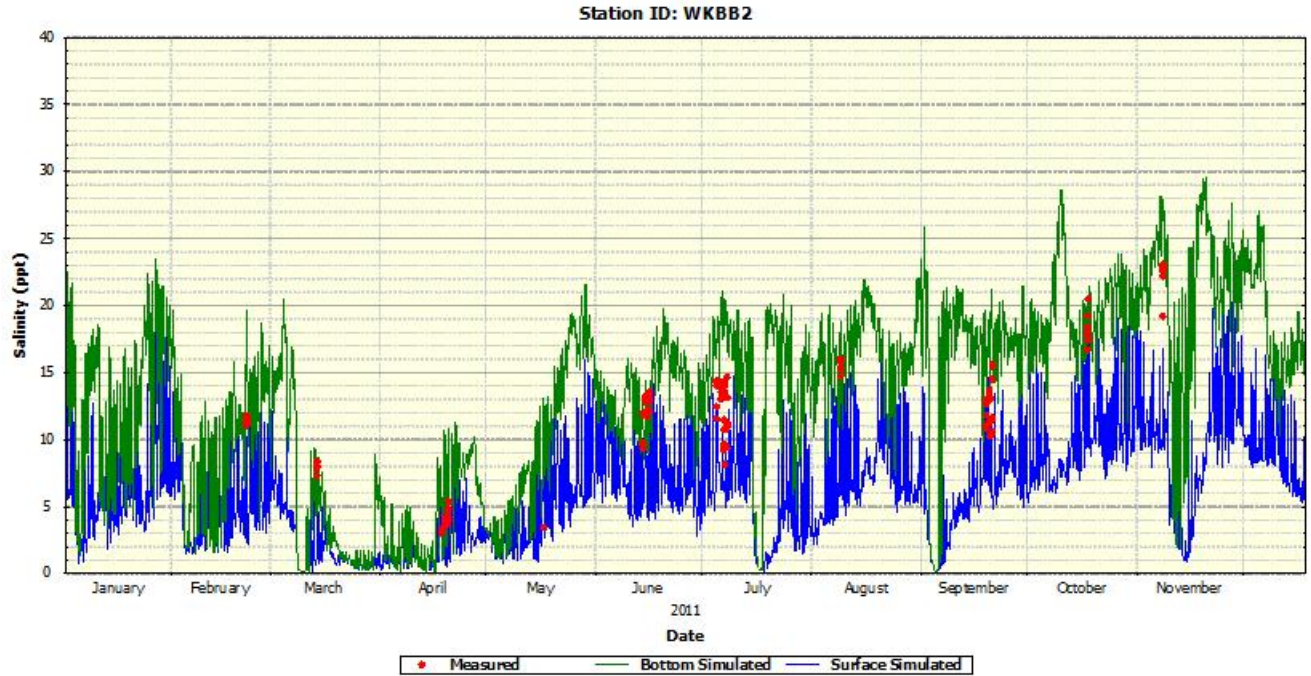

Figure A-1.6 Salinity dynamics at ADEM WKBB2 station

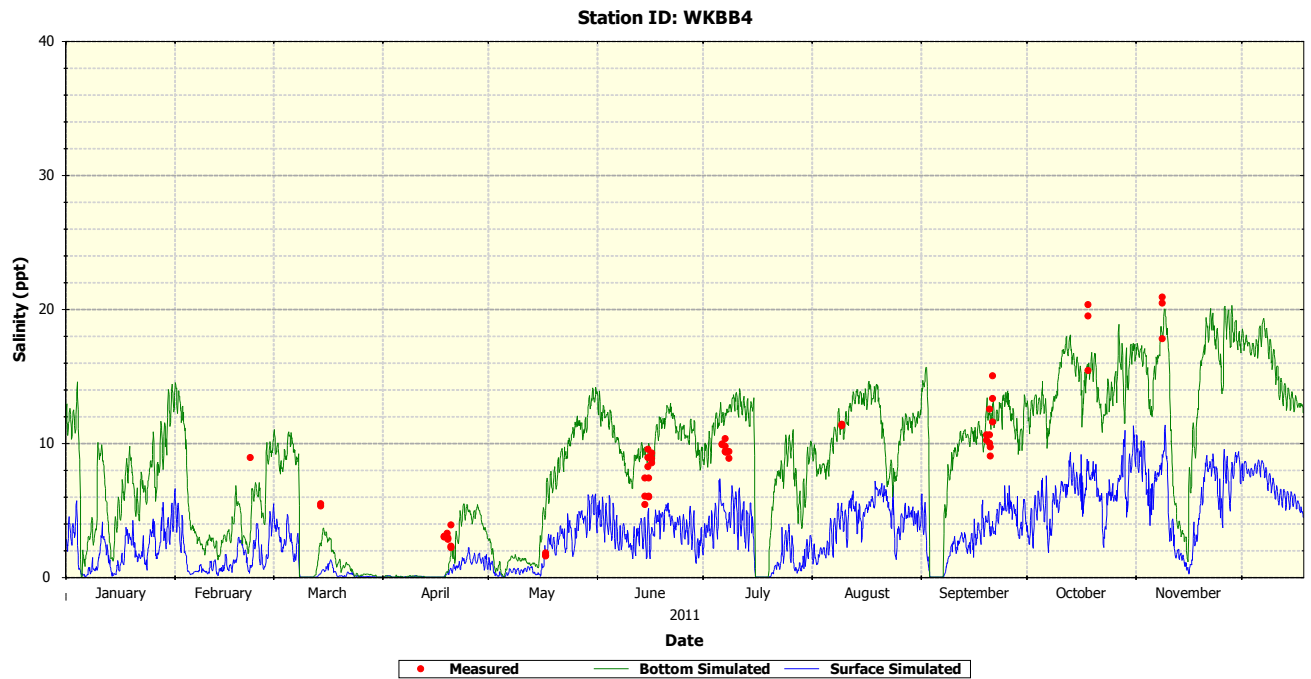
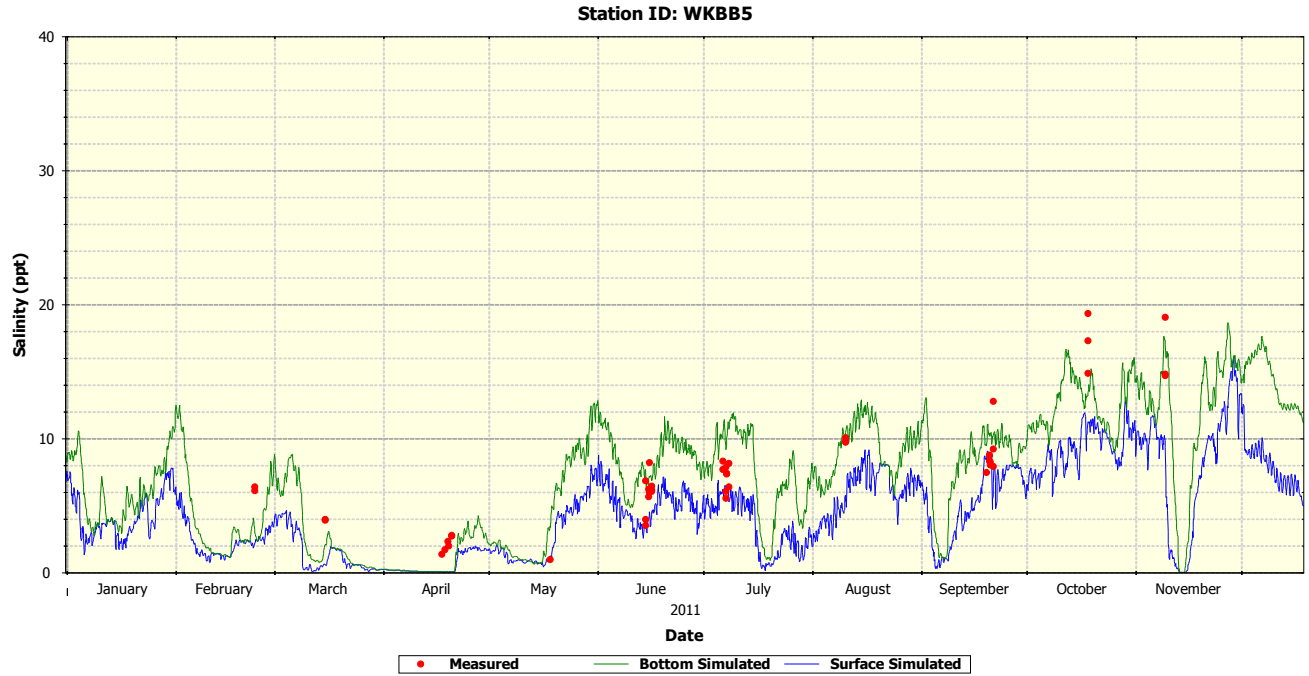
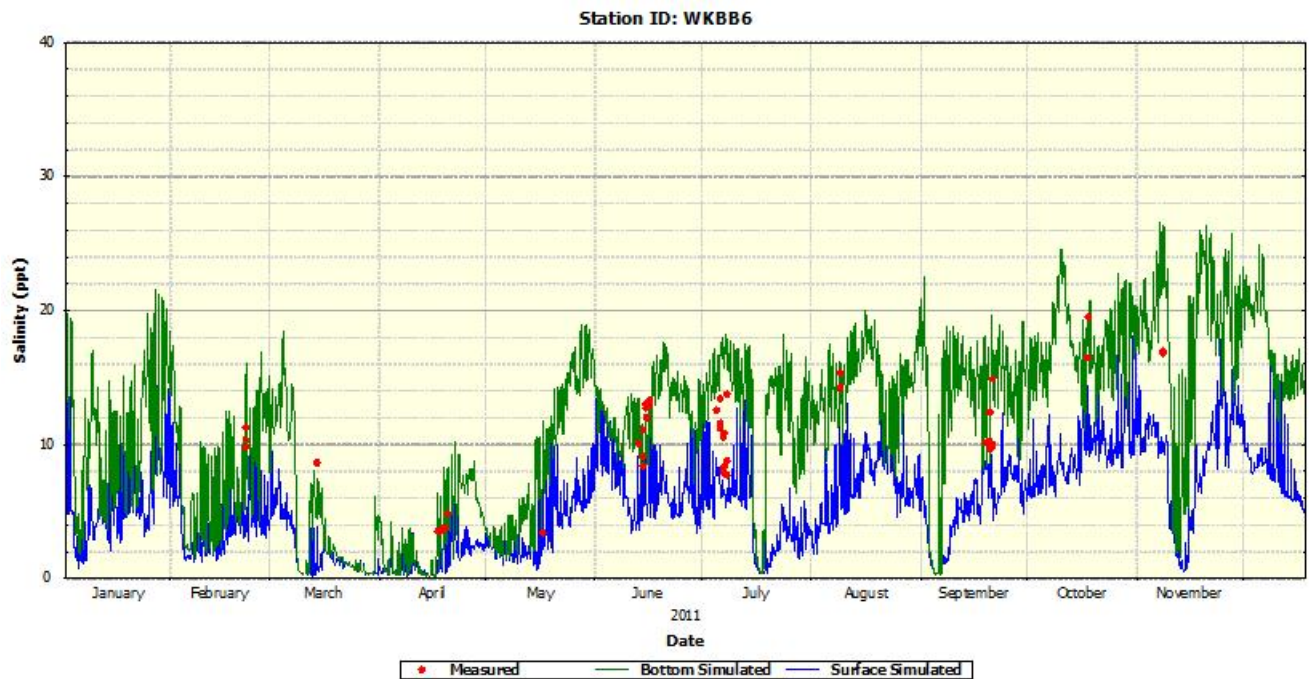

Figure A-1.7 Salinity dynamics at ADEM WKBB4 station



**Figure A-1.8 Salinity dynamics at ADEM WKBB5 station**



**Figure A-1.9 Salinity dynamics at ADEM WKBB6 station**

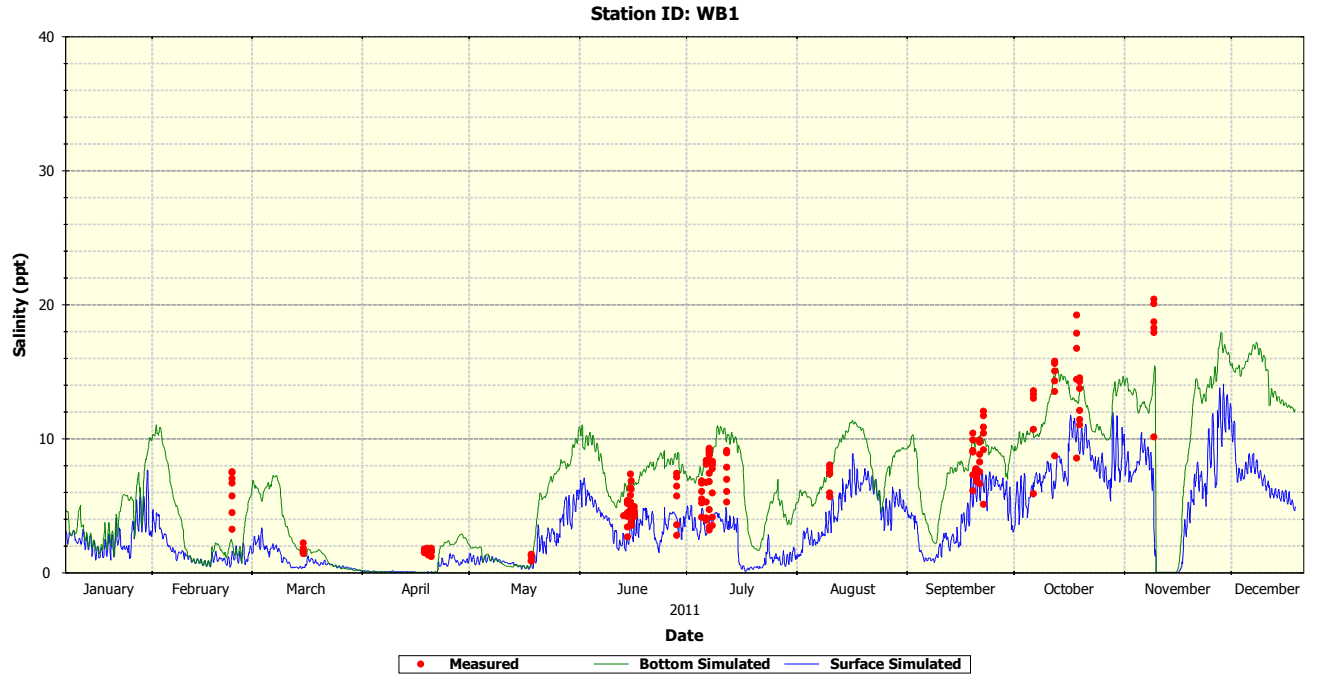

**Figure A-1.10** Salinity dynamics at ADEM WB1 station

## A-2 Water Temperature Dynamics

Tables A-2.1 and A-2.2 as well as Figures A-2.1 through A-2.7 represent the numerical and visual comparisons of water temperature simulations in the surface layer of the Weeks Bay EFDC model with the available NERRS and ADEM monitoring data that were collected during years 2008-2011.

The numerical metrics of correspondence of water temperature simulations vs. measurements are presented in Tables A-2.1 and A-2.2.

**Table A-2.1 Comparisons of simulations and measurements of Water Temperature at NERRS monitoring stations: years 2008-2011**

Station	Simulations (oC)	Measurements (oC)	Deviation (%)
	Mean Surface	Mean	
Mid-Bay	22.7	22.4	1
Weeks Bay	22.6	22.8	-1
Magnolia River	22.9	23	0
Fish River	22.6	22.1	2

**Table A-2.2 Comparisons of simulations and measurements of Water Temperature at ADEM monitoring stations: year 2011**

Station	Simulations (oC)	Measurements (oC)	Deviation (%)
	Mean Surface	Mean	
WB1	27.8	27.9	0
WKBB5	27.8	27.7	0
WKBB6	29	29.4	-1

The simulation-measurements deviations of water temperature are in a range of 0%-2%. The tables demonstrate the high accuracy of the temperature simulations in Weeks Bay.

The comparisons of the deviation values with the calibration quality rating table (Main Report) allow estimating the calibrated model performance for water temperature simulations at locations of the bay's monitoring station with grades that are presented in Table A-2.3

**Table A-2.3 Quality of salinity calibration and validation**

Station	Temperature
MB	Very Good
WB1	Very Good
MR	Very Good
FR	Very Good
WKBB1	Very Good
WKBB5	Very Good
WKBB6	Very Good

The figures A-2.1 through A-2.7 accurately display the ranges and trends of water temperature dynamics in different parts of the bay.

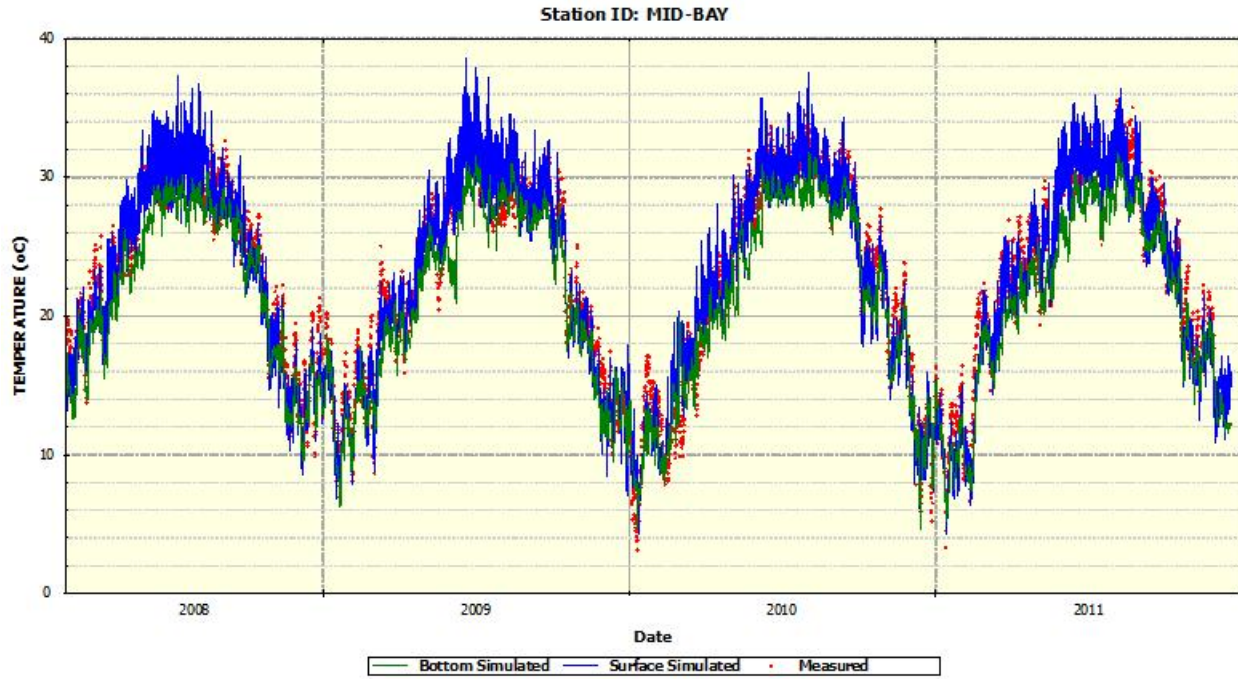

Figure A-2.1 Water Temperature dynamics at NERRS Middle Bay (MB) station

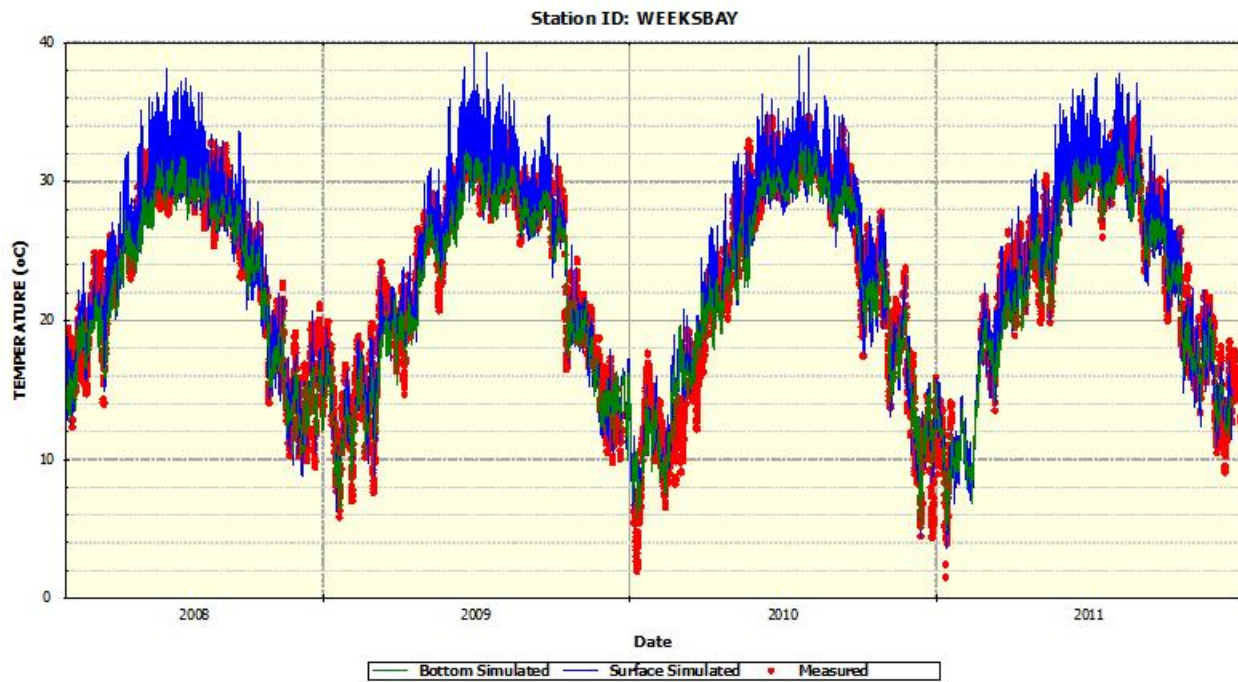

Figure A-2.2 Water Temperature dynamics at NERRS Weeks Bay (WB) station



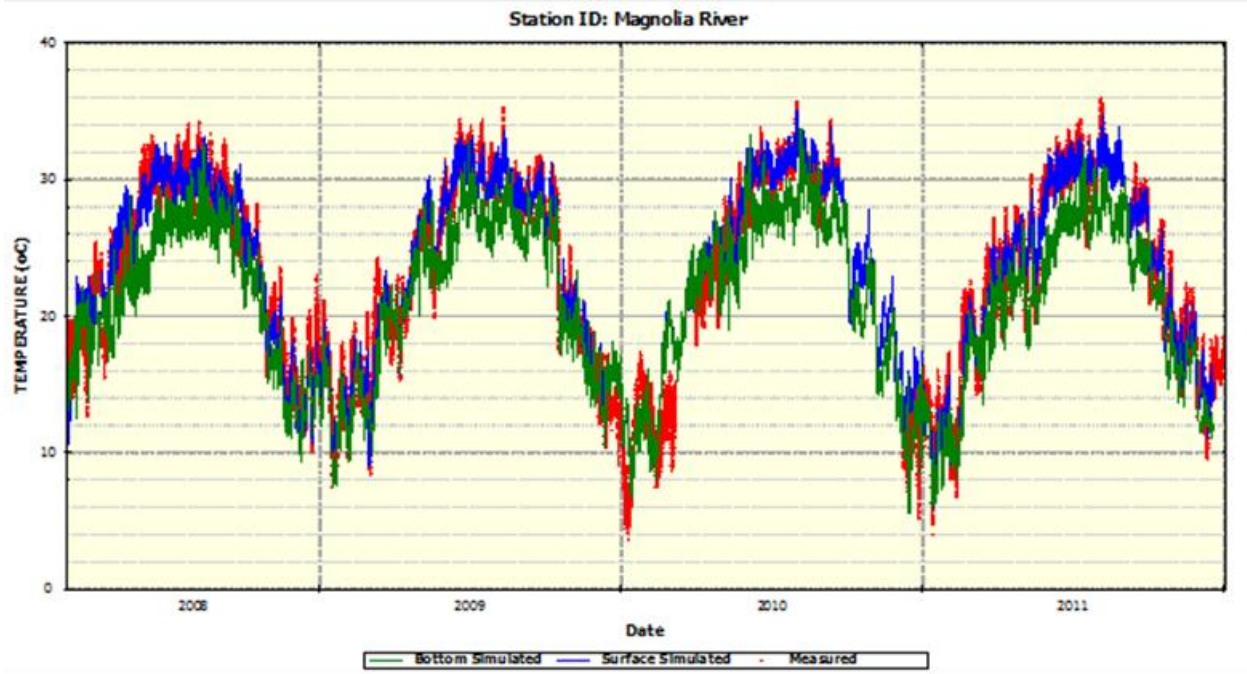

Figure A-2.3 Water Temperature dynamics at NERRS Magnolia River (MR) station

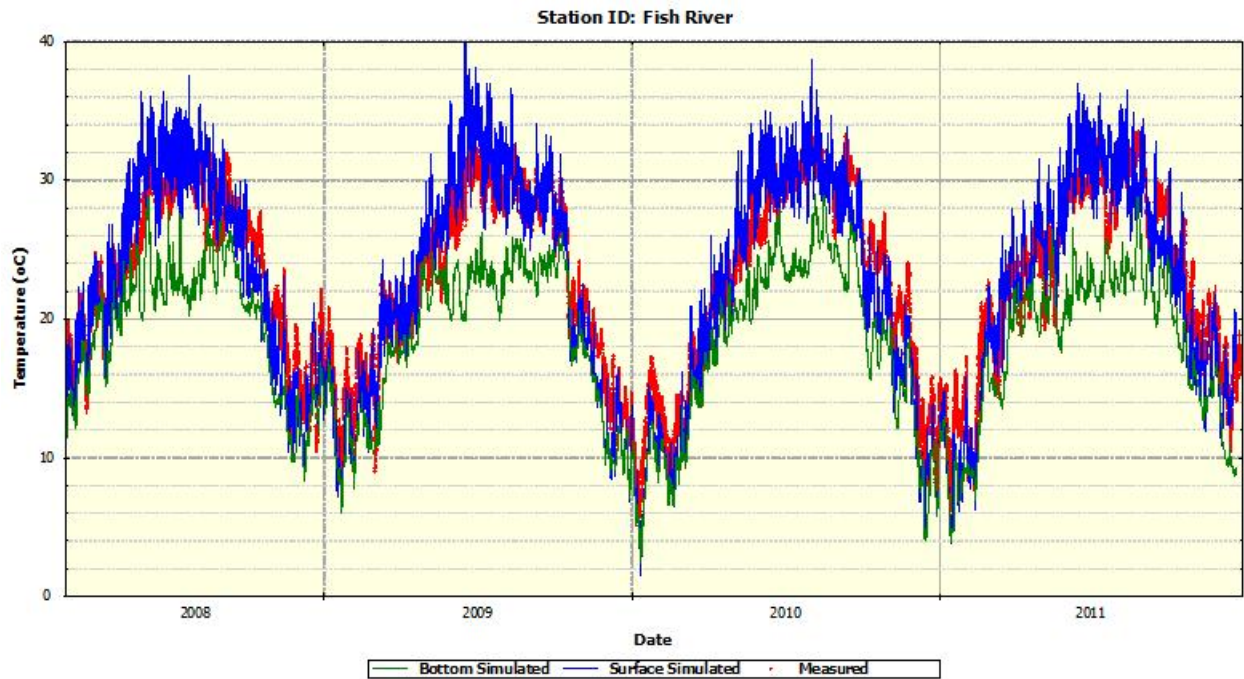

Figure A-2.4 Water Temperature dynamics at NERRS Fish River (FR) station

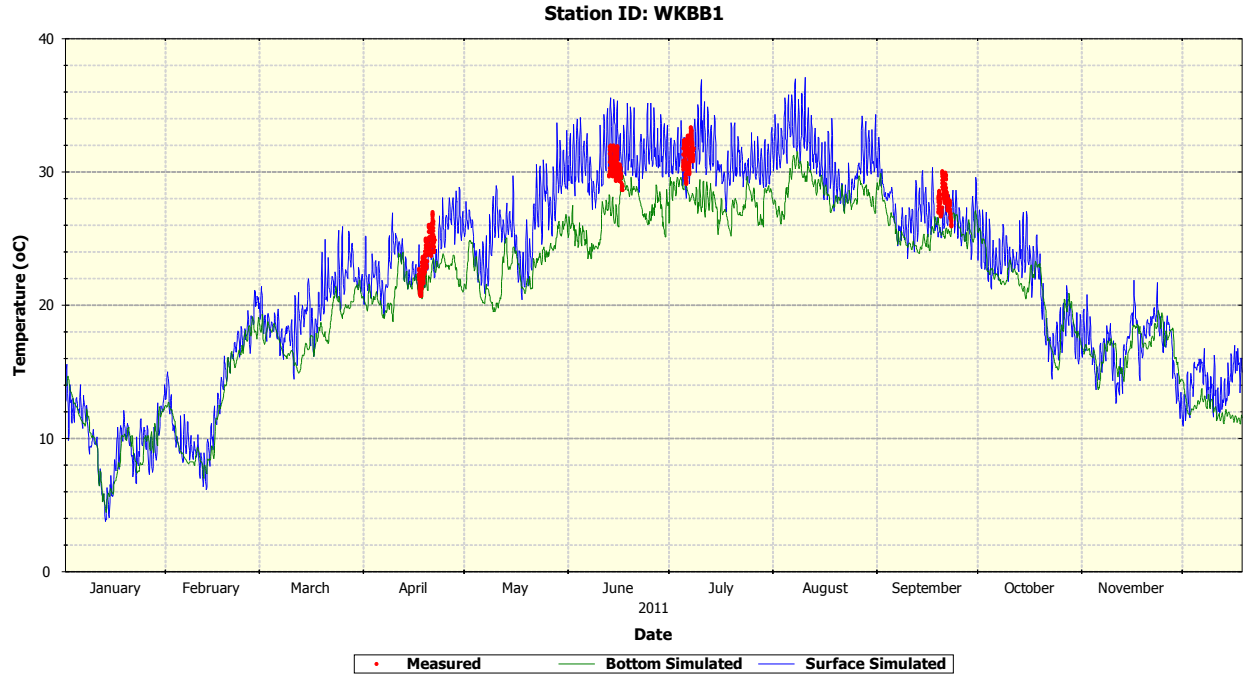

Figure A-2.5 Water Temperature dynamics at ADEM WKBB1 station

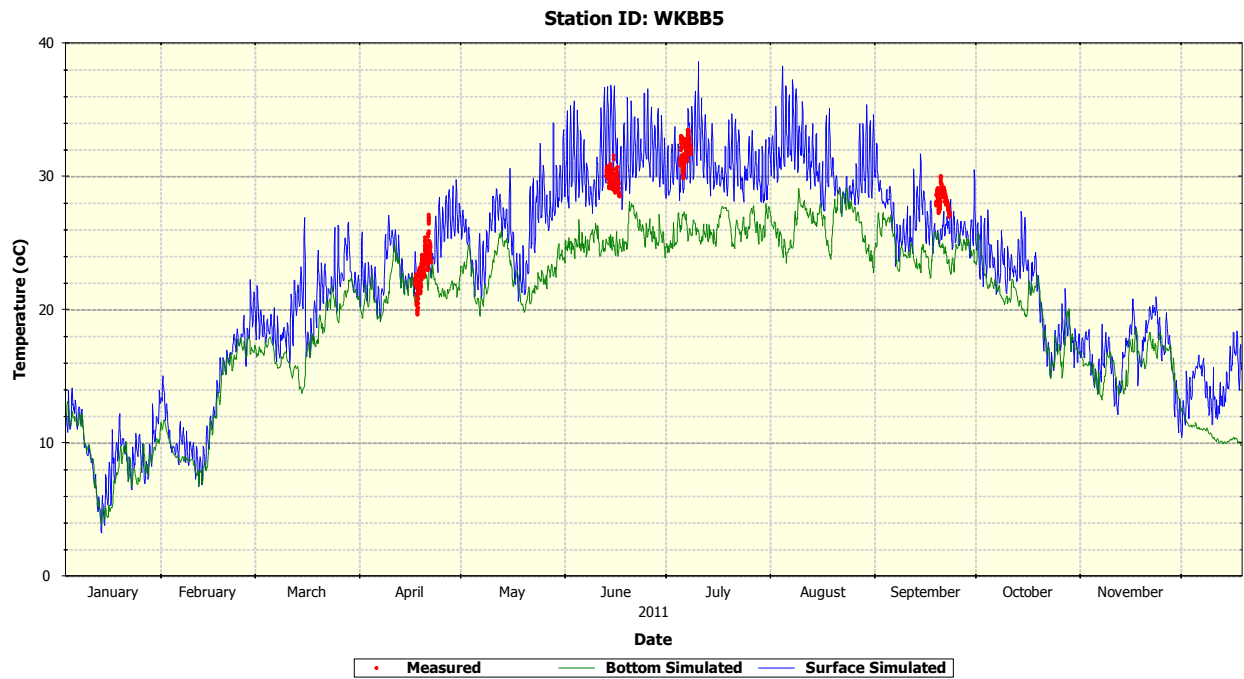
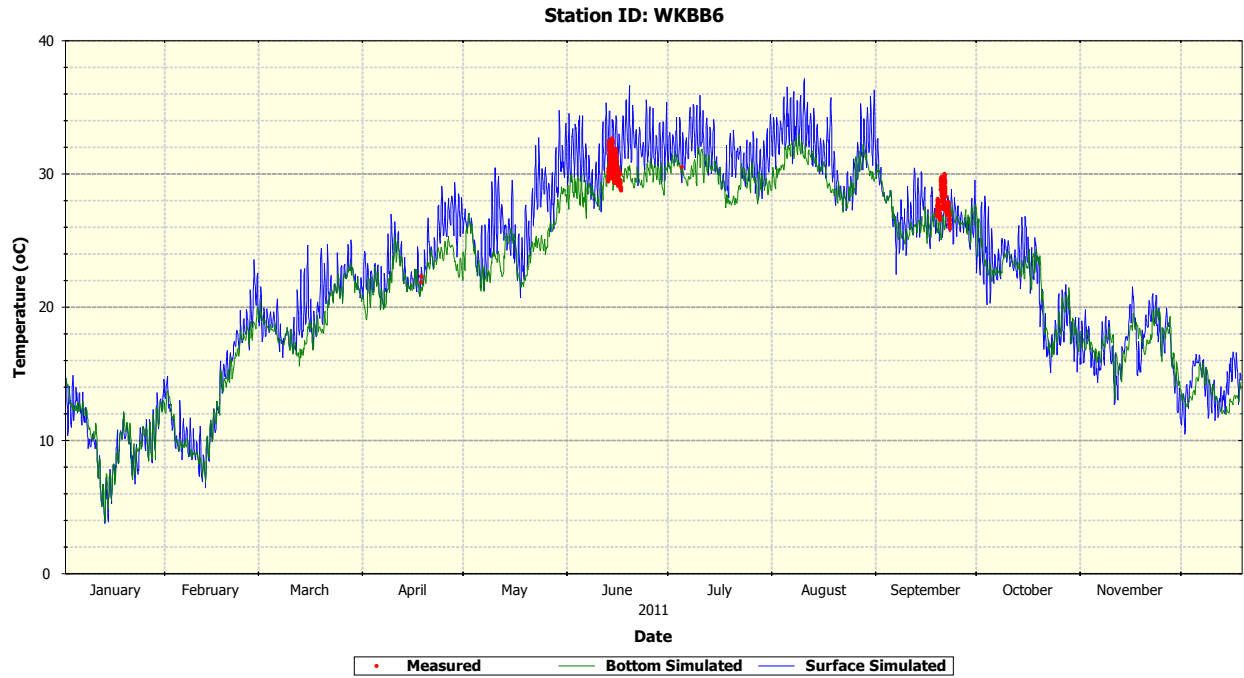

Figure A-2.6 Water Temperature dynamics at ADEM WKBB5 station



**Figure A-2.7**      **Water Temperature dynamics at ADEM WKBB6 station**

## A-3 Depth Dynamics

Measurements of depth dynamics at four NERRS monitoring stations at Weeks Bay during March – December 2008 were selected as calibration data sets; the depth dynamics measurements during 2009- 2011 were used as the validation data sets.

The calibration and validation processes use calculations of relative depth dynamics in locations of NERRS monitoring stations Mid-Bay, Weeks Bay, Magnolia River (MR) and Fish River.

Table A-3.1 and Figures A-3.1 through A-3.4 represent the numerical and visual comparisons of depth dynamics simulations with the available NERRS measurements that were collected during years 2008-2011.

The numerical metrics of correspondence of depth simulations vs. measurements are presented in Table A-3.1.

**Table A-3.1 Comparisons of simulations and measurements of depth dynamics at NERRS monitoring stations: years 2008-2011**

Station	Simulations (m)	Measurements (m)	Deviation (%)
	Mean	Mean	
Mid-Bay	1.18	1.1	7
Weeks Bay	1.13	1.25	-10
Magnolia River	1.77	1.66	7
Fish River	3.21	3.13	3

The table shows that the difference of means between observed and simulated oscillations of depth values are in the range of 7-12 cm with the deviation 3-10 percent in relation to measured depth.

Figures A-3.1 through A-3.4 demonstrates close correspondence of the calibrated model simulations to NERRS observations.

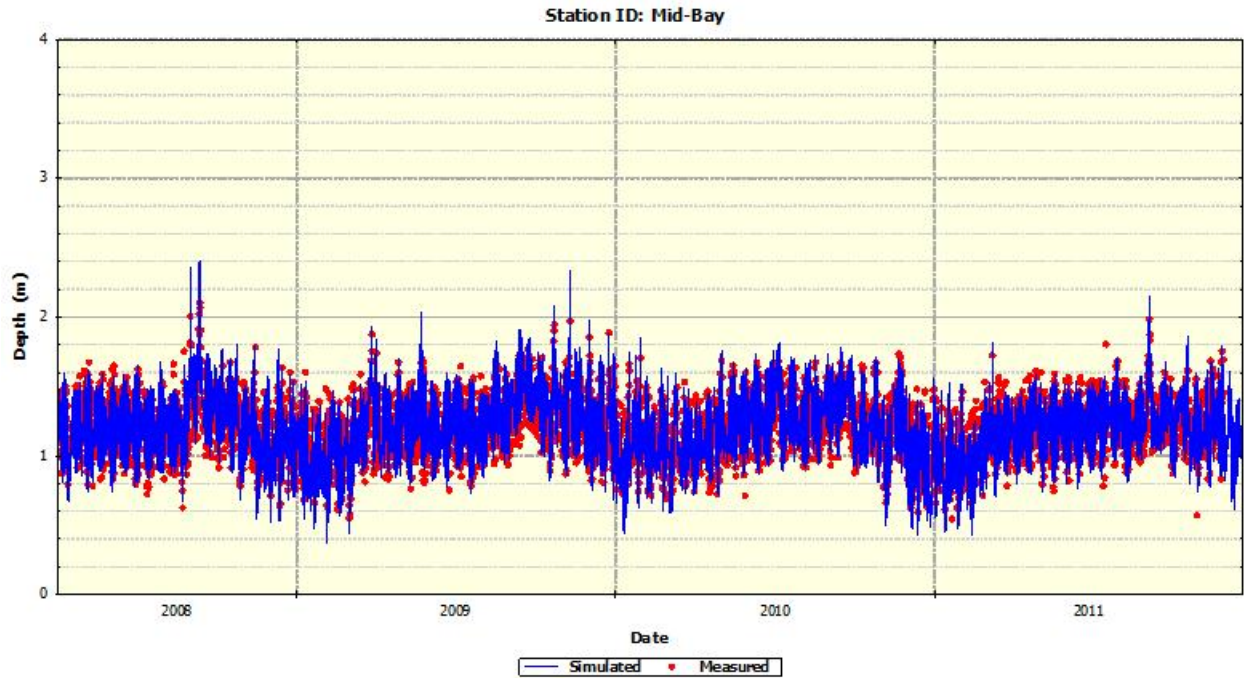

Figure A-3.1 Water Depth dynamics at NERRS Middle Bay (MB) station

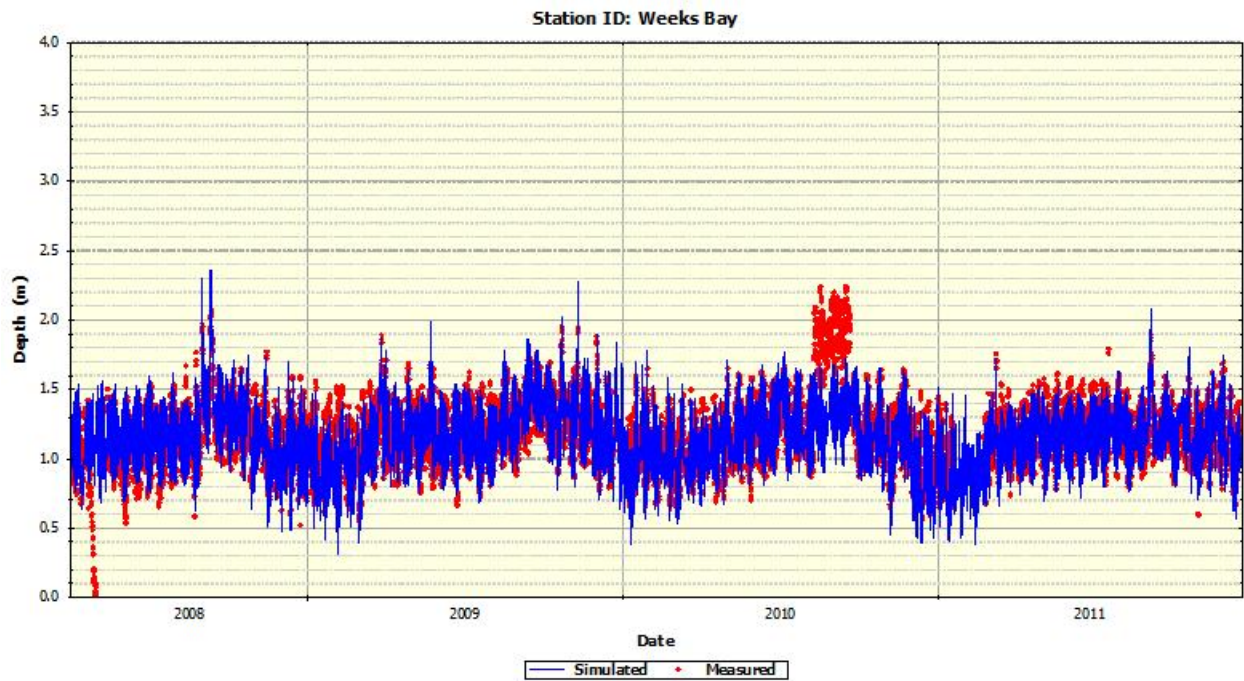

Figure A-3.2 Water Depth dynamics at NERRS Weeks Bay (WB) station

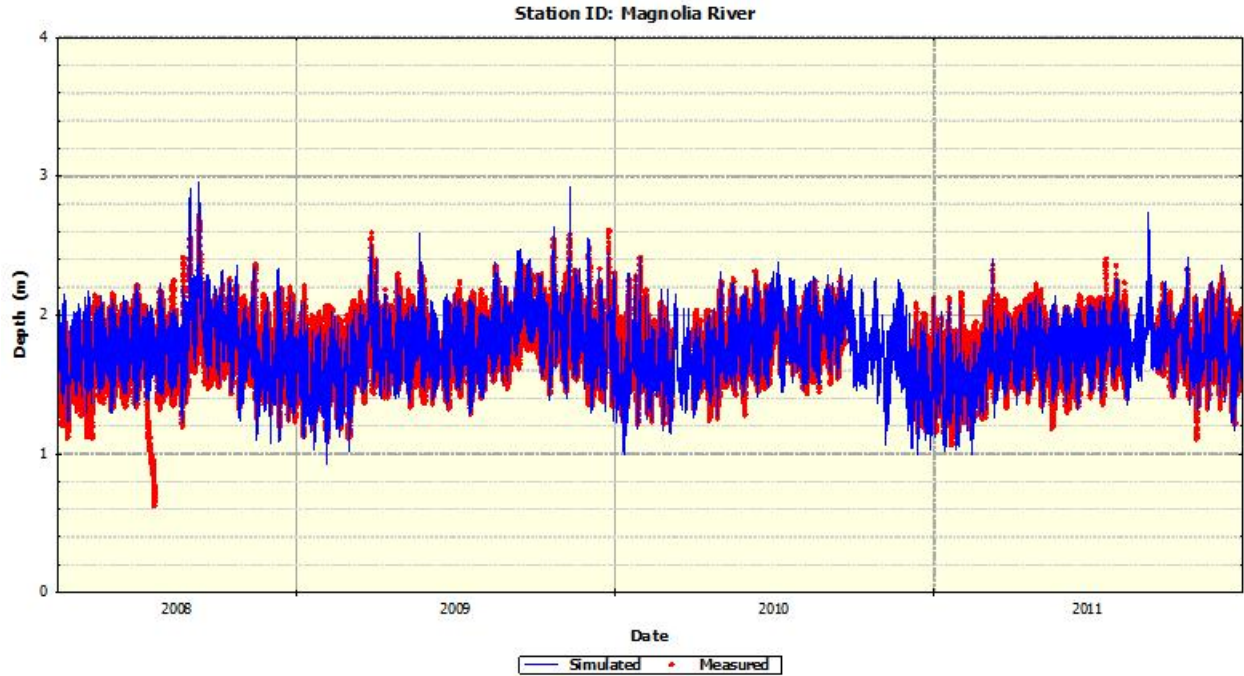

Figure A-3.3 Water Depth dynamics at NERRS Magnolia River station

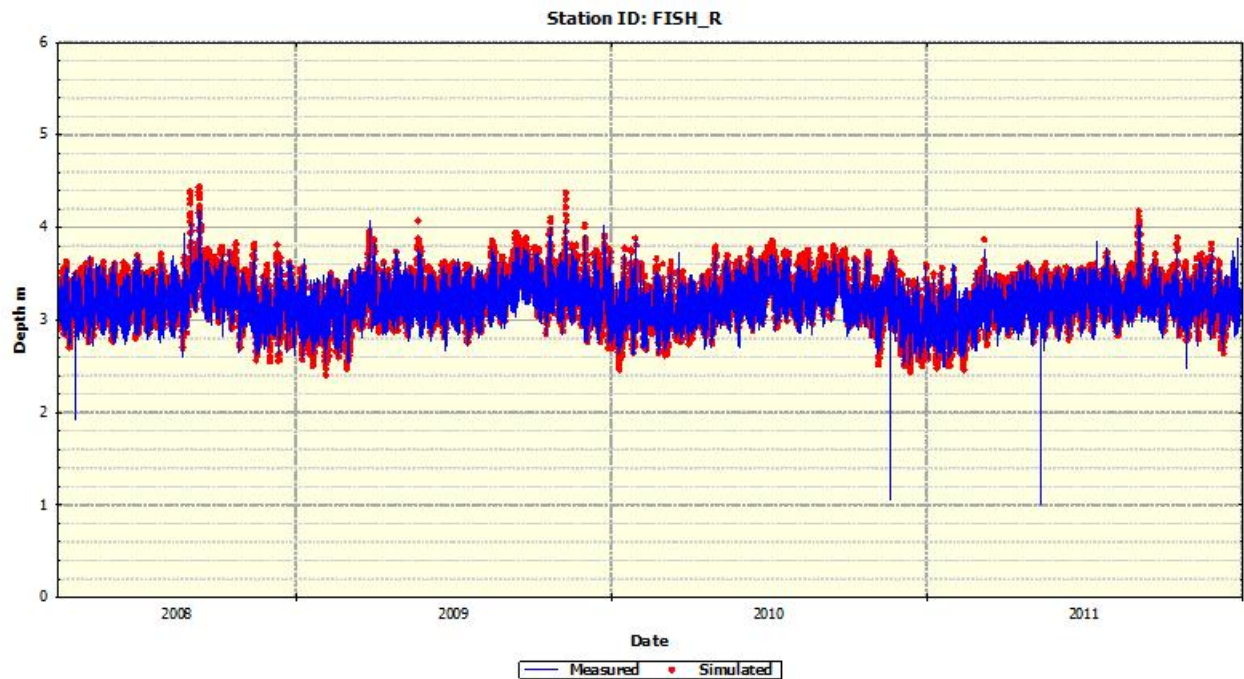

Figure A-3.4 Water Depth dynamics at NERRS Fish River (FR) station

## *Appendix B*

# **Modeling of Water Quality of Weeks Bay: Calibration and Validation**

## Contents

B-1 Dynamics of Chlorophyll <i>a</i> .....	B-5
B-2 Dynamics of Mineral Nitrogen.....	B-8
B-3 Dynamics of Mineral and Total Phosphorus.....	B-20
B-4 Dissolved Oxygen Dynamics.....	B-27
B-5 CBOD Dynamics.....	B-34
B-6 TSS Dynamics.....	B-38

## Figures

Figure B-1.1	Chlorophyll <i>a</i> dynamics at NERRS Middle Bay (MB) station.....	B-6
Figure B-1.2	Chlorophyll <i>a</i> dynamics at NERRS Weeks Bay (WB) station.....	B-6
Figure B-1.3	Chlorophyll <i>a</i> dynamics at NERRS Magnolia River (MR) station.....	B-7
Figure B-1.4	Chlorophyll <i>a</i> dynamics at NERRS Fish River (FR) station.....	B-7
Figure B-2.1.1	N-NH <sub>3</sub> dynamics at NERRS Middle Bay (MB) station.....	B-9
Figure B-2.1.2	N-NH <sub>3</sub> dynamics at NERRS Weeks Bay (WB) station.....	B-10
Figure B-2.1.3	N-NH <sub>3</sub> dynamics at NERRS Magnolia River (MR) station.....	B-10
Figure B-2.1.4	N-NH <sub>3</sub> dynamics at NERRS Fish River (FR) station.....	B-11
Figure B-2.1.5	N-NH <sub>3</sub> dynamics at ADEM WB1 station.....	B-11
Figure B-2.1.6	N-NH <sub>3</sub> dynamics at ADEM WKBB1 station.....	B-12
Figure B-2.1.7	N-NH <sub>3</sub> dynamics at ADEM WKBB2 station.....	B-12
Figure B-2.1.8	N-NH <sub>3</sub> dynamics at ADEM WKBB4 station.....	B-13
Figure B-2.1.9	N-NH <sub>3</sub> dynamics at ADEM WKBB5 station.....	B-13
Figure B-2.1.10	N-NH <sub>3</sub> dynamics at ADEM WKBB6 station.....	B-14
Figure B-2.2.1	N-NO <sub>3</sub> dynamics at NERRS Middle Bay (MB) station.....	B-15
Figure B-2.2.2	N-NO <sub>3</sub> dynamics at NERRS Weeks Bay (WB) station.....	B-15
Figure B-2.2.3	N-NO <sub>3</sub> dynamics at NERRS Magnolia River (MR) station.....	B-16
Figure B-2.2.4	N-NO <sub>3</sub> dynamics at NERRS Fish River (FR) station.....	B-16
Figure B-2.2.5	N-NO <sub>3</sub> dynamics at ADEM WB1 station.....	B-17
Figure B-2.2.6	N-NO <sub>3</sub> dynamics at ADEM WKBB1 station.....	B-17
Figure B-2.2.7	N-NO <sub>3</sub> dynamics at ADEM WKBB2 station.....	B-18
Figure B-2.2.8	N-NO <sub>3</sub> dynamics at ADEM WKBB4 station.....	B-18
Figure B-2.2.9	N-NO <sub>3</sub> dynamics at ADEM WKBB5 station.....	B-19
Figure B-2.2.10	N-NO <sub>3</sub> dynamics at ADEM WKBB6 station.....	B-19



Figure B-3.1	P-PO4 dynamics at NERRS Middle Bay (MB) station.....	B-21
Figure B-3.2	P-PO4 dynamics at NERRS Weeks Bay (WB) station .....	B-22
Figure B-3.3	P-PO4 dynamics at NERRS Magnolia River (MR) station .....	B-22
Figure B-3.4	P-PO4 dynamics at NERRS Fish River (FR) station .....	B-23
Figure B-3.5	TP dynamics at ADEM WB1 station .....	B-23
Figure B-3.6	TP dynamics at ADEM WKBB1 station.....	B-24
Figure B-3.7	TP dynamics at ADEM WKBB2 station.....	B-24
Figure B-3.8	TP dynamics at ADEM WKBB4 station.....	B-25
Figure B-3.9	TP dynamics at ADEM WKBB5 station.....	B-25
Figure B-3.10	TP dynamics at ADEM WKBB6 station.....	B-26
Figure B-4.1	Dissolved oxygen dynamics at NERRS Middle Bay (MB) station.....	B-28
Figure B-4.2	Dissolved oxygen dynamics at NERRS Weeks Bay (WB) station .....	B-29
Figure B-4.3	Dissolved oxygen dynamics at NERRS Magnolia River (MR) station .....	B-29
Figure B-4.4	Dissolved oxygen dynamics at NERRS Fish River (FR) station .....	B-30
Figure B-4.5	Dissolved oxygen dynamics at ADEM WKBB1 station.....	B-30
Figure B-4.6	Dissolved oxygen dynamics at ADEM WKBB2 station.....	B-31
Figure B-4.7	Dissolved oxygen dynamics at ADEM WKBB4 station.....	B-31
Figure B-4.8	Dissolved oxygen dynamics at ADEM WKBB5 station.....	B-32
Figure B-4.9	Dissolved oxygen dynamics at ADEM WKBB6 station.....	B-32
Figure B-4.10	Dissolved oxygen dynamics at ADEM WB1 station .....	B-33
Figure B-5.1	CBOD dynamics at ADEM WKBB1 station .....	B-35
Figure B-5.2	CBOD dynamics at ADEM WKBB2 station .....	B-35
Figure B-5.3	CBOD dynamics at ADEM WKBB4 station .....	B-36
Figure B-5.4	CBOD dynamics at ADEM WKBB5 station .....	B-36
Figure B-5.5	CBOD dynamics at ADEM WKBB6 station .....	B-37
Figure B-5.6	CBOD dynamics at ADEM WB1 station.....	B-37
Figure B-6.1	TSS dynamics at ADEM WKBB1 station .....	B-39
Figure B-6.2	TSS dynamics at ADEM WKBB2 station .....	B-39
Figure B-6.3	TSS dynamics at ADEM WKBB4 station .....	B-40
Figure B-6.4	TSS dynamics at ADEM WKBB5 station .....	B-40
Figure B-6.5	TSS dynamics at ADEM WKBB6 station .....	B-41
Figure B-6.6	TSS dynamics at ADEM WB1 station.....	B-41

## Tables

Table B-1.1	Comparisons of simulations and measurements of Chlorophyll <i>a</i> at NERRS monitoring stations: years 2008-2011 .....	B-5
Table B-1.2	Quality of Chlorophyll <i>a</i> calibration and validation .....	B-5
Table B-2.1	Comparisons of simulations and measurements of mineral nitrogen at NERRS monitoring stations: years 2008-2011 .....	B-8
Table B-2.2	Comparisons of simulations and measurements of mineral nitrogen at ADEM monitoring stations: year 2011 .....	B-8
Table B-2.3	Quality of mineral nitrogen calibration and validation .....	B-9
Table B-3.1	Comparisons of simulations and measurements of P-PO <sub>4</sub> at NERRS monitoring stations: years 2008-2011 .....	B-20
Table B-3.2	Comparisons of simulations and measurements of TP at ADEM monitoring stations: year 2011.....	B-20
Table B-3.3	Quality of phosphorus compounds calibration and validation.....	B-21
Table B-4.1	Comparisons of simulations and measurements of Dissolved oxygen at NERRS monitoring stations: years 2008-2011 .....	B-27
Table B-4.2	Comparisons of simulations and measurements of Dissolved oxygen at ADEM monitoring stations: year 2011 .....	B-27
Table B-4.3	Quality of dissolved oxygen calibration and validation.....	B-28
Table B-5.1	Comparisons of simulations and measurements of CBOD at ADEM monitoring stations, Weeks Bay AL: year 2011 .....	B-34
Table B-5.2	Quality of CBOD calibration and validation.....	B-34
Table B-6.1	Comparisons of simulations and measurements of TSS at ADEM monitoring stations, Weeks Bay AL: year 2011 .....	B-38
Table B-6.2	Quality of CBOD calibration and validation.....	B-38

## B-1 Dynamics of Chlorophyll *a*

Table B-1.1 and Figures B-1.1 through B-1.4 represent the numerical and visual comparisons of Chlorophyll *a* simulations in surface layer of the Weeks Bay WASP model with the available NERRS monitoring data that were collected during years 2008-2011.

The numerical metrics of correspondence of Chlorophyll *a* simulations vs. measurements are presented in Tables B-1.1

**Table B-1.1 Comparisons of simulations and measurements of Chlorophyll *a* at NERRS monitoring stations: years 2008-2011**

Station	Simulations (mg/l)		Measurements (mg/l)	Deviation (%)	
	Mean Surface	Mean Bottom	Mean	Surface	Bottom
Mid-Bay	31	22	38	-18	-42
Weeks Bay	30	22	33	-9	-33
Magnolia River	30	26	36	-17	-28
Fish River	34	28	28	21	0

The deviations of surface and bottom Chlorophyll *a* are in a range of 9-21% and 0-42% correspondently. The tables demonstrate the significant Chlorophyll *a* stratification of Weeks Bay.

The comparisons of the deviation values with the calibration quality rating table (Main Report) allow estimating the calibrated EFDC model performance at locations of the bay's monitoring station with grades that are presented in Table B-1.2

**Table B-1.2 Quality of Chlorophyll *a* calibration and validation**

Station	Chlorophyll <i>a</i>
Mid-Bay	Very Good
Weeks Bay	Very Good
Magnolia River	Very Good
Fish River	Very Good

The figures B-1.1 through B-1.10 accurately represent the ranges and seasonal trends of Chlorophyll *a* dynamics in different parts of the bay.

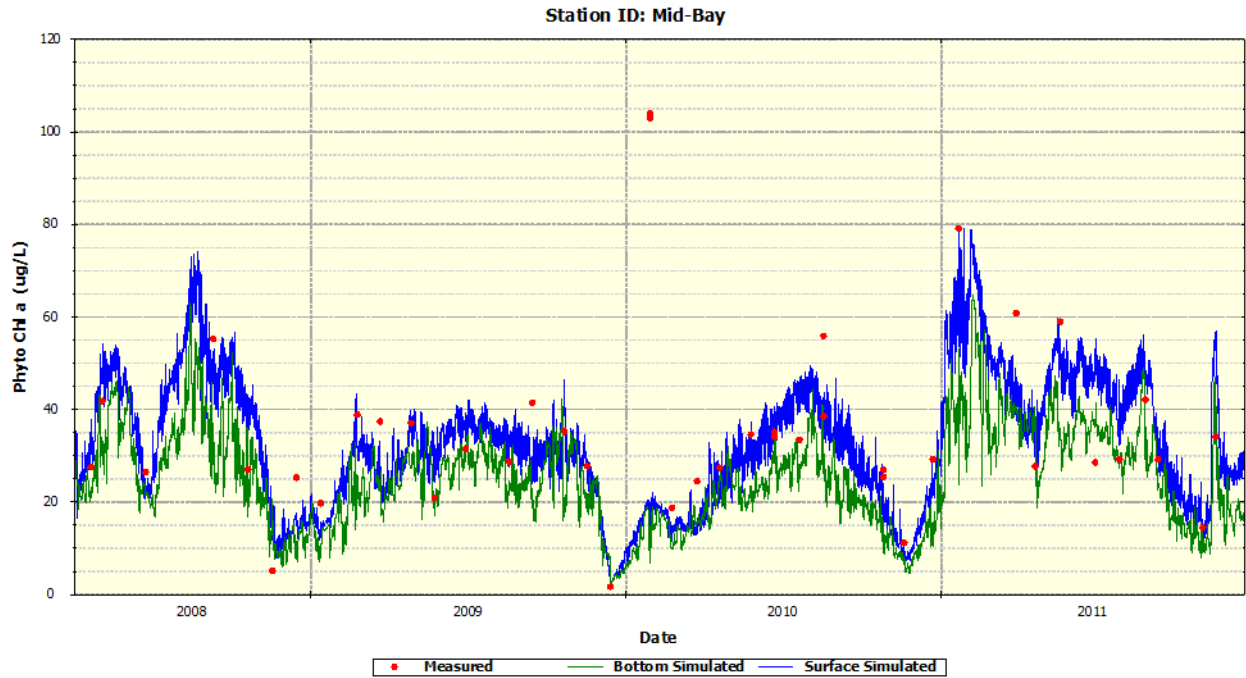

Figure B-1.1 Chlorophyll *a* dynamics at NERRS Middle Bay (MB) station

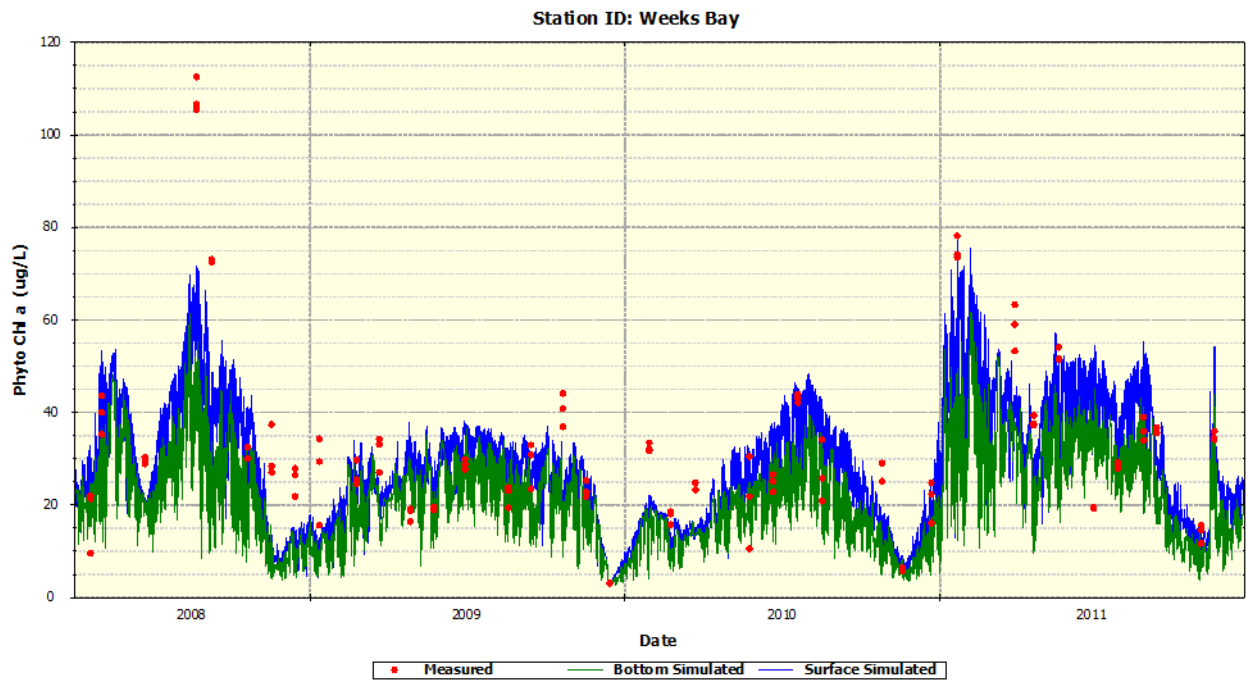

Figure B-1.2 Chlorophyll *a* dynamics at NERRS Weeks Bay (WB) station

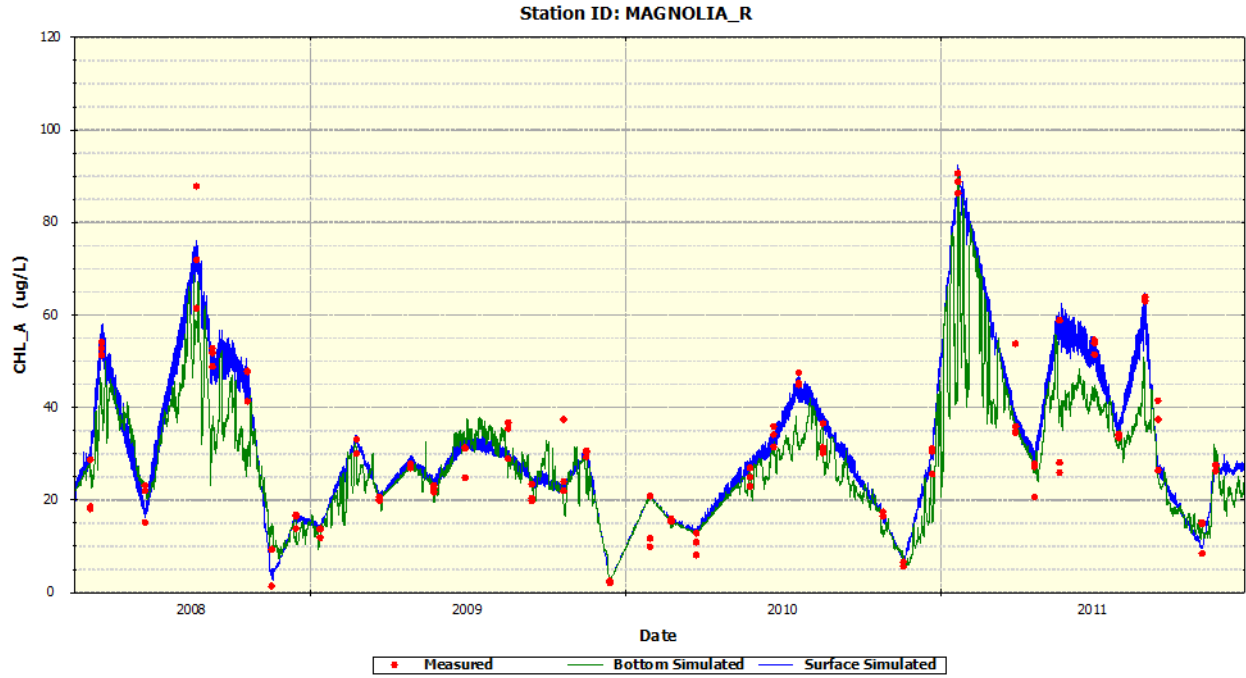

Figure B-1.3 Chlorophyll *a* dynamics at NERRS Magnolia River (MR) station

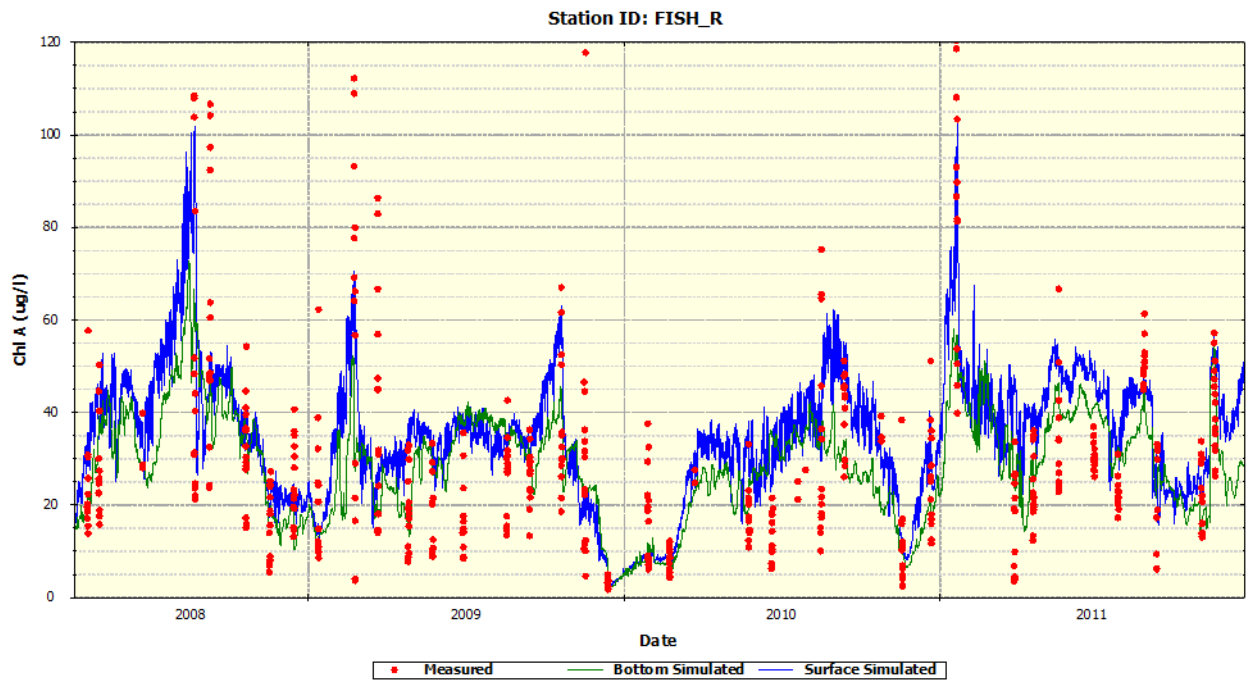

Figure B-1.4 Chlorophyll *a* dynamics at NERRS Fish River (FR) station

## B-2 Dynamics of Mineral Nitrogen

Tables B-2.1 and B-2.2, and Figures B-2.1.1 through B-2.1.10 for N-NH<sub>3</sub>, Figures B-2.2.1 through B-2.2.10 for N-NO<sub>3</sub> represent the numerical and visual comparisons of simulations of mineral nitrogen and its compounds in surface in bottom layers of the Weeks Bay WASP model with the available NERRS and ADEM monitoring data that were collected during years 2008-2011.

The numerical metrics of correspondence of salinity simulations vs. measurements are presented in Tables B-2.1 and B-2.2.

**Table B-2.1 Comparisons of simulations and measurements of mineral nitrogen at NERRS monitoring stations: years 2008-2011**

Station	Simulations (mg/l)		Measurements (mg/l)	Deviation (%)	
	Mean Surface	Mean Bottom	Mean	Surface	Bottom
Mid-Bay	0.343	0.287	0.215	60	33
Weeks Bay	0.373	0.307	0.217	72	41
Magnolia River	0.466	0.4	0.507	-8	-21
Fish River	0.353	0.308	0.51	-31	-40

**Table B-2.2 Comparisons of simulations and measurements of mineral nitrogen at ADEM monitoring stations: year 2011**

Station	Simulations (mg/l)		Measurements (mg/l)	Deviation (%)	
	Mean Surface	Mean Bottom	Mean	Surface	Bottom
WB1	0.137	0.14	0.256	-46	-45
WKBB1	0.108	0.098	0.064	69	53
WKBB2	0.124	0.122	0.109	14	12
WKBB4	0.138	0.106	0.064	116	66
WKBB5	0.101	0.101	0.084	20	20
WKBB6	0.11	0.115	0.071	55	62

The deviations of bottom and surface salinity are in a range of 14-116% and 12-62% correspondently.

The comparisons of the deviation values with the calibration quality rating table (Main Report) allow estimating the calibrated EFDC model performance at locations of the bay's monitoring station with grades that are presented in Table B-3.3

**Table B-2.3 Quality of mineral nitrogen calibration and validation**

Station	Mineral Nitrogen
MB	Good
WB1	Good
MR	Very Good
FR	Good
WB1	Fair
WKBB1	Fair
WKBB2	Very Good
WKBB4	Poor
WKBB5	Very Good
WKBB6	Fair

The figures B-2.1.1 through B-2.1.10 and B-2.2.1 through B-2.2.10 close enough display the ranges and general trends of N-NH<sub>3</sub> and N-NO<sub>3</sub> dynamics in different parts of the bay.

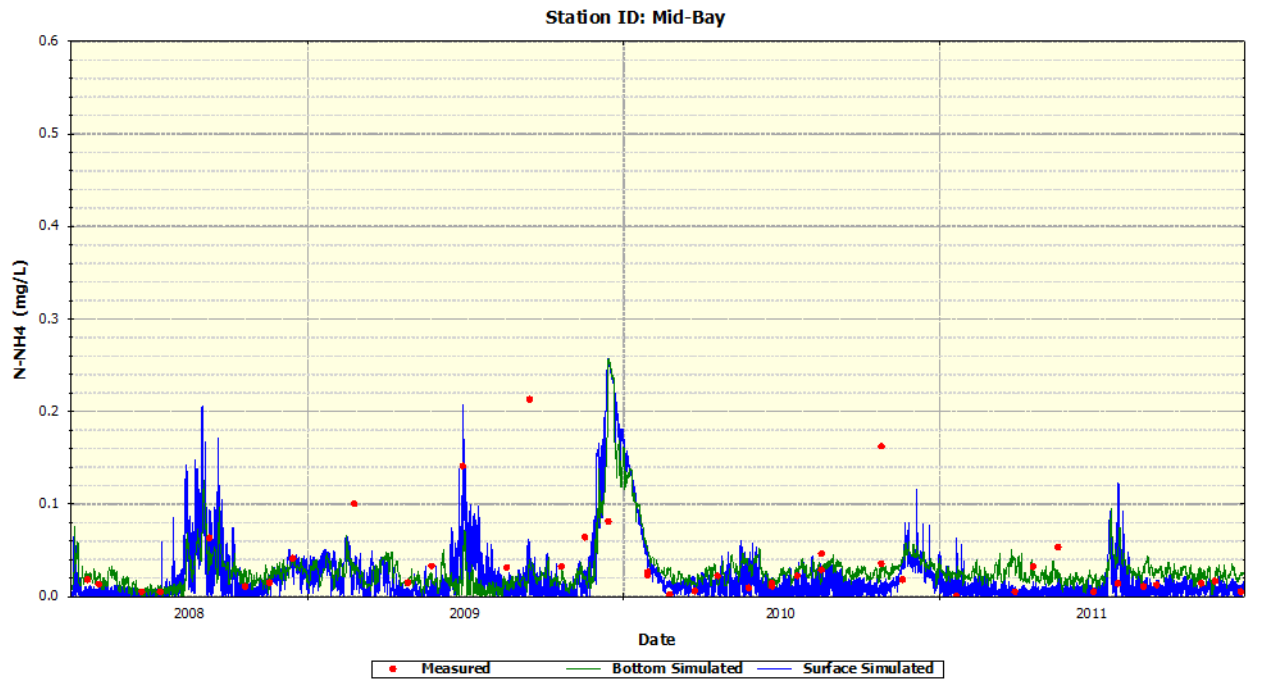

**Figure B-2.1.1 N-NH<sub>3</sub> dynamics at NERRS Middle Bay (MB) station**

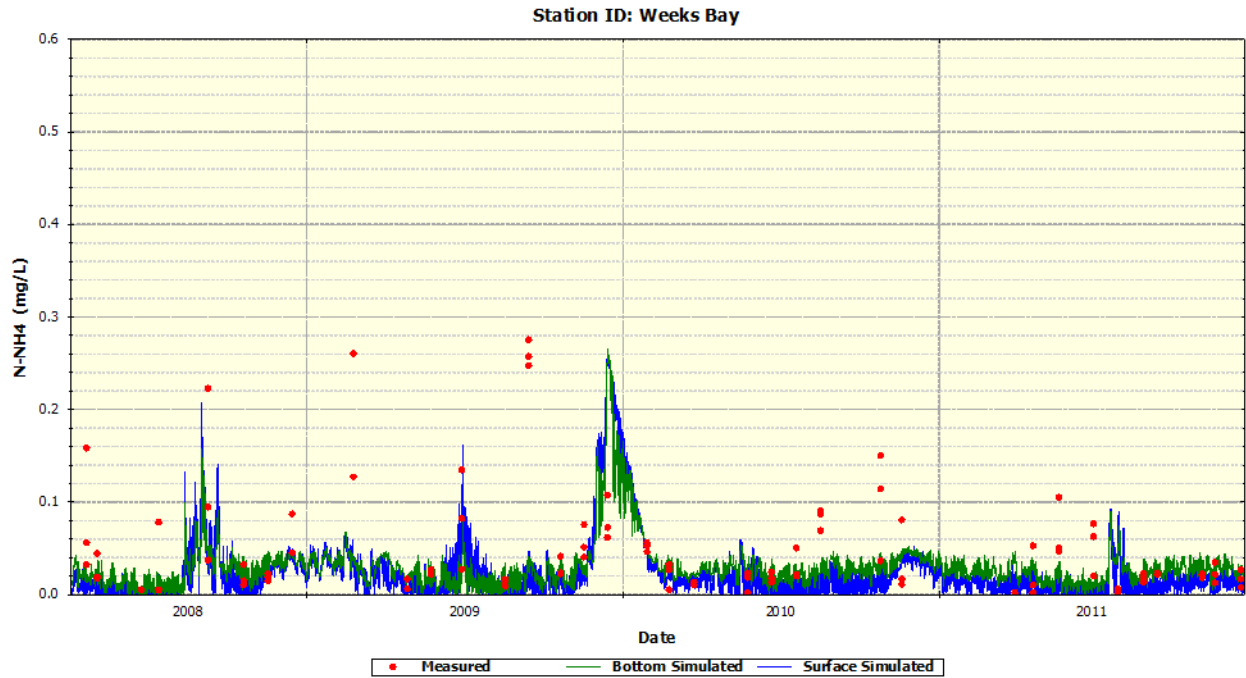

Figure B-2.1.2 N-NH<sub>3</sub> dynamics at NERRS Weeks Bay (WB) station

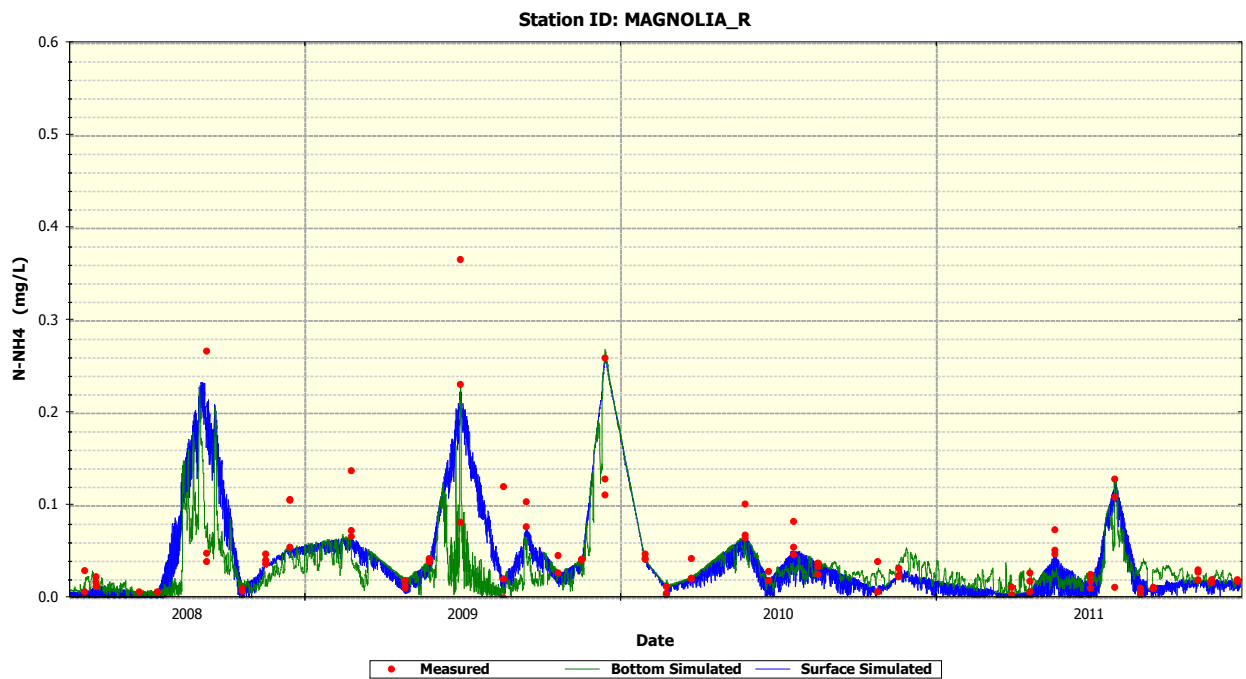

Figure B-2.1.3 N-NH<sub>3</sub> dynamics at NERRS Magnolia River (MR) station



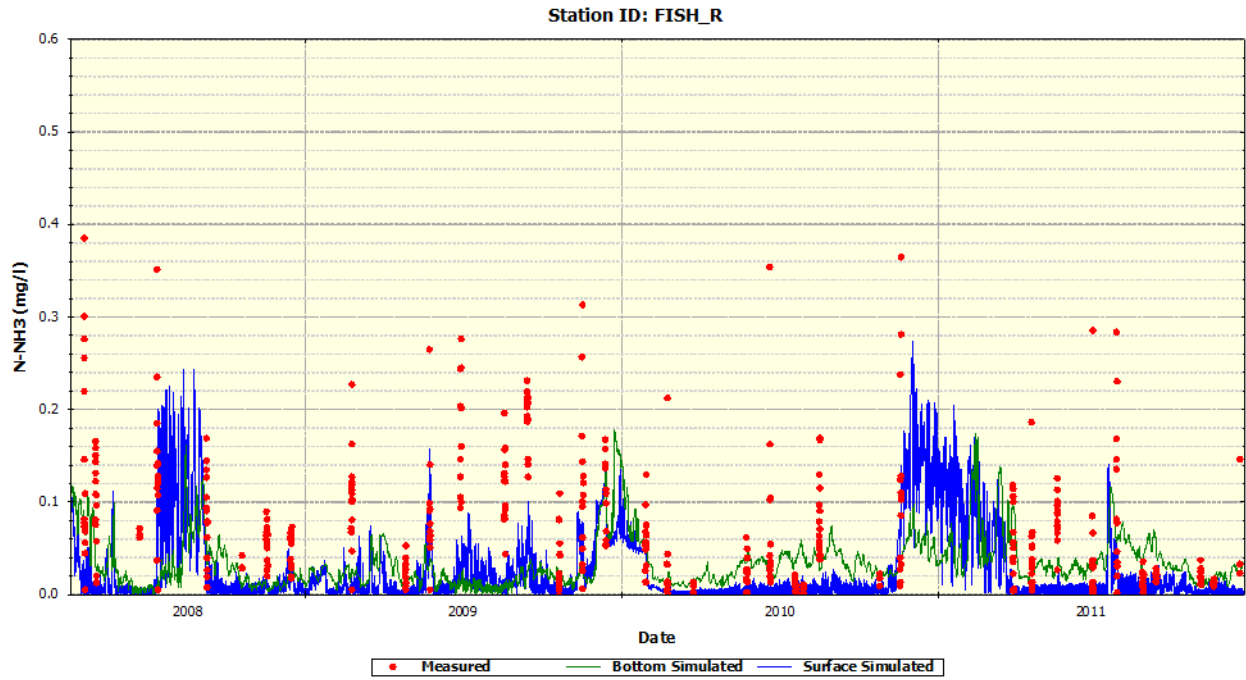

Figure B-2.1.4 N-NH3 dynamics at NERRS Fish River (FR) station

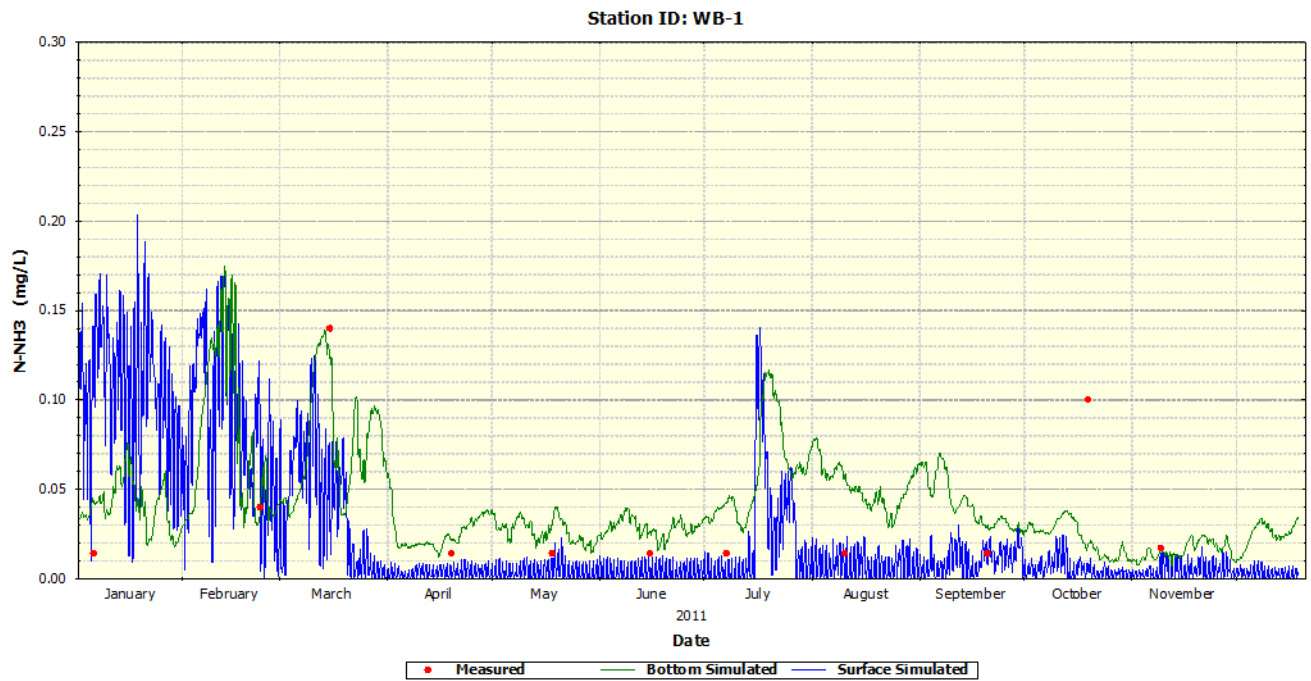

Figure B-2.1.5 N-NH3 dynamics at ADEM WB1 station

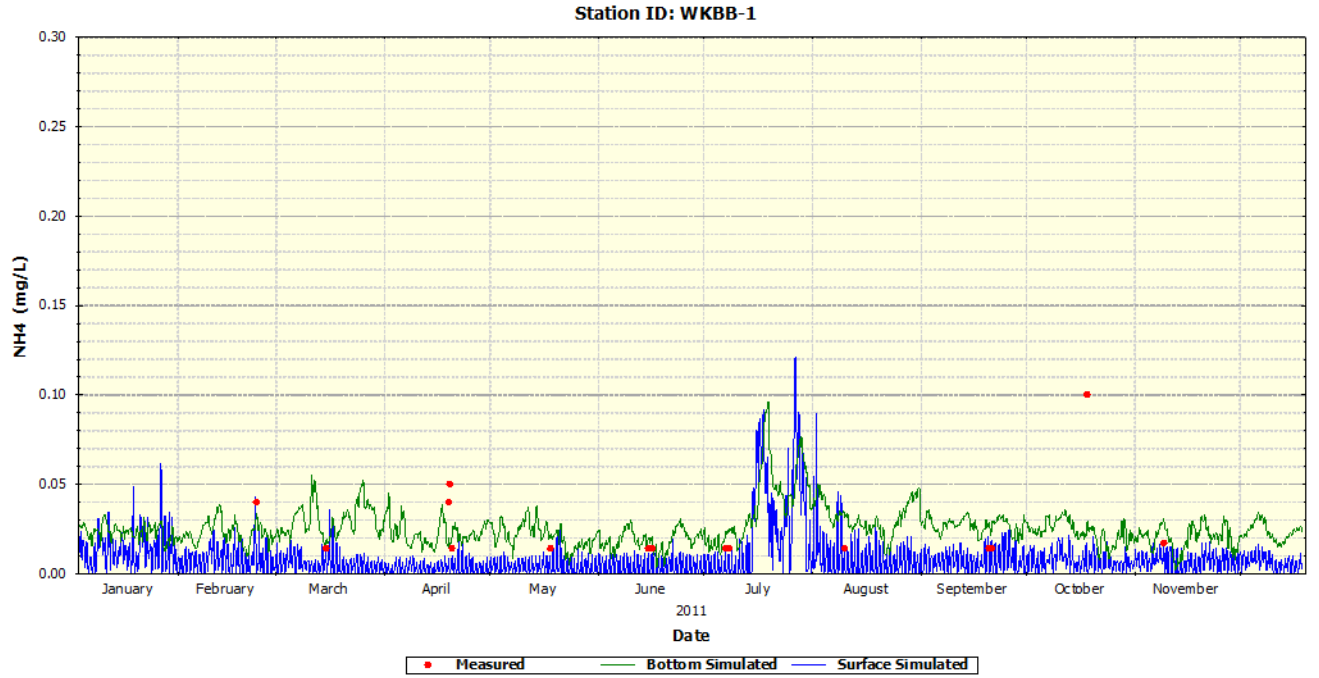

Figure B-2.1.6 N-NH<sub>3</sub> dynamics at ADEM WKBB1 station

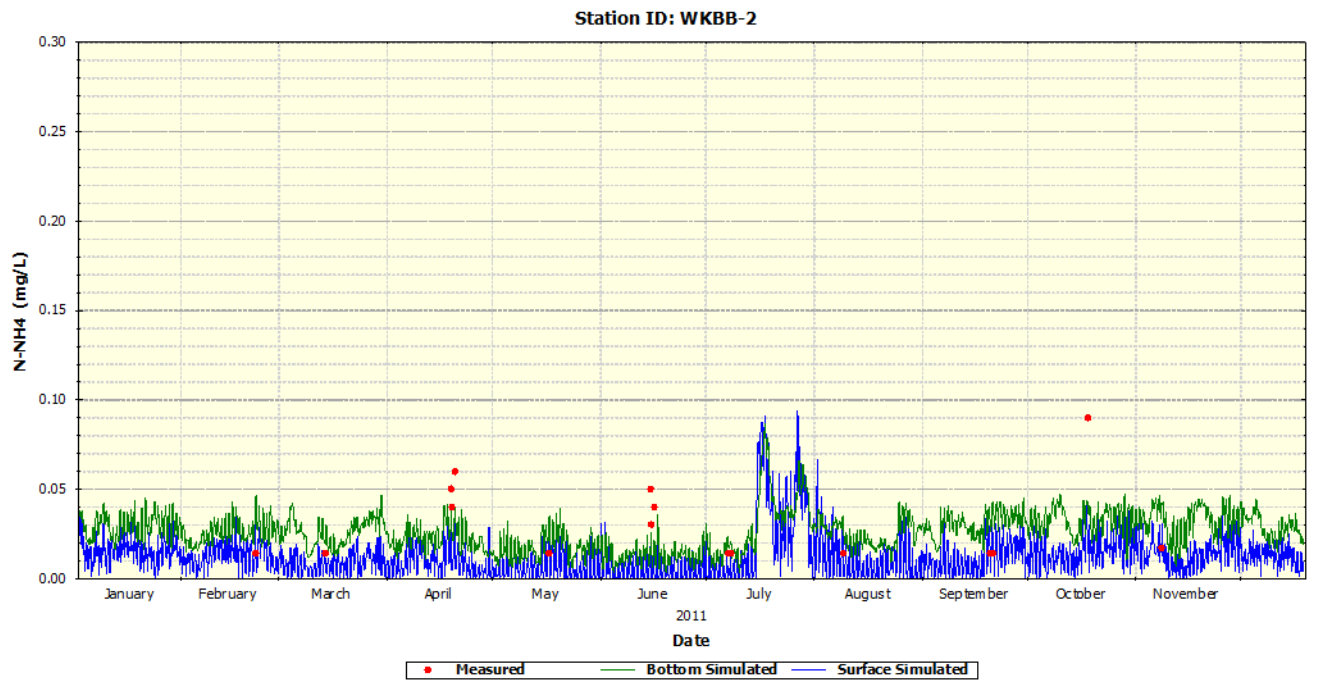

Figure B-2.1.7 N-NH<sub>3</sub> dynamics at ADEM WKBB2 station

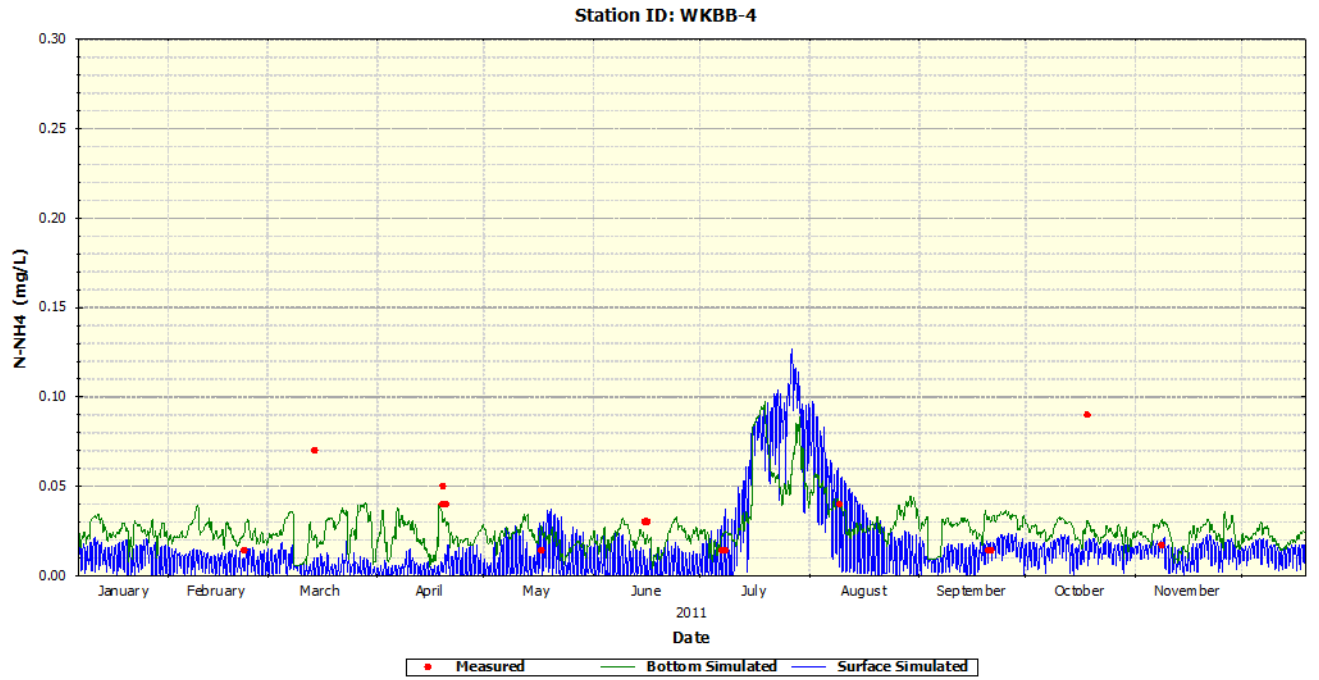

Figure B-2.1.8 N-NH<sub>3</sub> dynamics at ADEM WKBB4 station

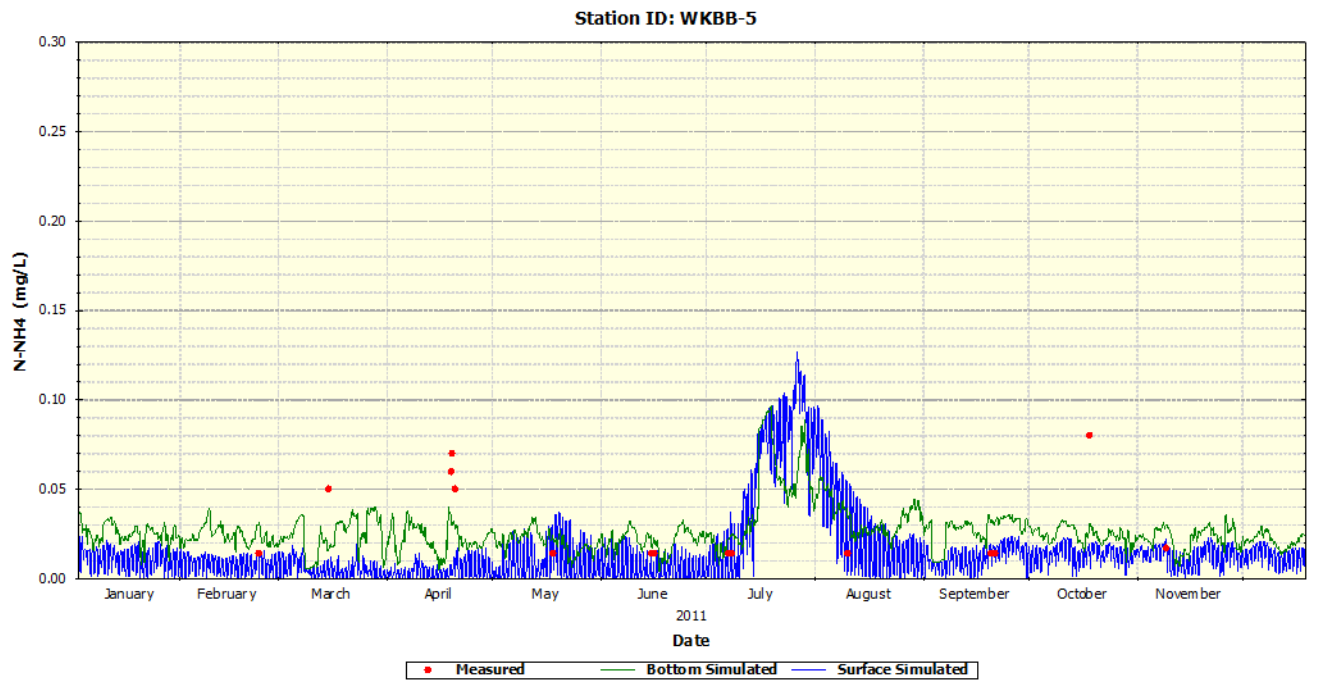
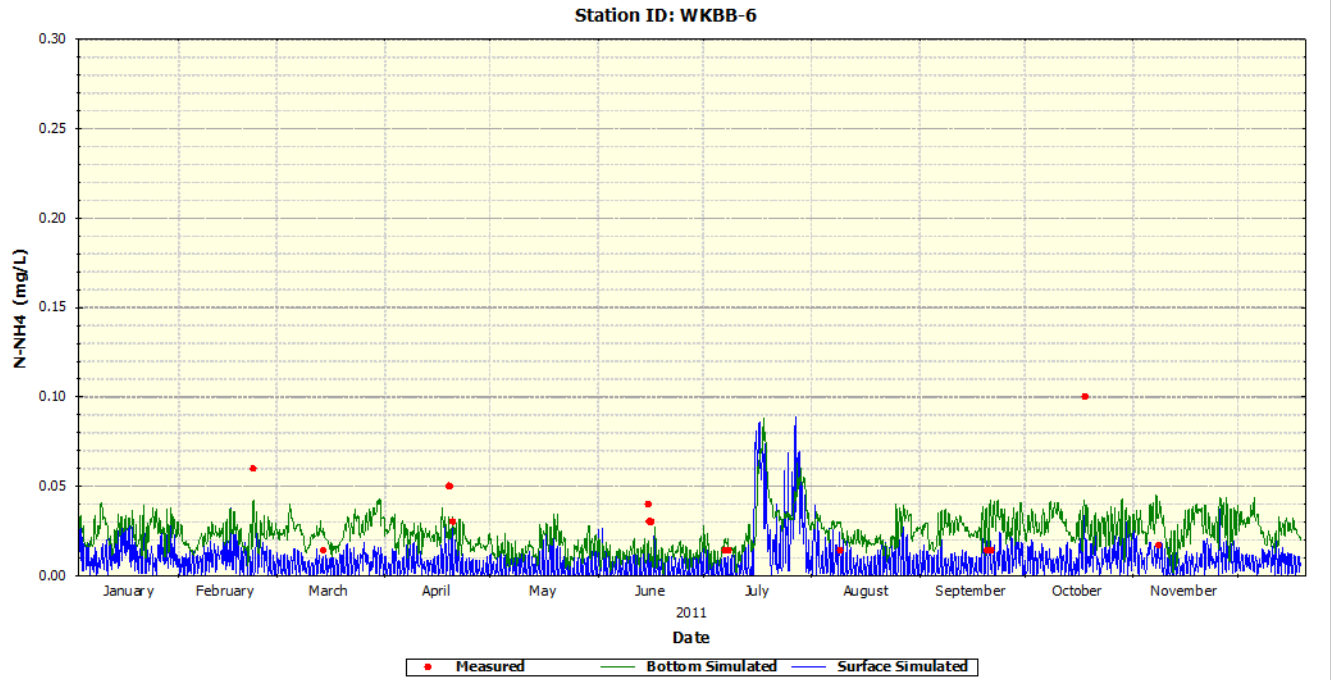

Figure B-2.1.9 N-NH<sub>3</sub> dynamics at ADEM WKBB5 station



**Figure B-2.1.10**      **N-NH<sub>3</sub> dynamics at ADEM WKBB6 station**

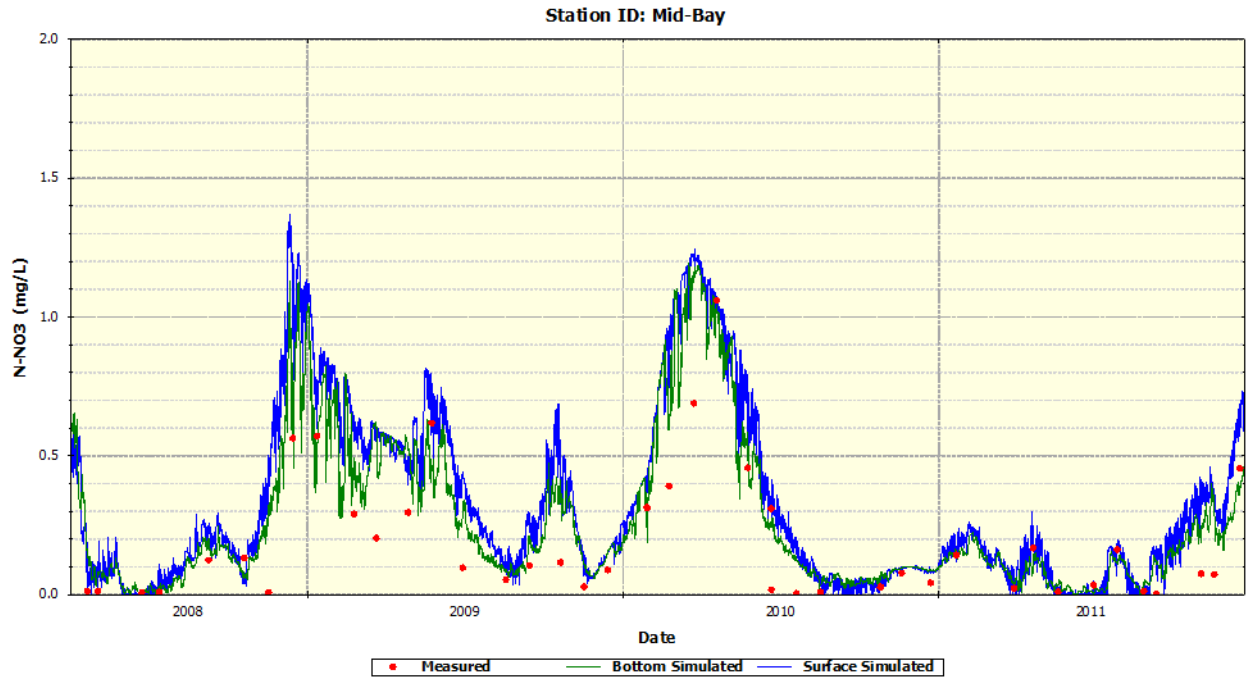

Figure B-2.2.1 N-NO3 dynamics at NERRS Middle Bay (MB) station

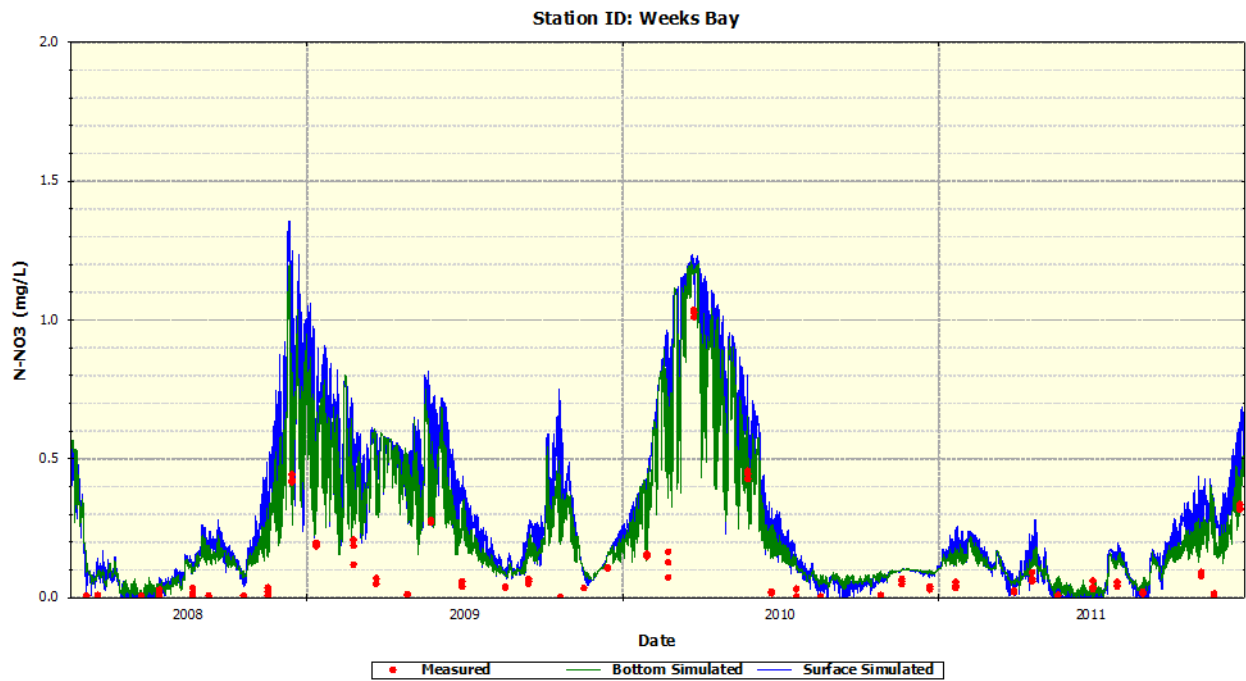

Figure B-2.2.2 N-NO3 dynamics at NERRS Weeks Bay (WB) station

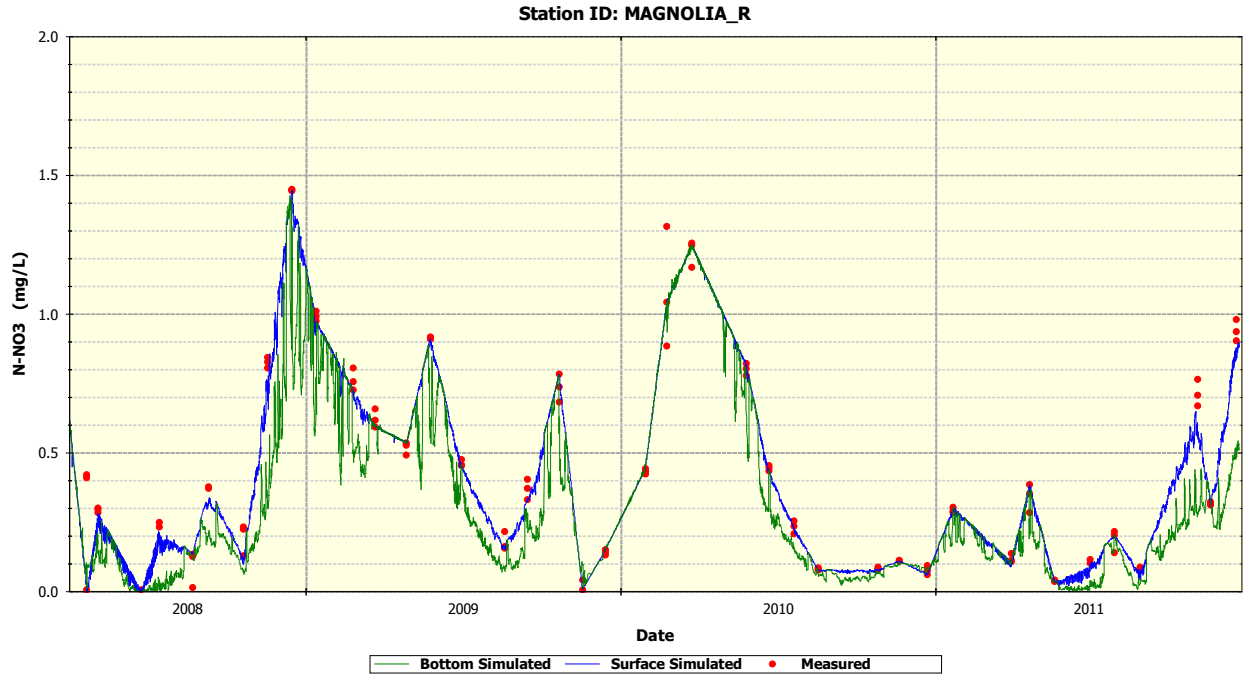

Figure B-2.2.3 N-NO3 dynamics at NERRS Magnolia River (MR) station

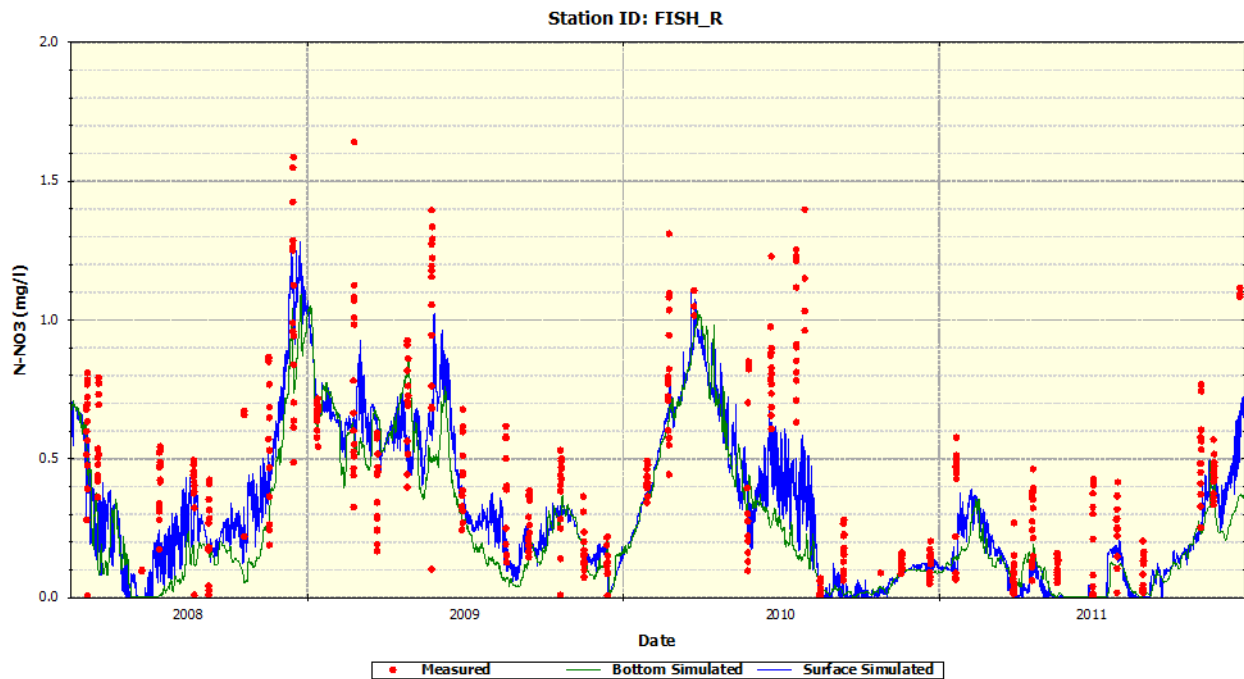
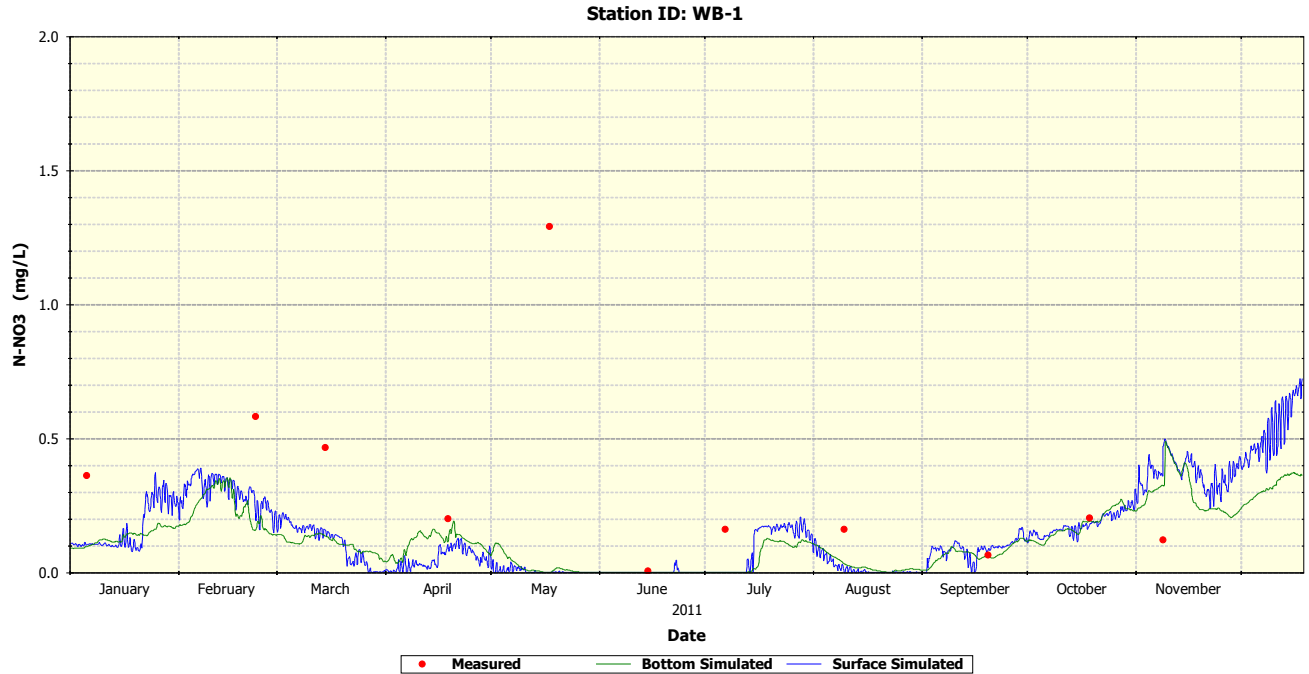
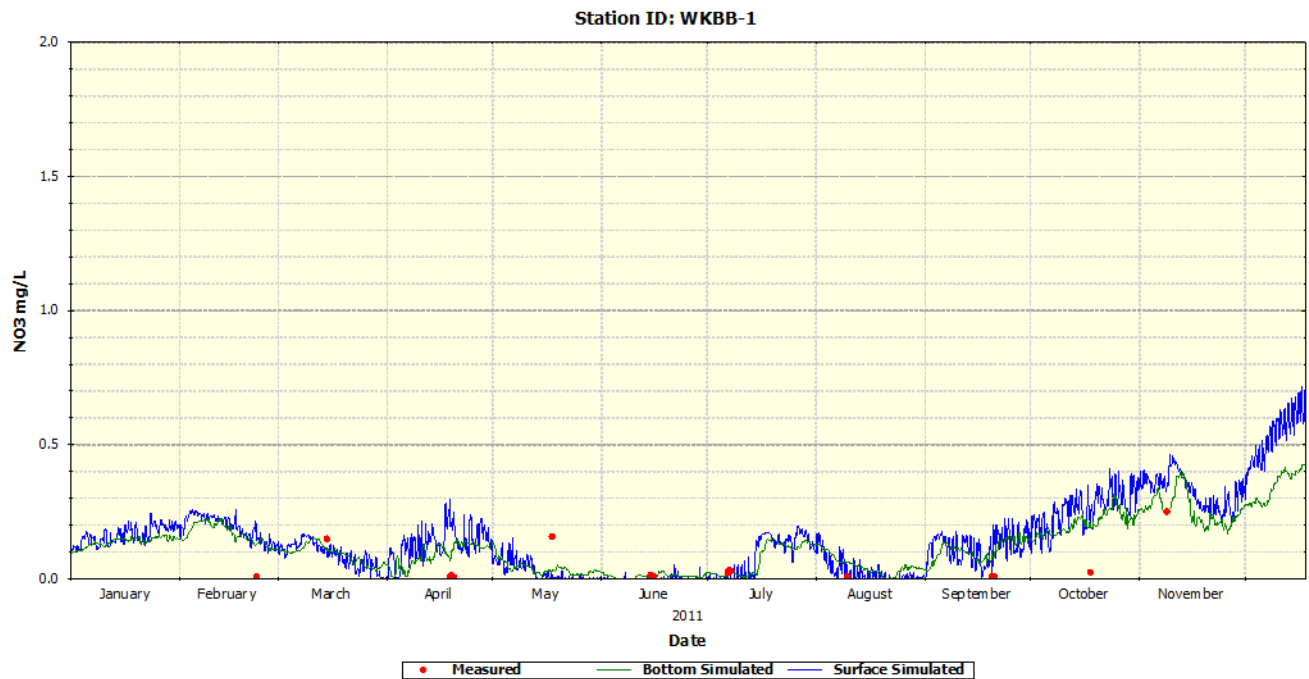

Figure B-2.2.4 N-NO3 dynamics at NERRS Fish River (FR) station



**Figure B-2.2.5** N-NO3 dynamics at ADEM WB1 station



**Figure B-2.2.6** N-NO3 dynamics at ADEM WKBB1 station

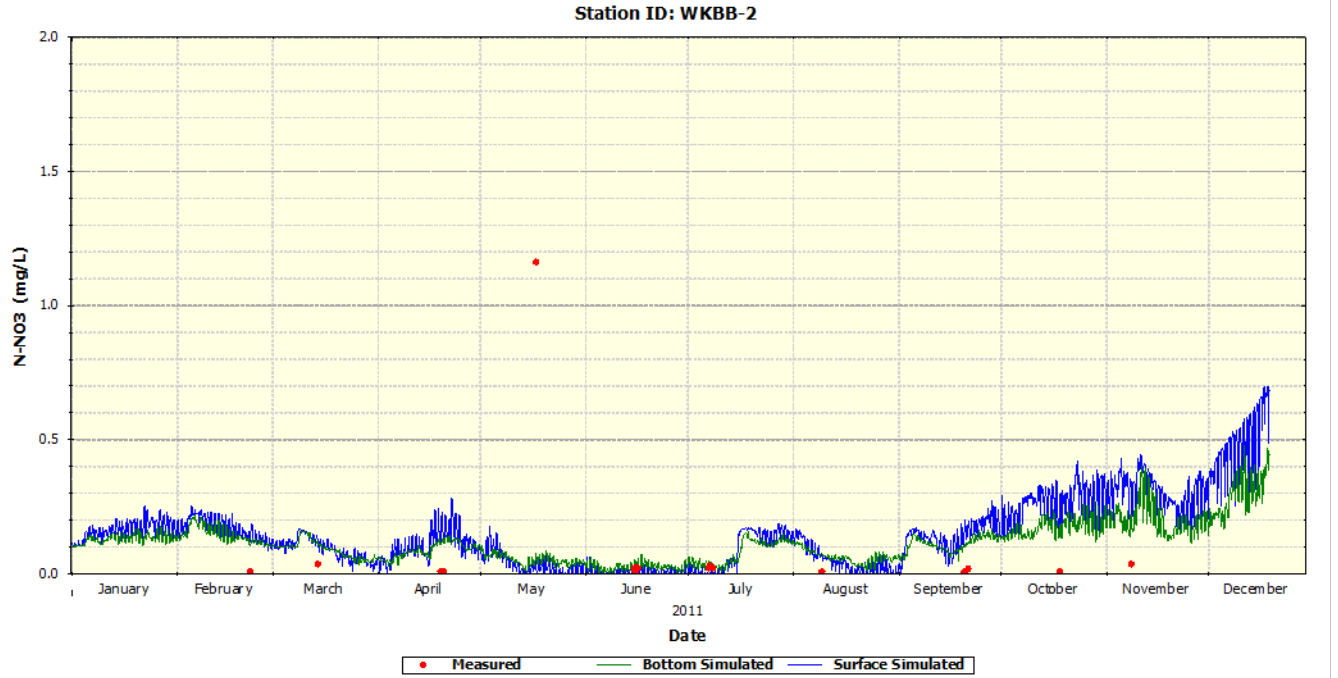

Figure B-2.2.7 N-NO<sub>3</sub> dynamics at ADEM WKBB2 station

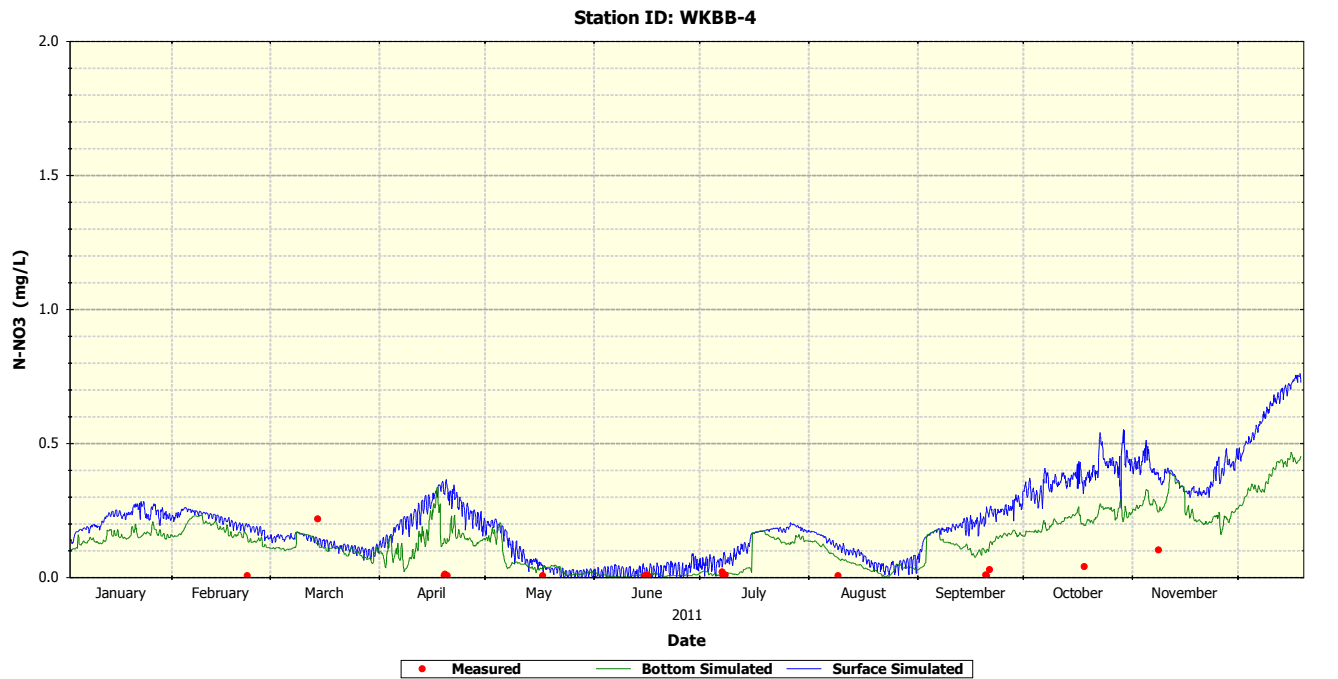
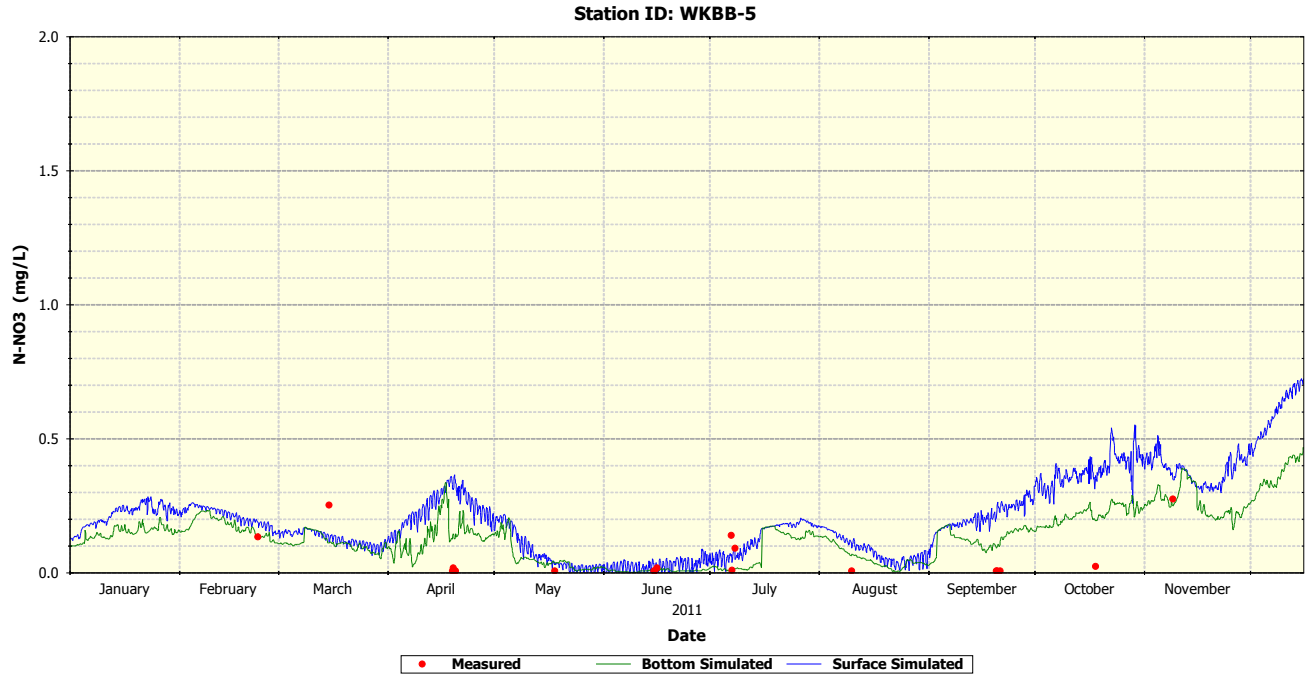
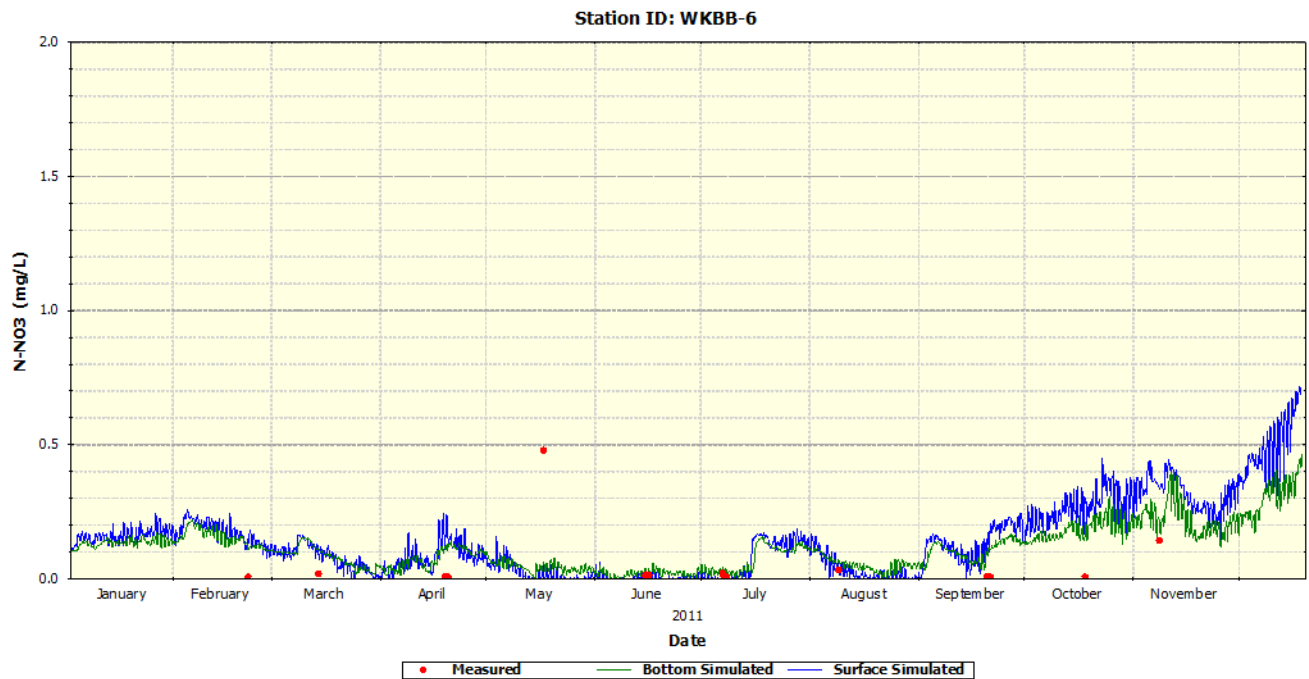

Figure B-2.2.8 N-NO<sub>3</sub> dynamics at ADEM WKBB4 station





**Figure B-2.2.9**      **N-NO<sub>3</sub> dynamics at ADEM WKBB5 station**



**Figure B-2.2.10**      **N-NO<sub>3</sub> dynamics at ADEM WKBB6 station**

## B-3 Dynamics of Mineral and Total Phosphorus

Tables B-3.1 and B-3.2, and Figures B-3.1 through B-3.10 represent the numerical and visual comparisons of P-PO<sub>4</sub> and TP simulations in surface and bottom layers of the Weeks Bay WASP model with the available NERRS and ADEM monitoring data that were collected during years 2008-2011.

The numerical metrics of correspondence of the phosphorus compounds simulations vs. measurements are presented in Tables B-3.1 and B-3.2.

**Table B-3.1 Comparisons of simulations and measurements of P-PO<sub>4</sub> at NERRS monitoring stations: years 2008-2011**

Station	Simulations (mg/l)		Measurements (mg/l)	Deviation (%)	
	Mean Surface	Mean Bottom	Mean	Surface	Bottom
Mid-Bay	0.005	0.009	0.006	-17	50
Weeks Bay	0.005	0.008	0.006	-17	33
Magnolia River	0.006	0.007	0.006	0	17
Fish River	0.004	0.01	0.004	0	150

**Table B-3.2 Comparisons of simulations and measurements of TP at ADEM monitoring stations: year 2011**

Station	Simulations (mg/l)		Measurements (mg/l)	Deviation (%)	
	Mean Surface	Mean Bottom	Mean	Surface	Bottom
WB1	0.072	0.07	0.08	-10	-13
WKBB1	0.072	0.067	0.081	-11	-17
WKBB2	0.065	0.057	0.079	-18	-28
WKBB4	0.075	0.067	0.077	-3	-13
WKBB5	0.1	0.07	0.074	35	-5
WKBB6	0.067	0.059	0.084	-20	-30

The deviations of bottom and surface P-PO<sub>4</sub> (Table B-3.1) are in a range of 50-150% and 0-17% correspondently. The deviations of bottom and surface TP (Table B-3.2) are in a range of 5-30% and 3-35% correspondently.

The comparisons of the deviation values with the calibration quality rating table (Main Report) allow estimating the calibrated WASP model performance at locations of the bay's monitoring station with grades that are presented in Table B-1.3. Assigning the quality rating to phosphorus compounds calibration the following assumption has been made. If measurements and simulations are below the analytical detection limit (0.02 for P-PO<sub>4</sub>, as example) the simulations were estimated as Very Good.

**Table B-3.3 Quality of phosphorus compounds calibration and validation**

Station	P-PO4 / TP
MB	Very Good
WB1	Very Good
MR	Very Good
FR	Very Good
WB1	Very Good
WKBB1	Very Good
WKBB2	Very Good
WKBB4	Very Good
WKBB5	Very Good
WKBB6	Very Good

The figures B-3.1 through B-3.10 accurately display the ranges and general trends of P-PO4 and TP dynamics in different parts of the bay.

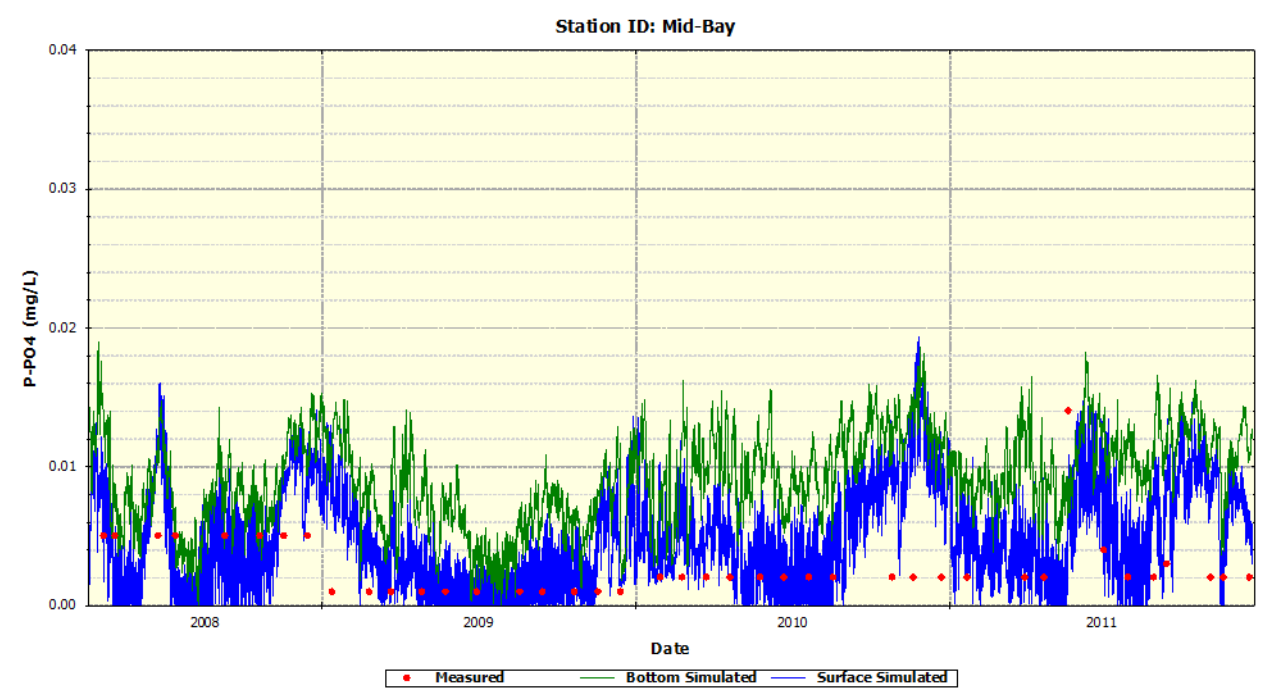

**Figure B-3.1 P-PO4 dynamics at NERRS Middle Bay (MB) station**

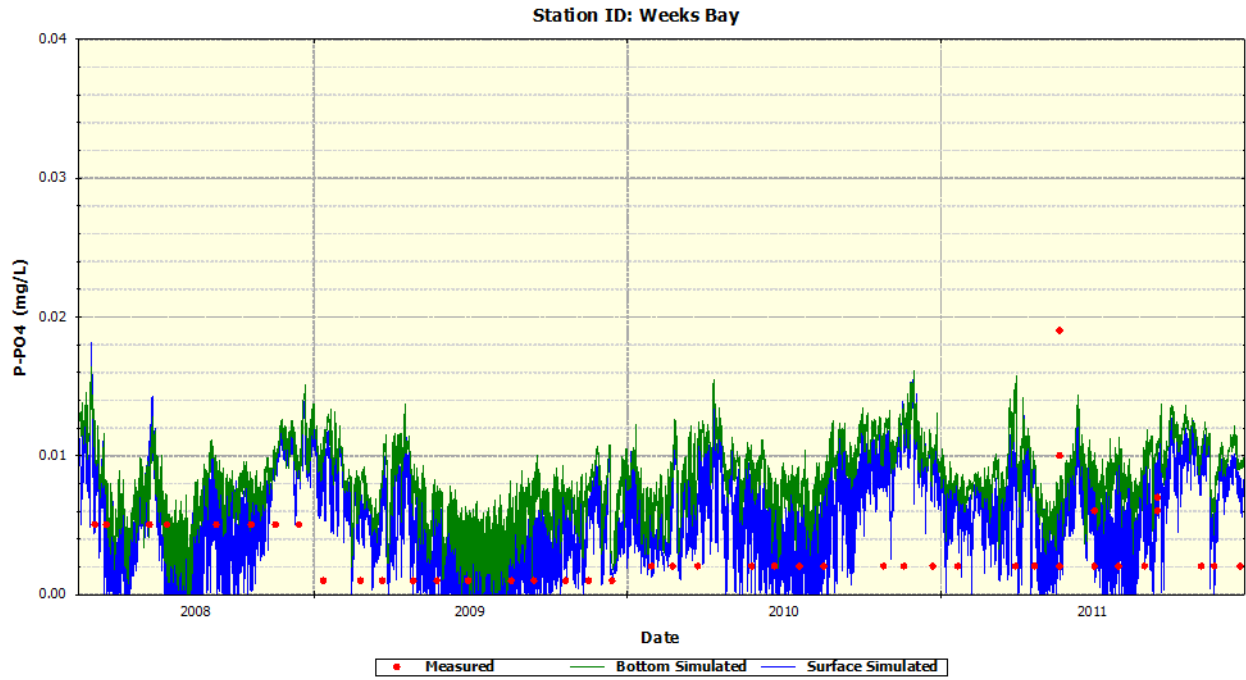

Figure B-3.2 P-PO4 dynamics at NERRS Weeks Bay (WB) station

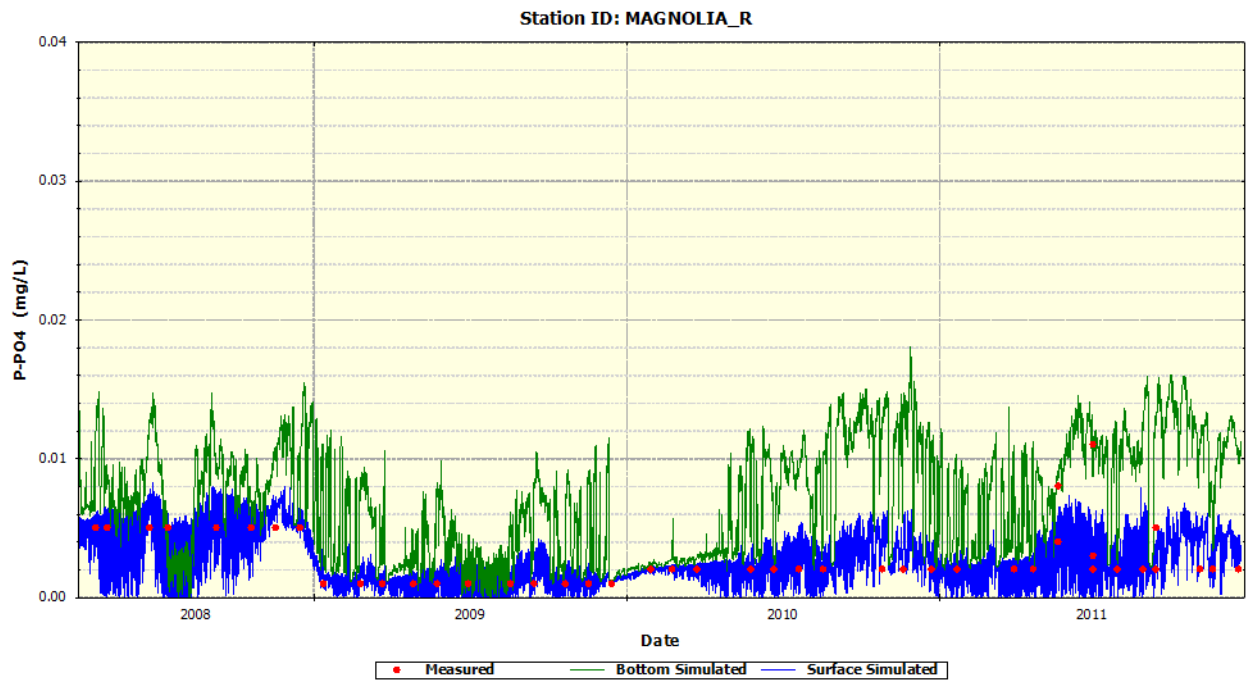

Figure B-3.3 P-PO4 dynamics at NERRS Magnolia River (MR) station

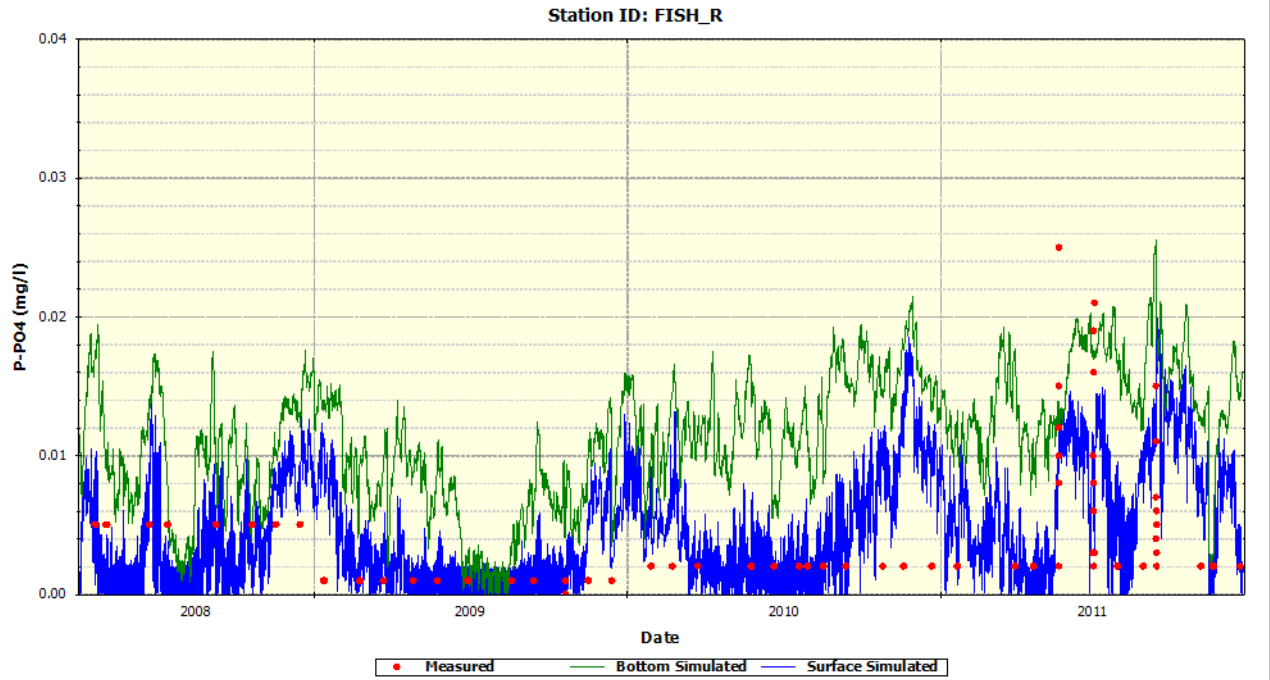

Figure B-3.4 P-PO4 dynamics at NERRS Fish River (FR) station

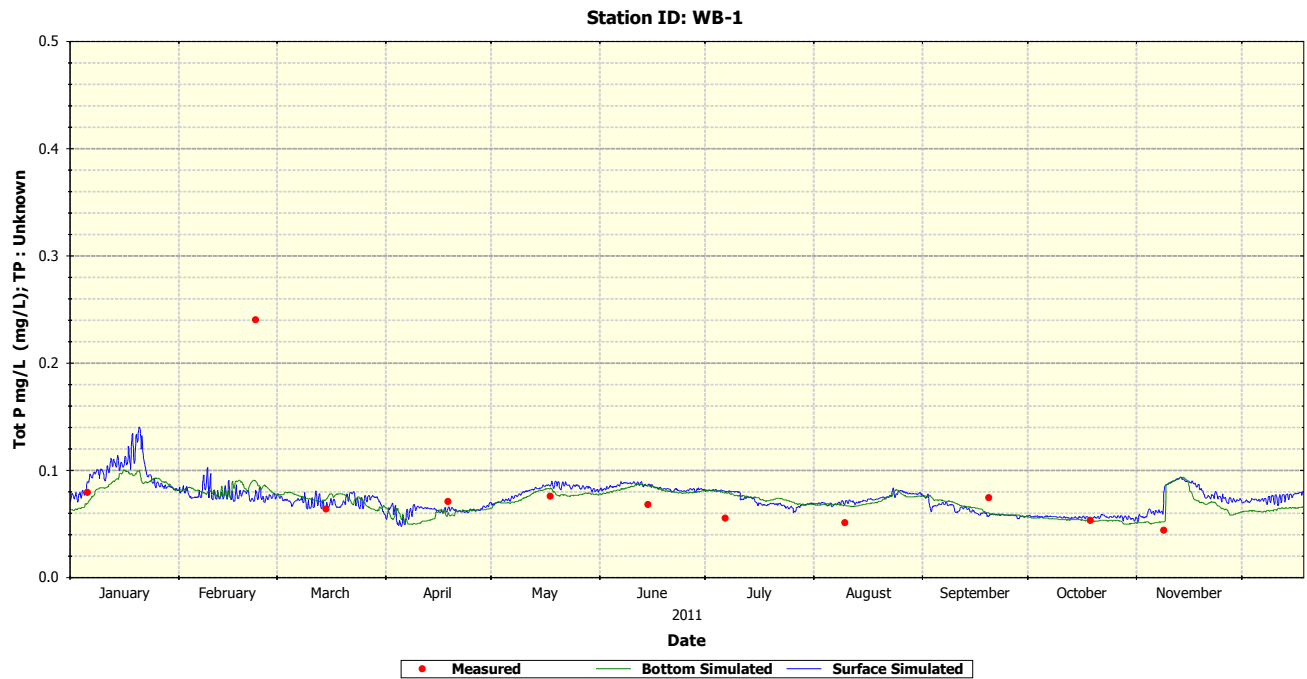
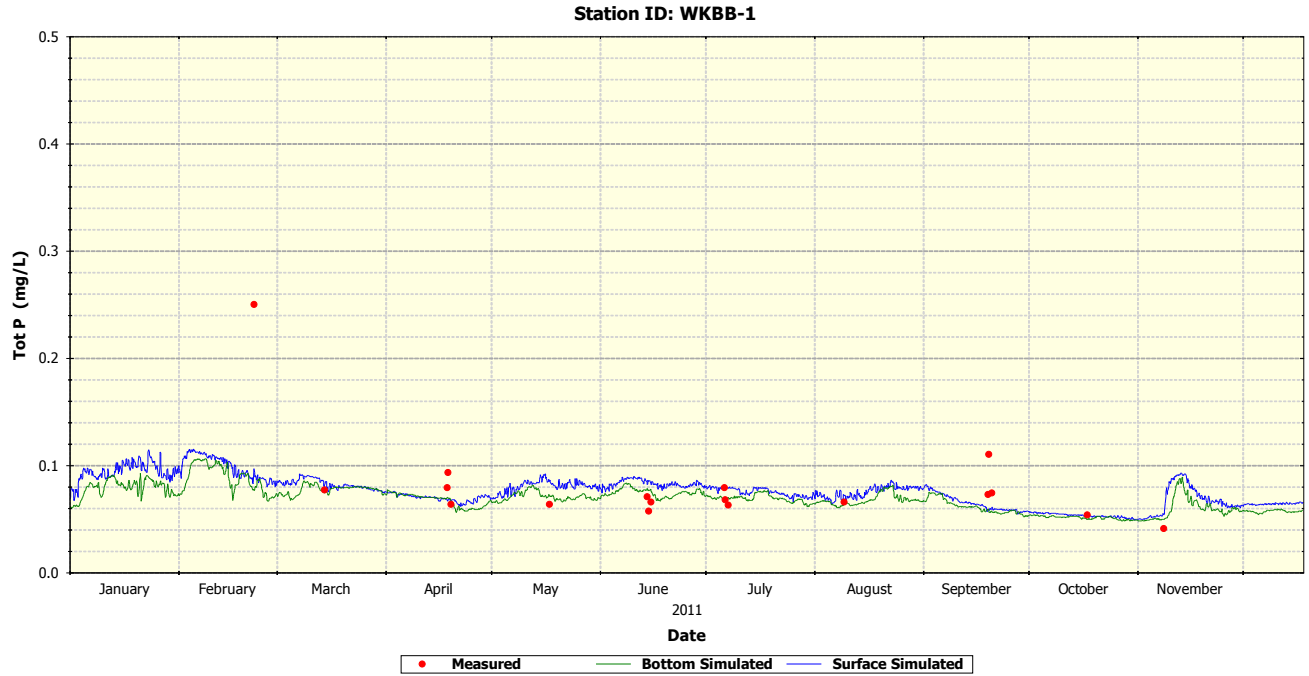
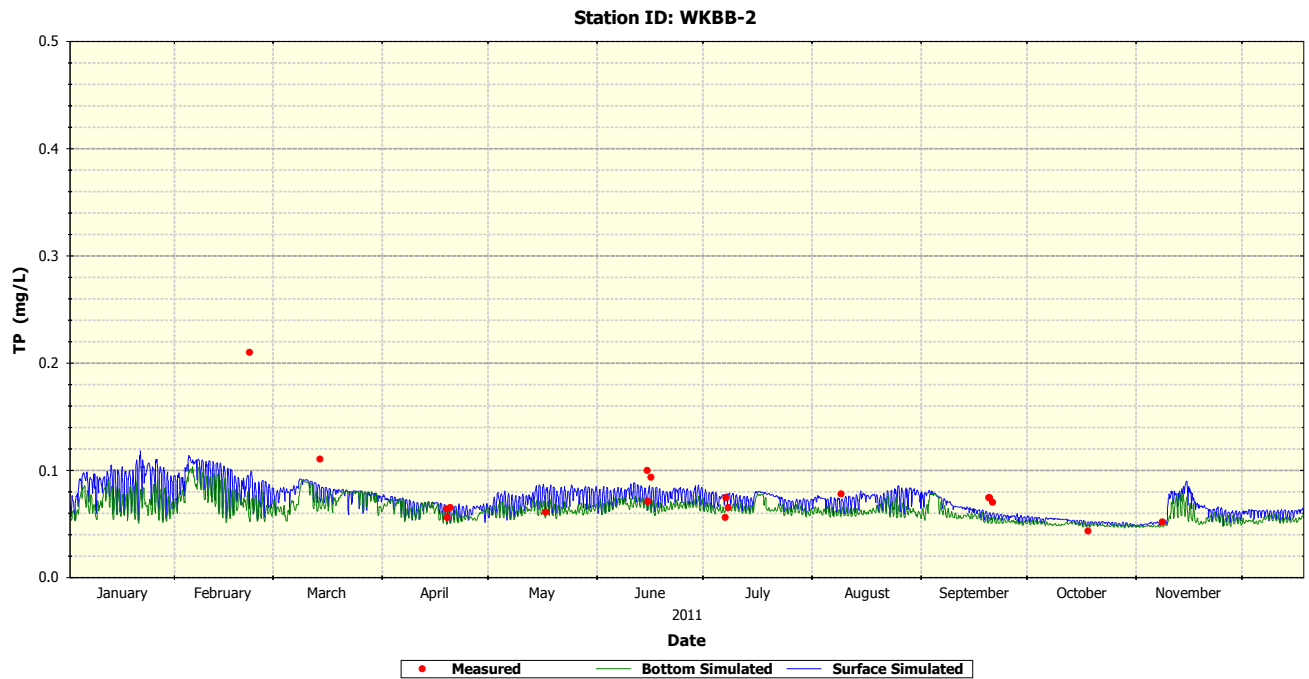

Figure B-3.5 TP dynamics at ADEM WB1 station



**Figure B-3.6** TP dynamics at ADEM WKBB1 station



**Figure B-3.7** TP dynamics at ADEM WKBB2 station

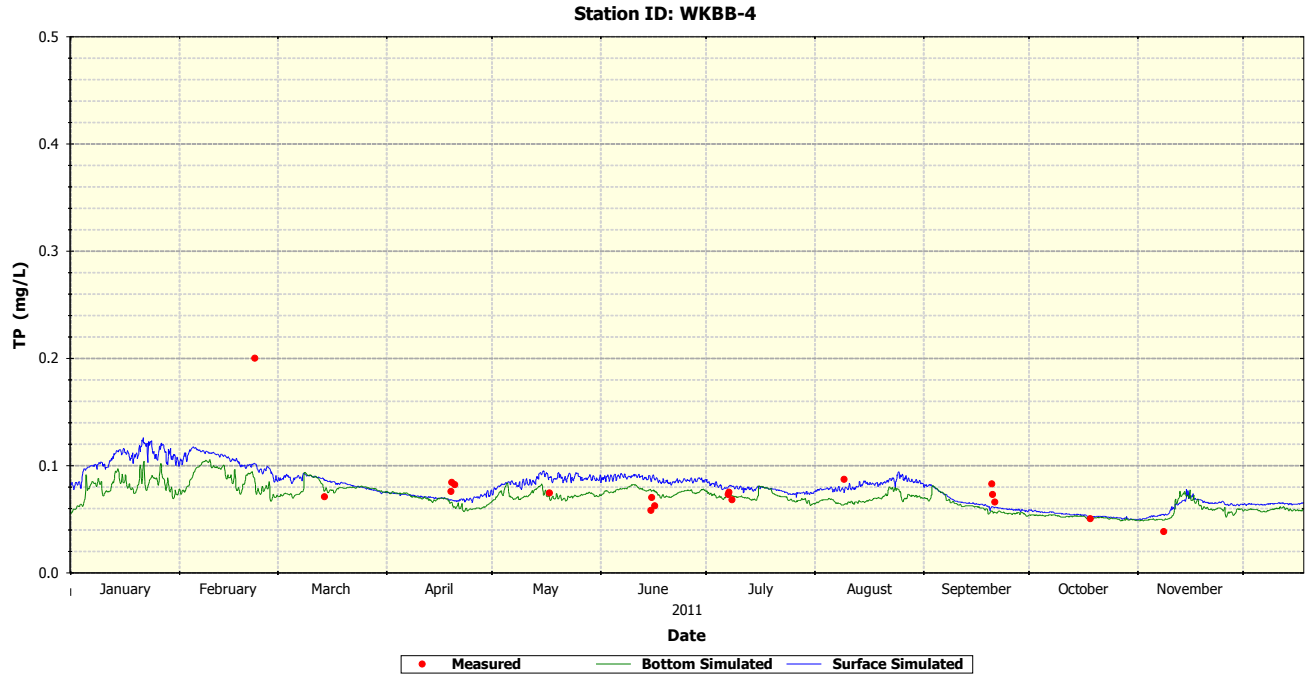

**Figure B-3.8** TP dynamics at ADEM WKBB4 station

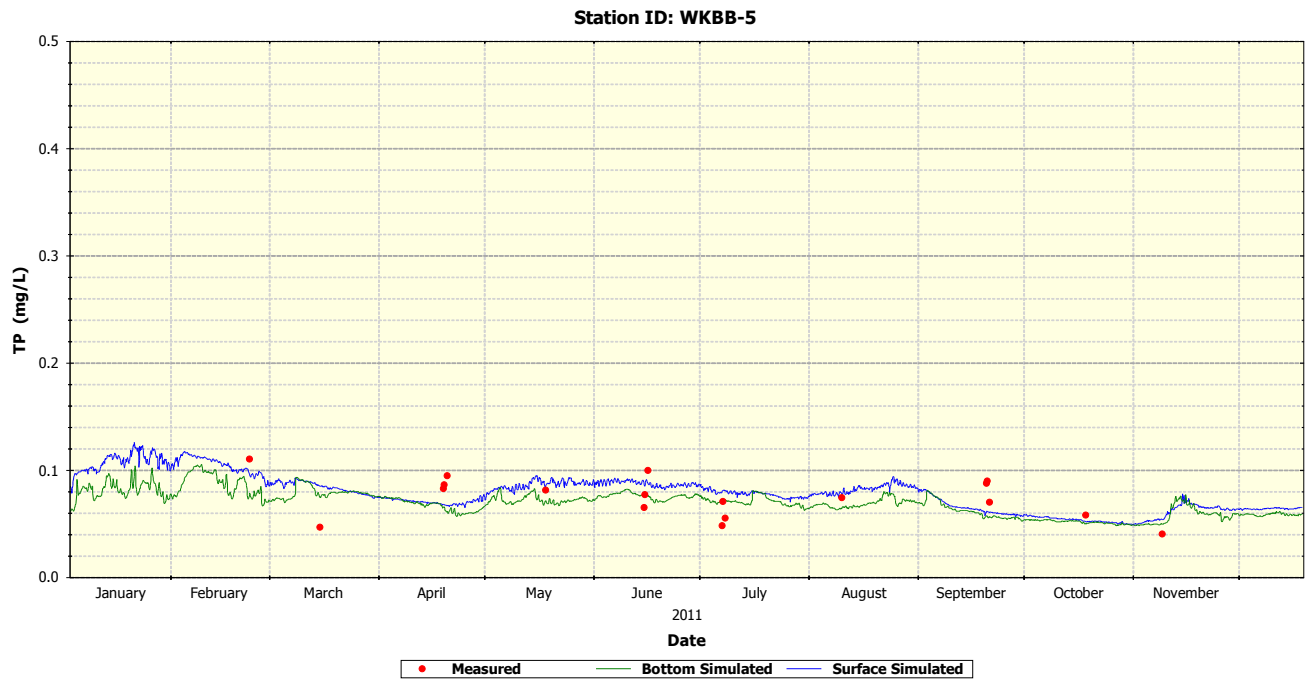

**Figure B-3.9** TP dynamics at ADEM WKBB5 station

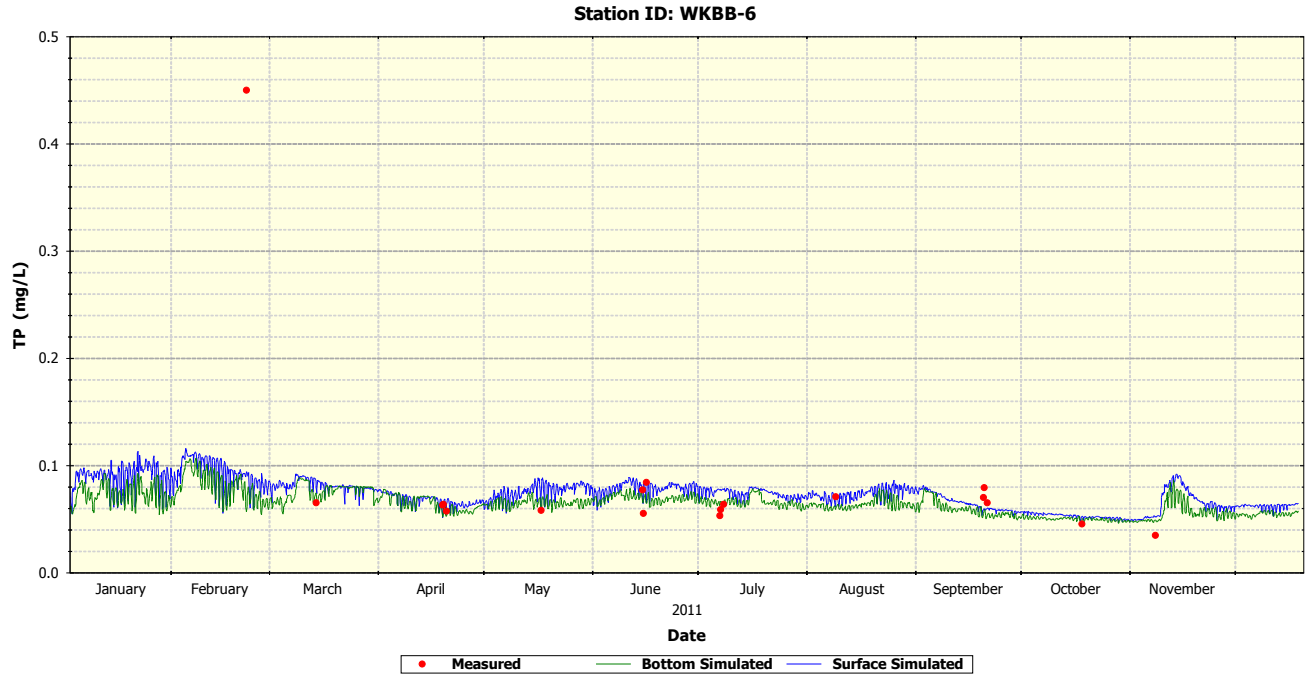

**Figure B-3.10** TP dynamics at ADEM WKBB6 station



## B-4 Dissolved Oxygen Dynamics

Tables B-4.1 and B-4.2 as well as Figures B-4.1 through B-4.10 represent the numerical and visual comparisons of dissolved oxygen simulations in surface in bottom layers of the Weeks Bay WASP model with the available NERRS and ADEM monitoring data that were collected during years 2008-2011.

Observed oversaturated DO concentrations throughout the year and particularly during winter months can be explained by the technical characteristics of YSI meters that were used in DO monitoring. This observed effect is explained in a Technical Note of the YSI manufacturer (YSI, 2005): “From our extensive experience in the field and testing our instruments at the YSI facility, values over 100% saturation have proven to be quite common. The one possible cause of dissolved oxygen reading over 100% saturation can be non-ideal air/water equilibration that is typical for water bodies except for fast-moving streams.”

The daily averaging of instant DO measurements improves simulation and measurement correspondence. The numerical metrics of correspondence of salinity simulations vs. measurements are presented in Tables B-4.1 and B-4.2.

**Table B-4.1 Comparisons of simulations and measurements of Dissolved oxygen at NERRS monitoring stations: years 2008-2011**

Station	Simulations (mg/l)		Measurements (mg/l)	Deviation (%)	
	Mean Surface	Mean Bottom	Mean	Surface	Bottom
Mid-Bay	8.2	4	7.3	12	-45
Weeks Bay	8	6.4	7.3	10	-12
Magnolia River	8.7	6.4	7.4	18	-14
Fish River	8.2	2	6.8	21	-71

**Table B-4.2 Comparisons of simulations and measurements of Dissolved oxygen at ADEM monitoring stations: year 2011**

Station	Simulations (mg/l)		Measurements (mg/l)	Deviation (%)	
	Mean Surface	Mean Bottom	Mean	Surface	Bottom
WB1	7.3	1	7.3	0	-86
WKBB1	7.2	3.4	7.8	-8	-56
WKBB2	7.7	7.6	7.2	7	6
WKBB4	7.6	3.2	8.5	-11	-62
WKBB5	7.1	2.3	8.5	-16	-73
WKBB6	7.7	7.1	8.1	-5	-12

The deviations of bottom and surface dissolved oxygen simulations are in a range of 6-86% and 0-18% correspondently.

The comparisons of the deviation values with the calibration quality rating table (Main Report) allow estimating the calibrated EFDC model performance at locations of the bay’s monitoring station with grades that are presented in Table B-4.3

**Table B-4.3 Quality of dissolved oxygen calibration and validation**

Station	Dissolved Oxygen
MB	Very Good
WB1	Very Good
MR	Very Good
FR	Good
WB1	Very Good
WKBB1	Very Good
WKBB2	Very Good
WKBB4	Very Good
WKBB5	Good
WKBB6	Very Good

The figures B-4.1 through B-4.10 accurately enough display the observed ranges and general trends of dissolved oxygen dynamics in different parts of the bay.

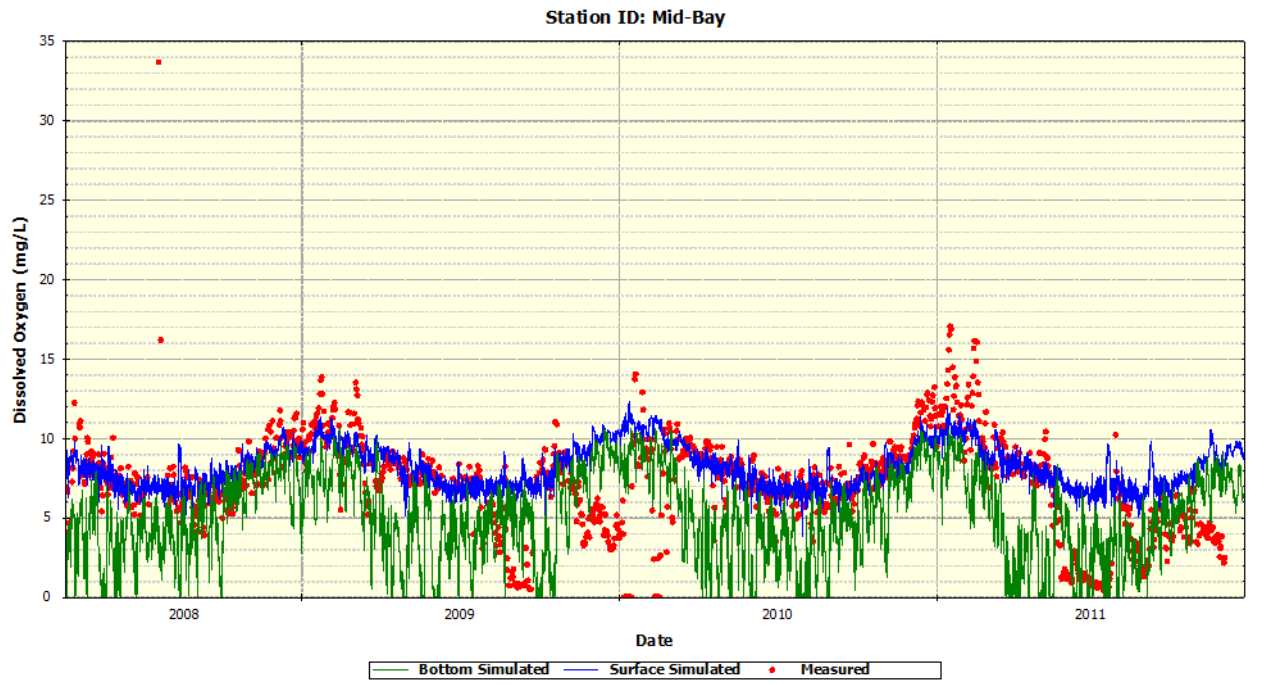

**Figure B-4.1 Dissolved oxygen dynamics at NERRS Middle Bay (MB) station**

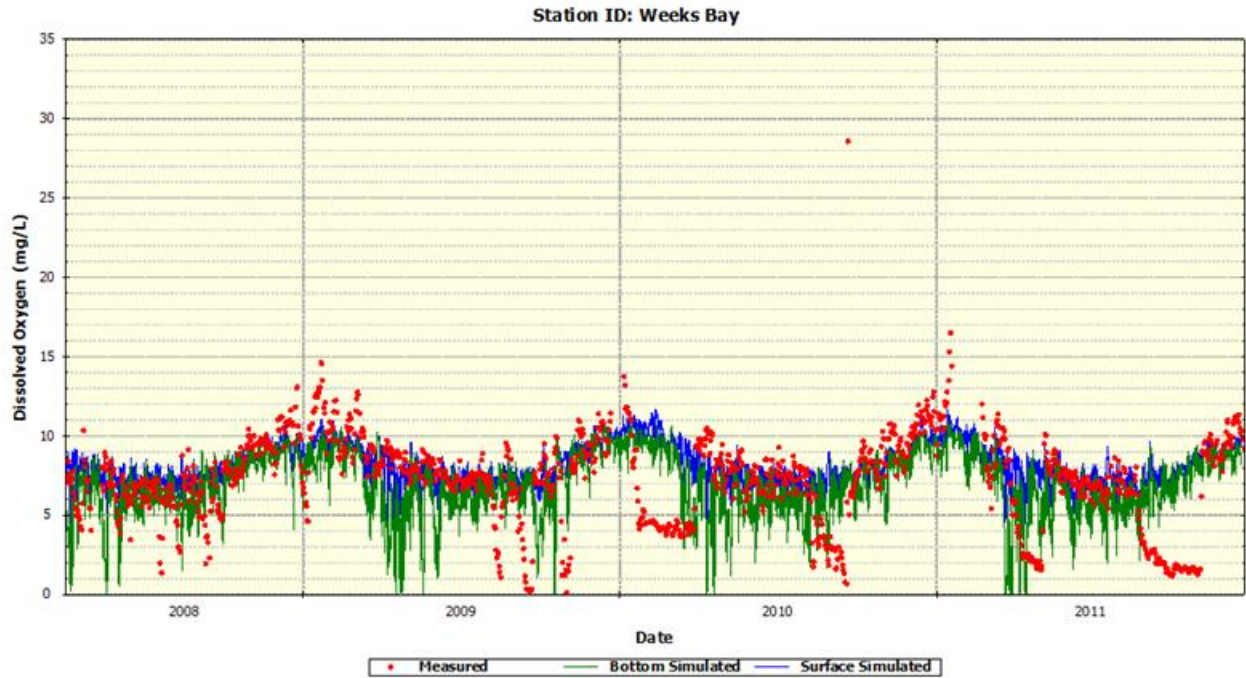

Figure B-4.2 Dissolved oxygen dynamics at NERRS Weeks Bay (WB) station

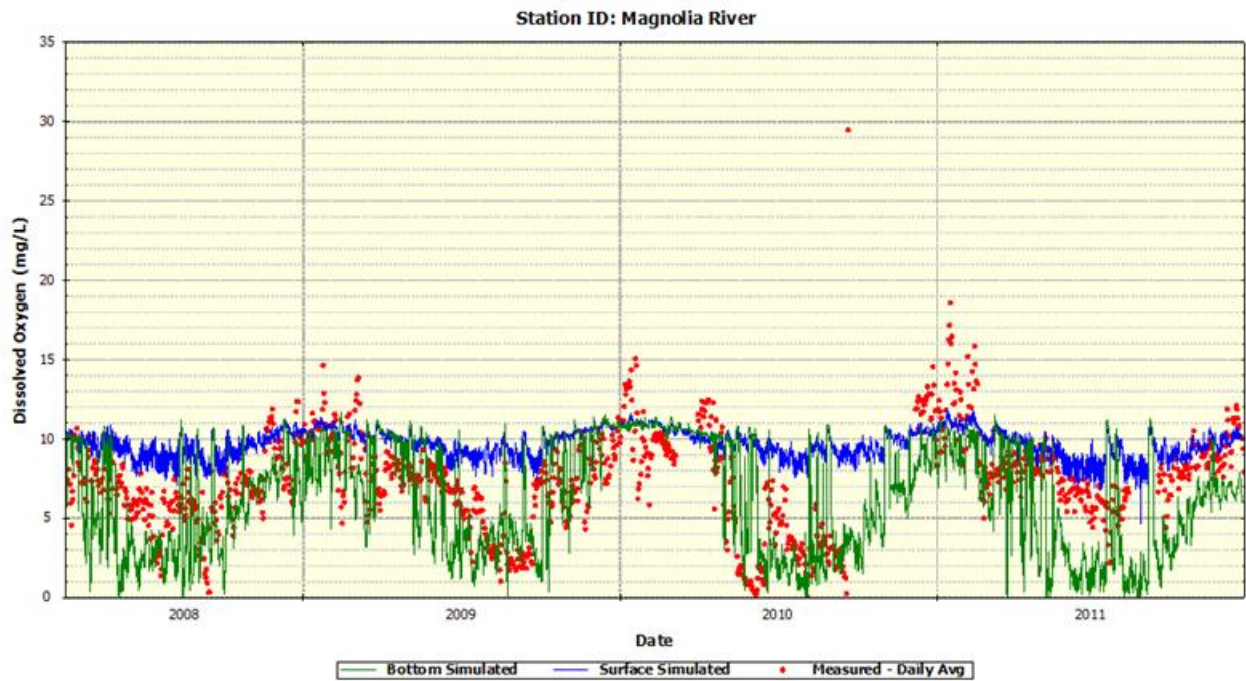

Figure B-4.3 Dissolved oxygen dynamics at NERRS Magnolia River (MR) station

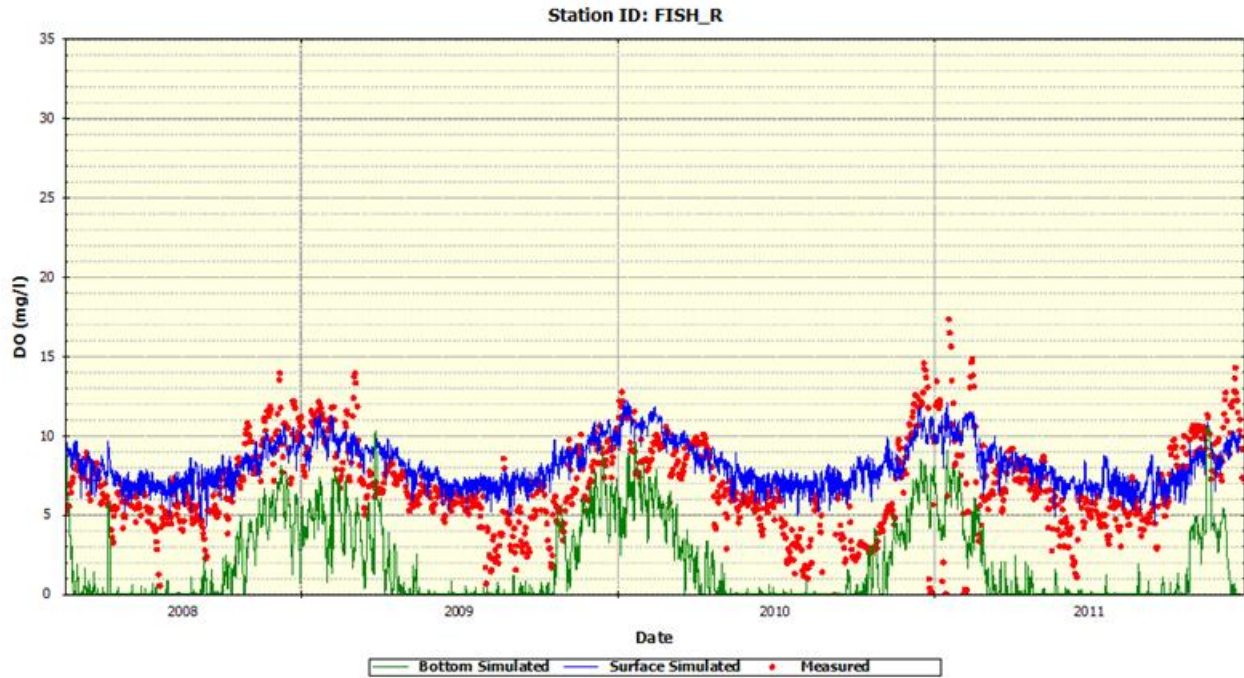

Figure B-4.4 Dissolved oxygen dynamics at NERRS Fish River (FR) station

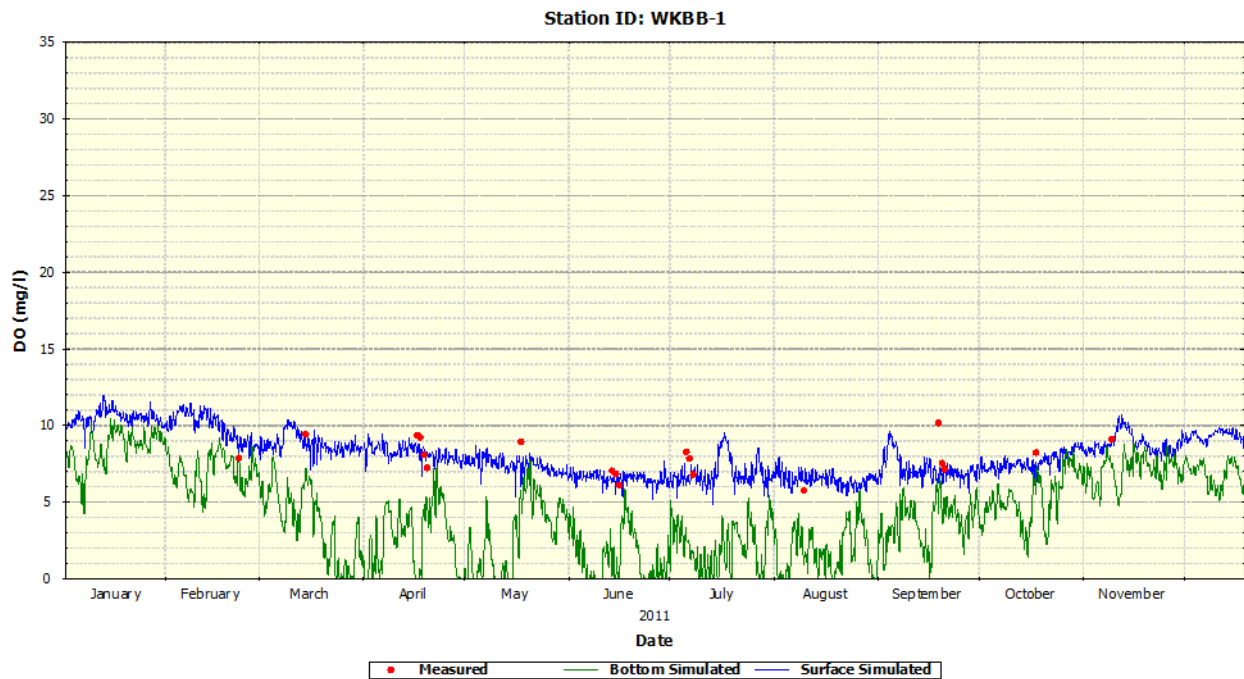

Figure B-4.5 Dissolved oxygen dynamics at ADEM WKBB1 station

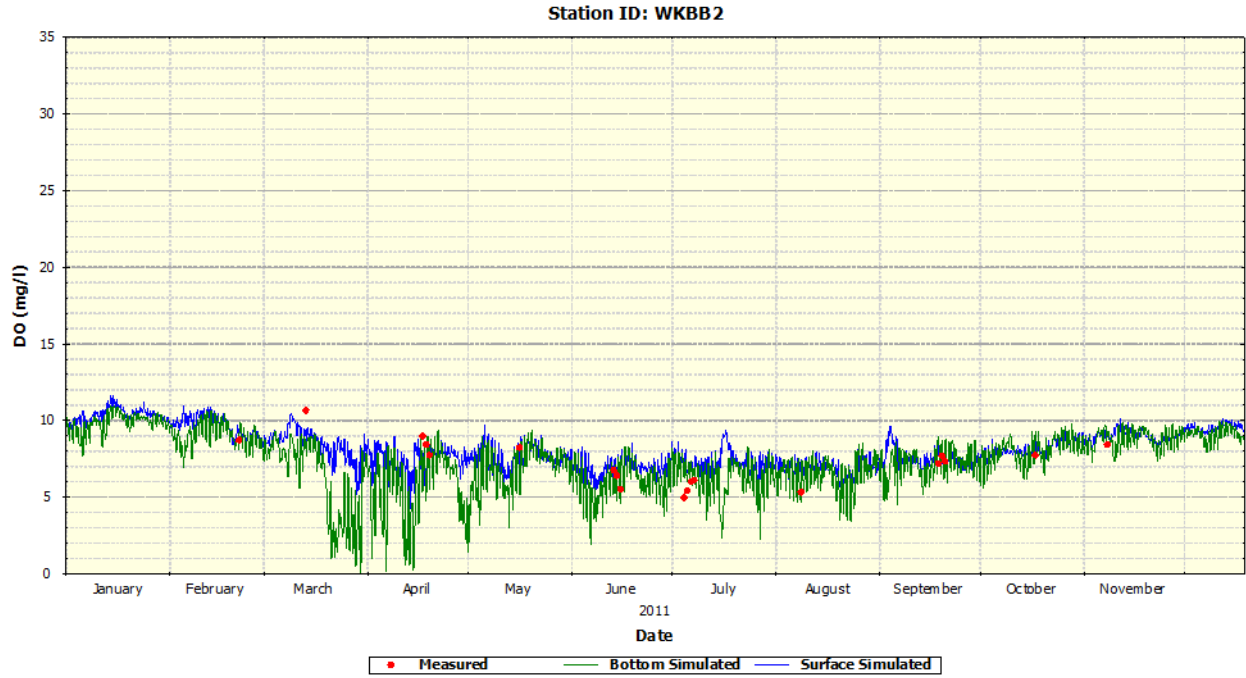

Figure B-4.6 Dissolved oxygen dynamics at ADEM WKBB2 station

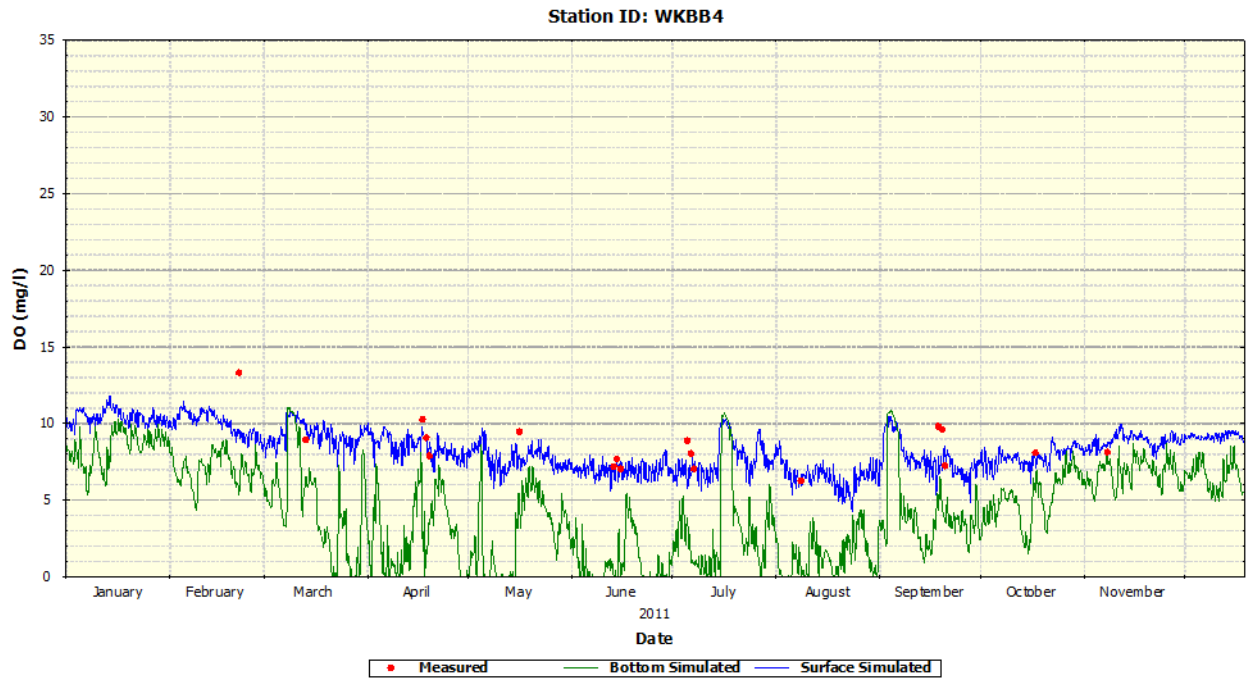

Figure B-4.7 Dissolved oxygen dynamics at ADEM WKBB4 station

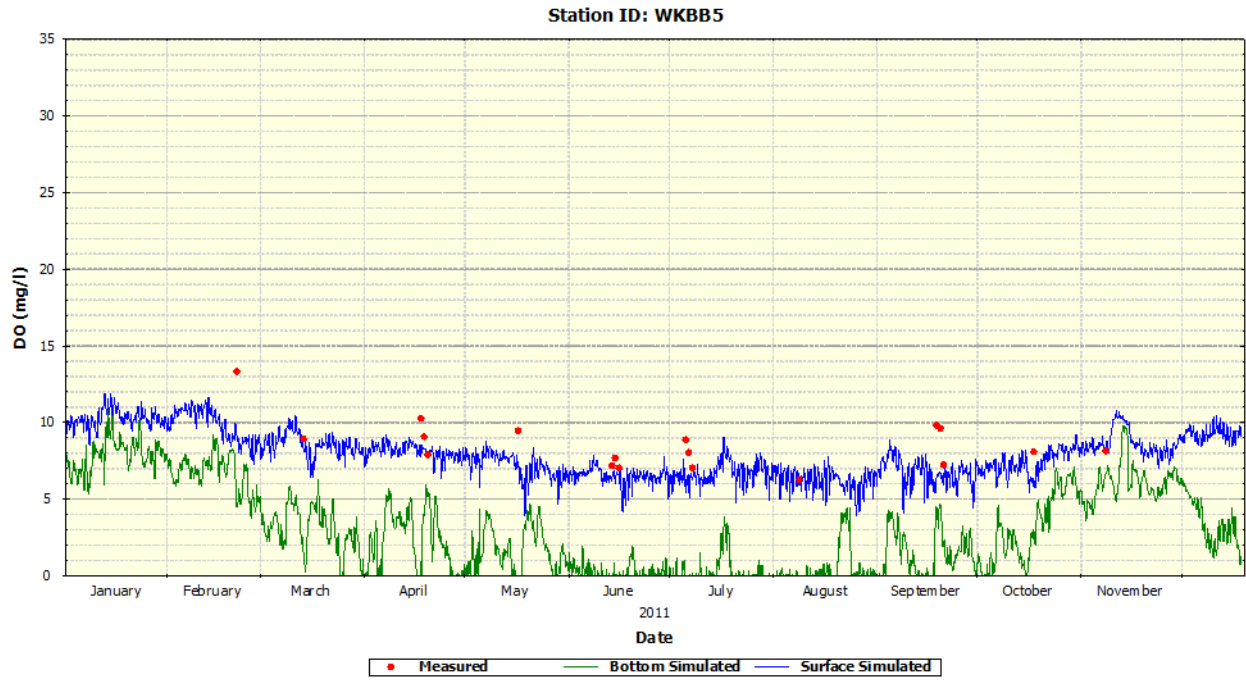

Figure B-4.8 Dissolved oxygen dynamics at ADEM WKBB5 station

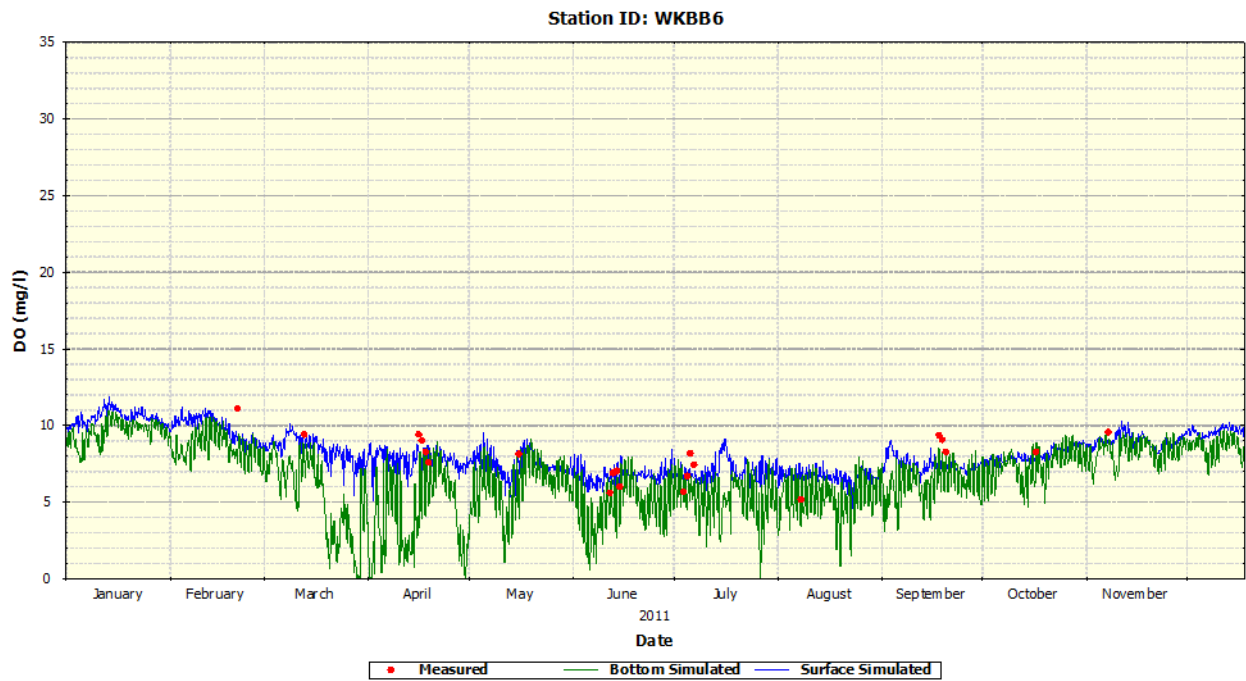
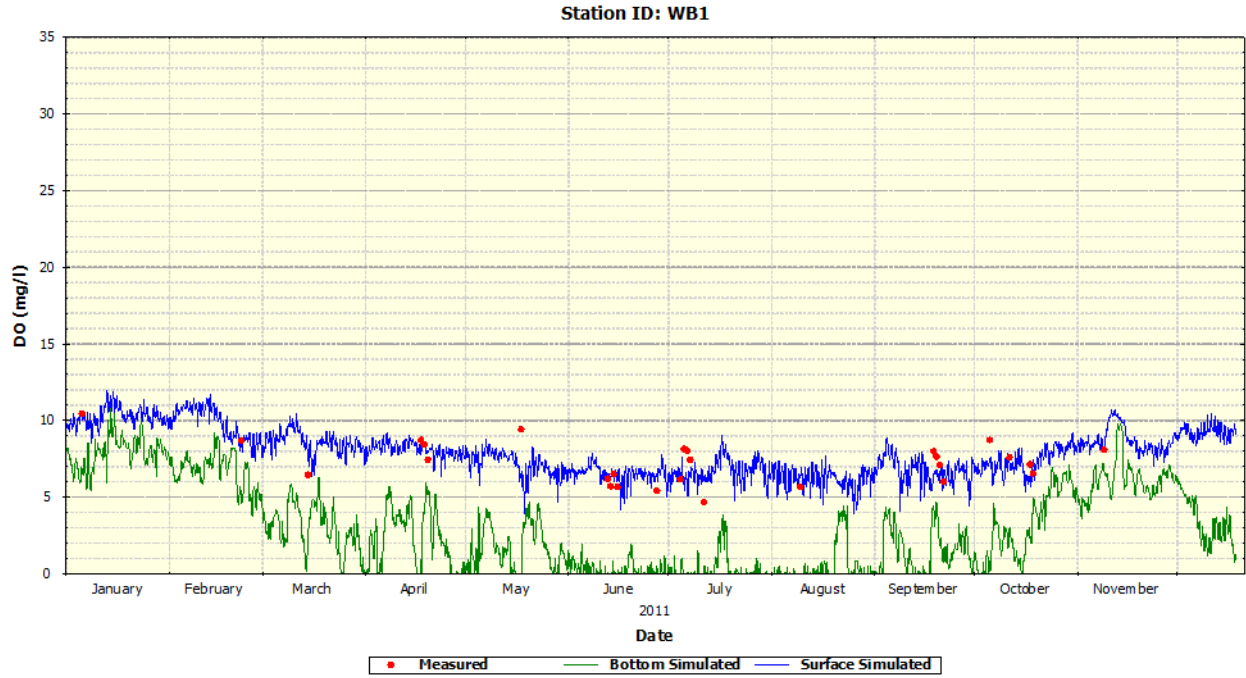

Figure B-4.9 Dissolved oxygen dynamics at ADEM WKBB6 station



**Figure B-4.10** Dissolved oxygen dynamics at ADEM WB1 station

## B-5 CBOD Dynamics

Table B-5.1 and Figures B-5.1 through B-5.6 represent the numerical and visual comparisons of CBOD simulations in surface in bottom layers of the Weeks Bay EFDC model with the available ADEM monitoring data that were collected during year 2011.

The numerical metrics of correspondence of salinity simulations vs. measurements are presented in Tables B-5.1.

**Table B-5.1 Comparisons of simulations and measurements of CBOD at ADEM monitoring stations, Weeks Bay AL: year 2011**

Station	Simulations (mg/l)		Measurements (mg/l)	Deviation (%)	
	Mean Surface	Mean Bottom	Mean	Surface	Bottom
WB1	10.5	10.7	12.9	-19	-17
WKBB1	13.3	10.3	12.6	6	-18
WKBB2	12.6	7.3	11.1	14	-34
WKBB4	17	10.4	14	21	-26
WKBB5	11.7	10.8	12.9	-9	-16
WKBB6	12.3	8.1	10.2	21	-21

The deviations of bottom and surface CBOD are in a range of 16-34% and 6-21% correspondently. The comparisons of the deviation values with the calibration quality rating table (Main Report) allow estimating the calibrated EFDC model performance at locations of the bay's monitoring station with grades that are presented in Table B-5.2

**Table B-5.2 Quality of CBOD calibration and validation**

Station	CBOD
WB1	Good
WKBB1	Very Good
WKBB2	Very Good
WKBB4	Good
WKBB5	Very Good
WKBB6	Good

The figures B-5.1 through B-5.6 accurately display the ranges and general trends of CBOD dynamics in different parts of the bay.



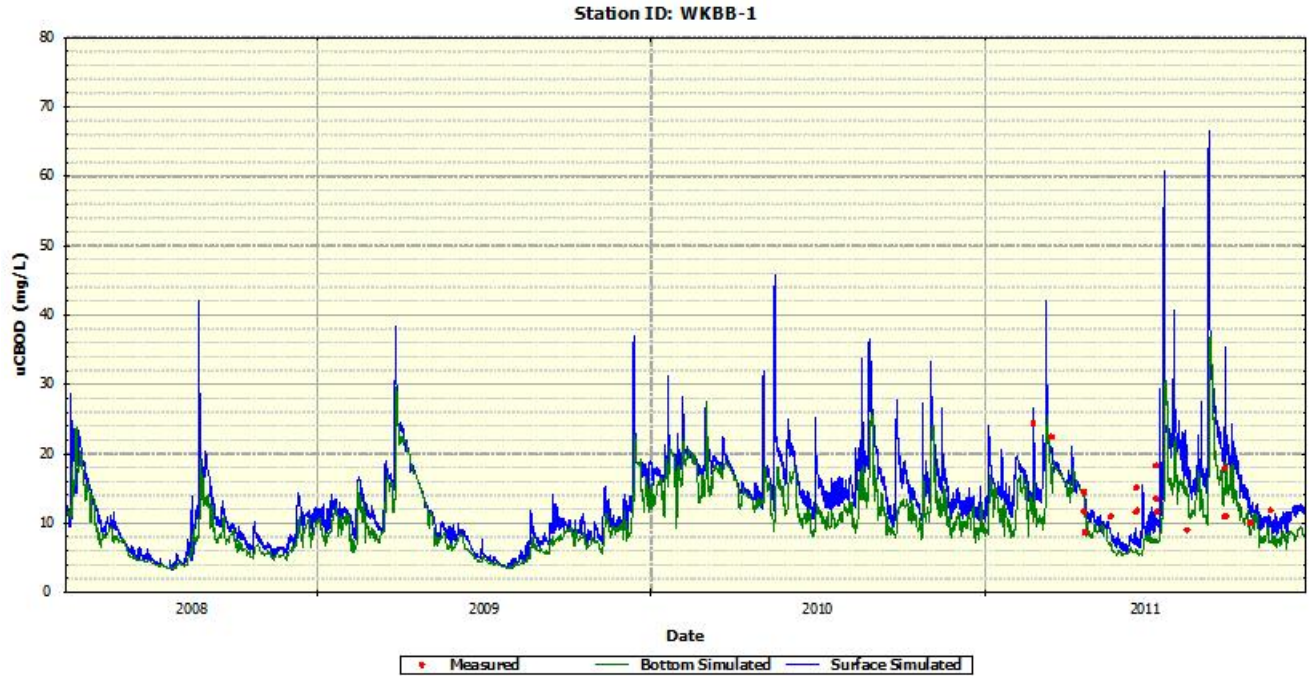

Figure B-5.1 CBOD dynamics at ADEM WKBB1 station

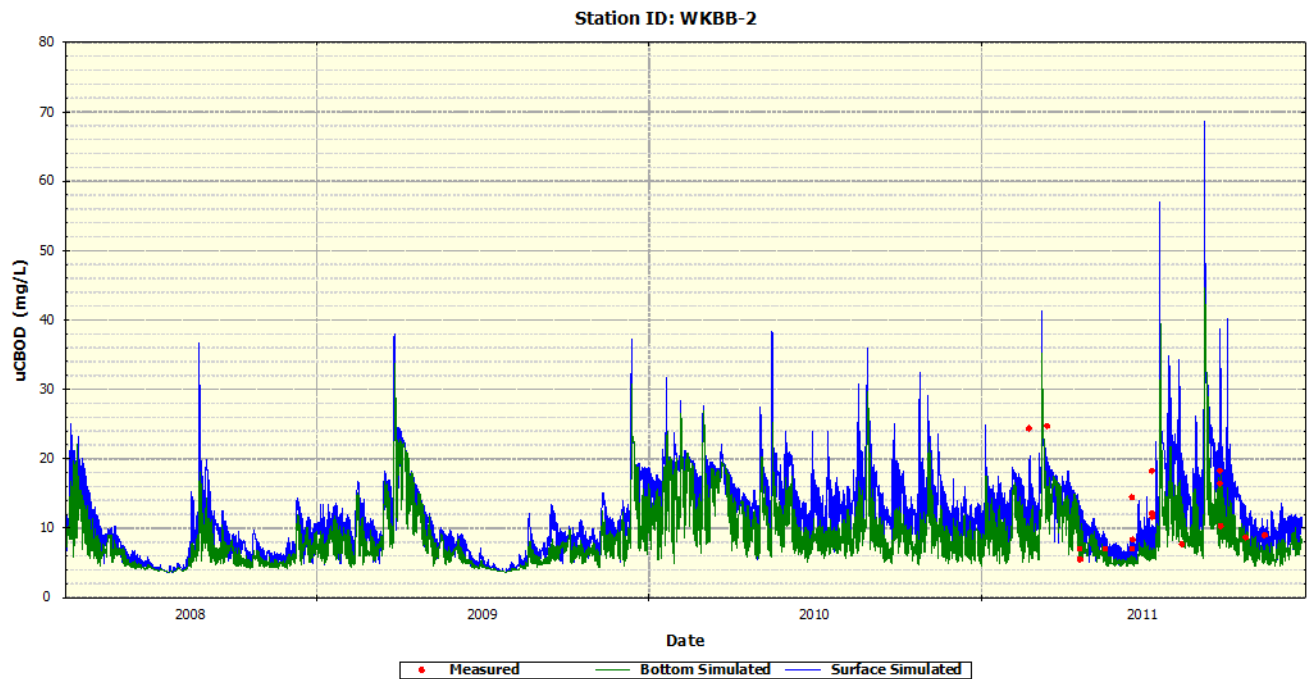

Figure B-5.2 CBOD dynamics at ADEM WKBB2 station

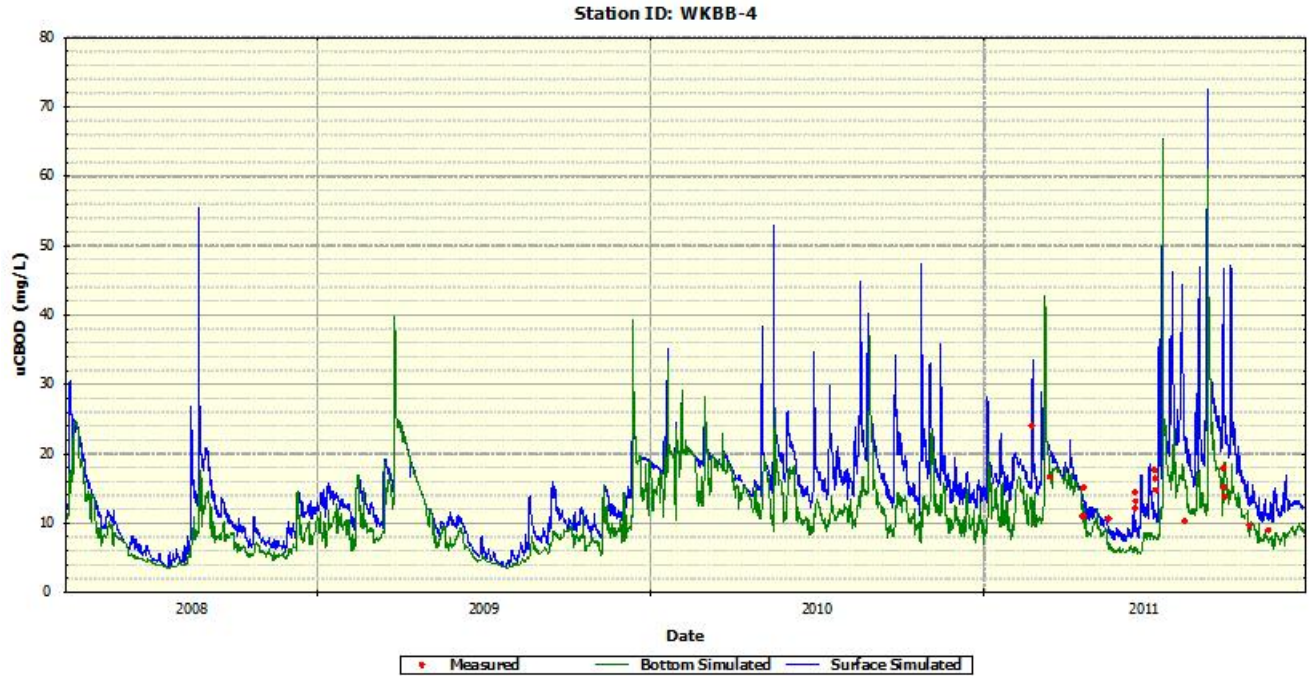

Figure B-5.3 CBOD dynamics at ADEM WKBB4 station

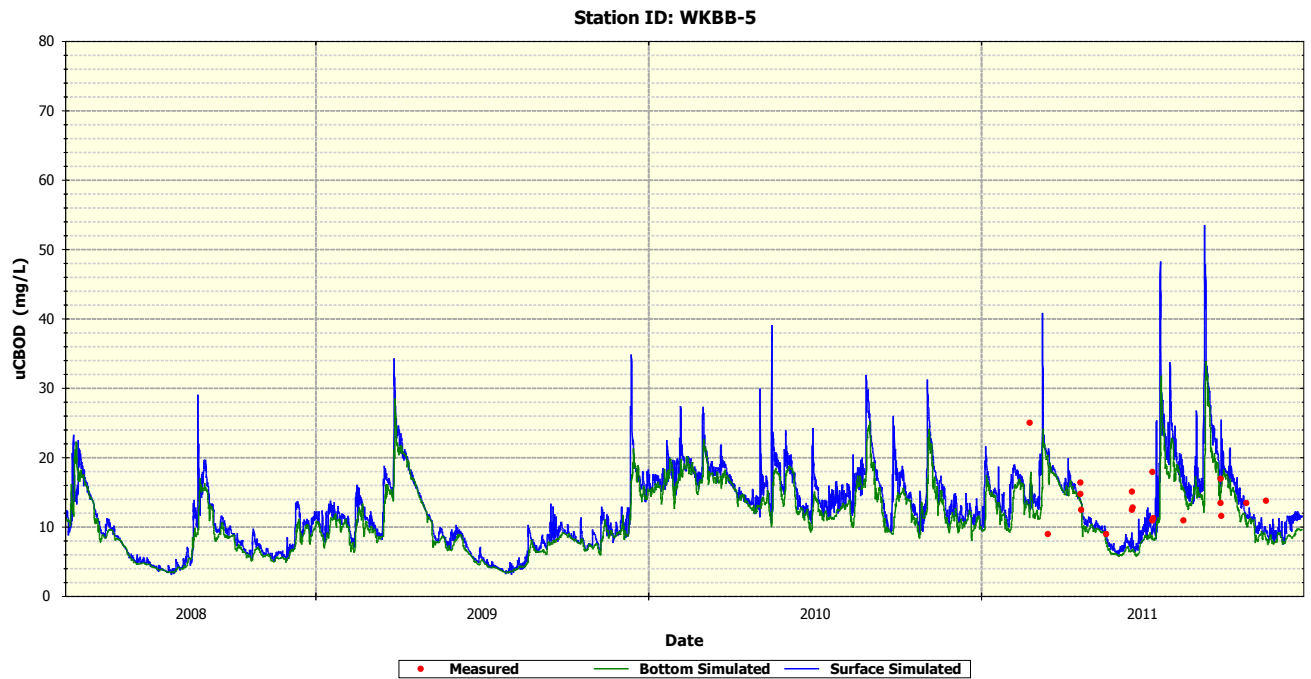

Figure B-5.4 CBOD dynamics at ADEM WKBB5 station

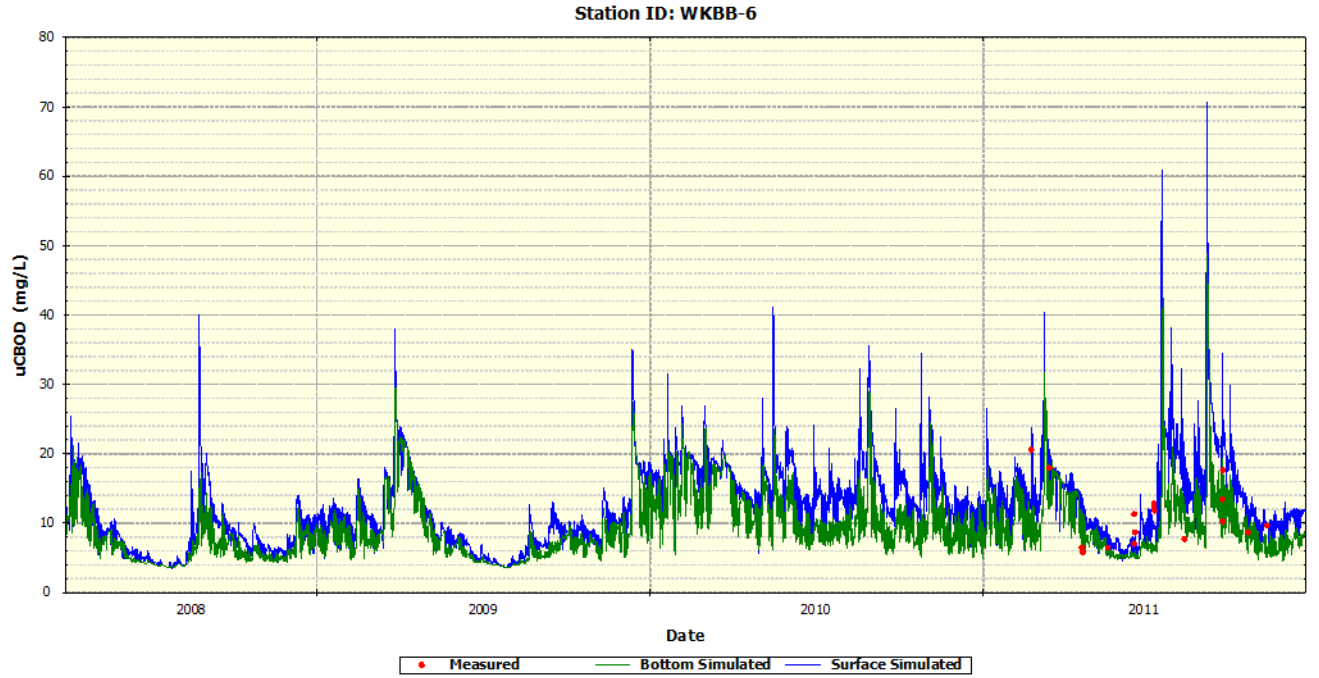

Figure B-5.5 CBOD dynamics at ADEM WKBB6 station

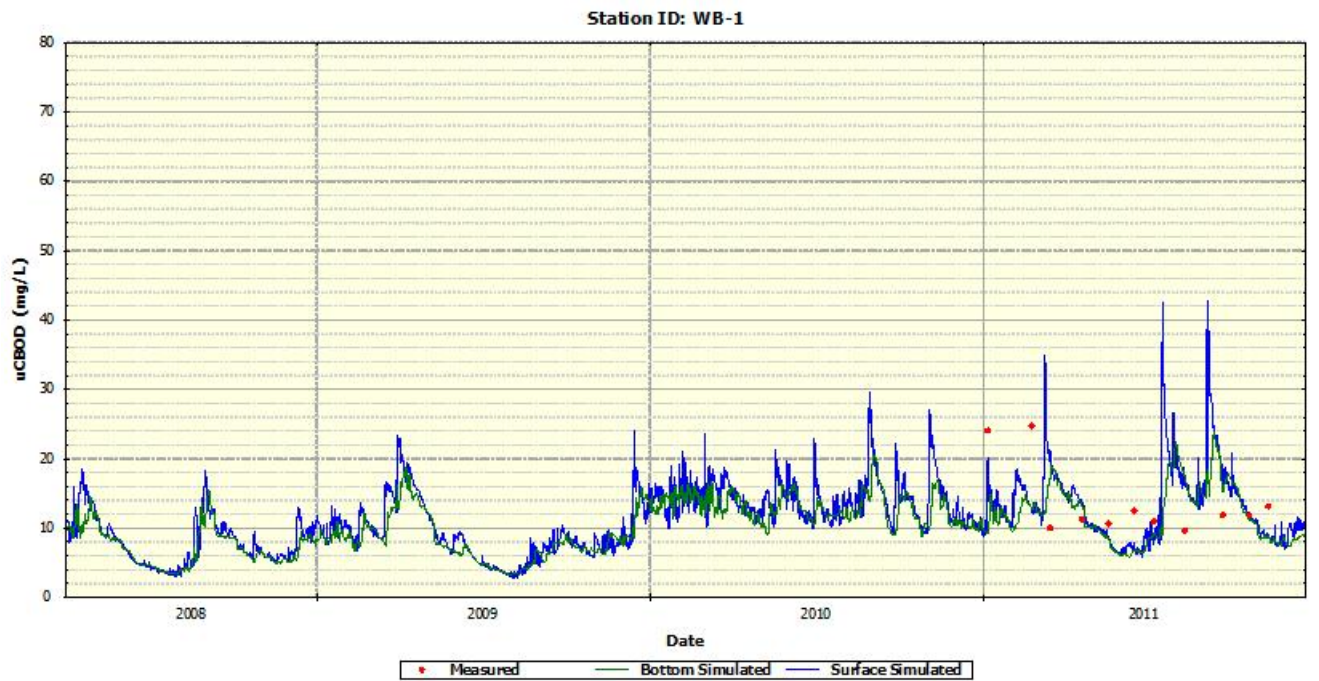

Figure B-5.6 CBOD dynamics at ADEM WB1 station

## B-6 TSS Dynamics

Table B-6.1 and Figures B-6.1 through B-6.6 represent the numerical and visual comparisons of TSS simulations in surface in bottom layers of the Weeks Bay EFDC model with the available ADEM monitoring data that were collected during year 2011.

The numerical metrics of correspondence of salinity simulations vs. measurements are presented in Tables B-6.1.

**Table B-6.1 Comparisons of simulations and measurements of TSS at ADEM monitoring stations, Weeks Bay AL: year 2011**

Station	Simulations (mg/l)		Measurements (mg/l)	Deviation (%)	
	Mean Surface	Mean Bottom	Mean	Surface	Bottom
WB1	21.1	26.6	20.4	3	30
WKBB1	27.6	23.7	28.2	-2	-16
WKBB2	28.2	31.2	28.9	-2	8
WKBB4	19.9	25.7	24	-17	7
WKBB5	23.1	22.1	22.7	2	-3
WKBB6	27	29.8	27.3	-1	9

The deviations of bottom and surface CBOD are in a range of 16-34% and 6-21% correspondently. The comparisons of the deviation values with the calibration quality rating table (Main Report) allow estimating the calibrated EFDC model performance at locations of the bay's monitoring station with grades that are presented in Table B-6.2

**Table B-6.2 Quality of CBOD calibration and validation**

Station	CBOD
WB1	Very Good
WKBB1	Very Good
WKBB2	Very Good
WKBB4	Very Good
WKBB5	Very Good
WKBB6	Very Good

The figures B-6.1 through B-6.6 accurately display the ranges and general trends of CBOD dynamics in different parts of the bay.

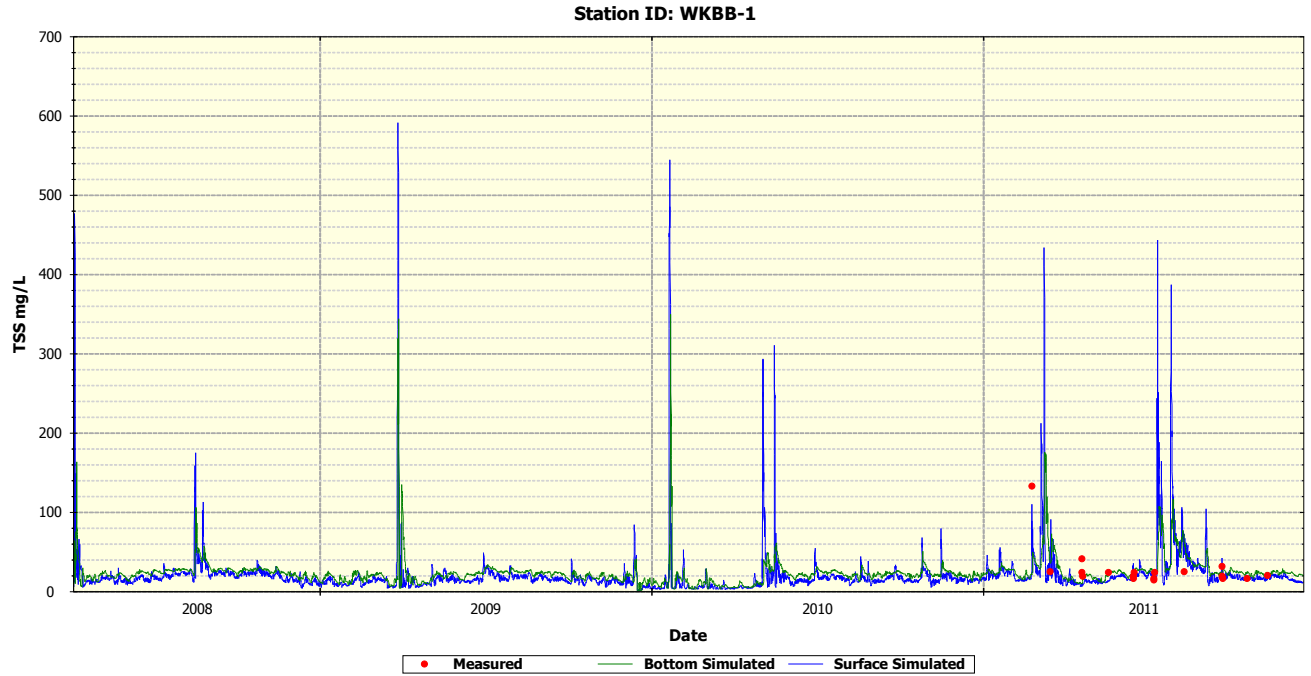

Figure B-6.1 TSS dynamics at ADEM WKBB1 station

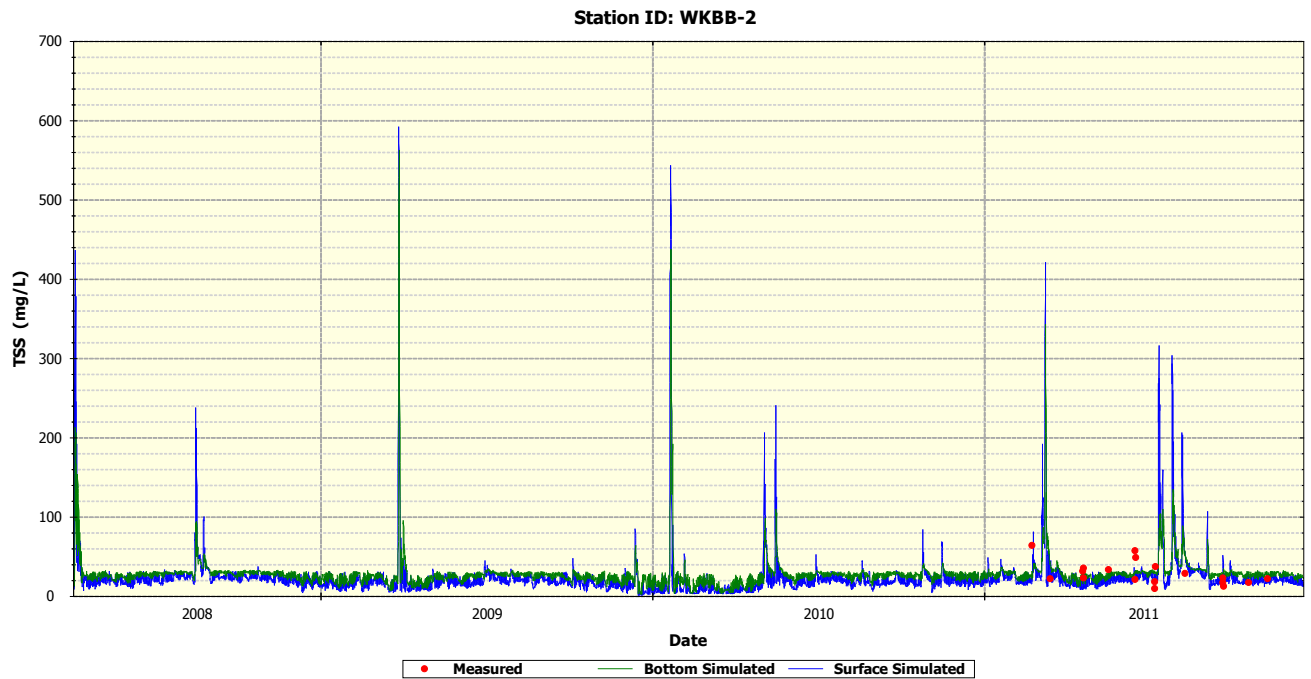

Figure B-6.2 TSS dynamics at ADEM WKBB2 station

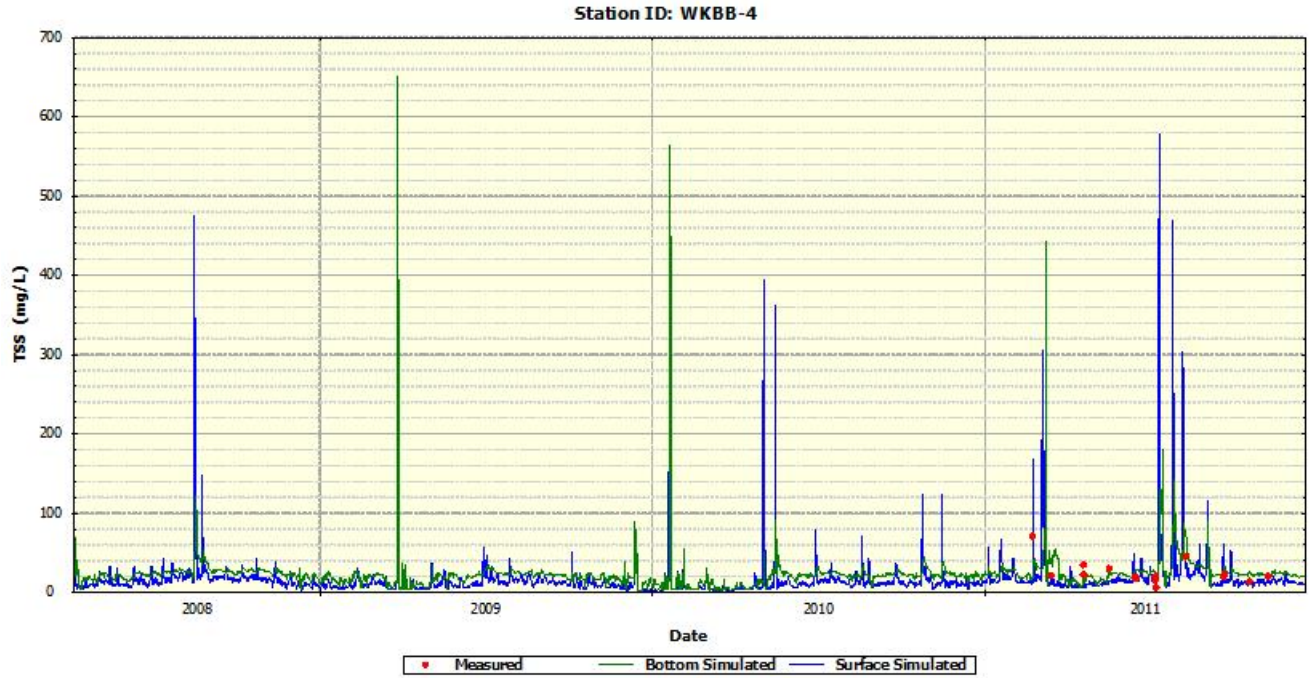

Figure B-6.3 TSS dynamics at ADEM WKBB4 station

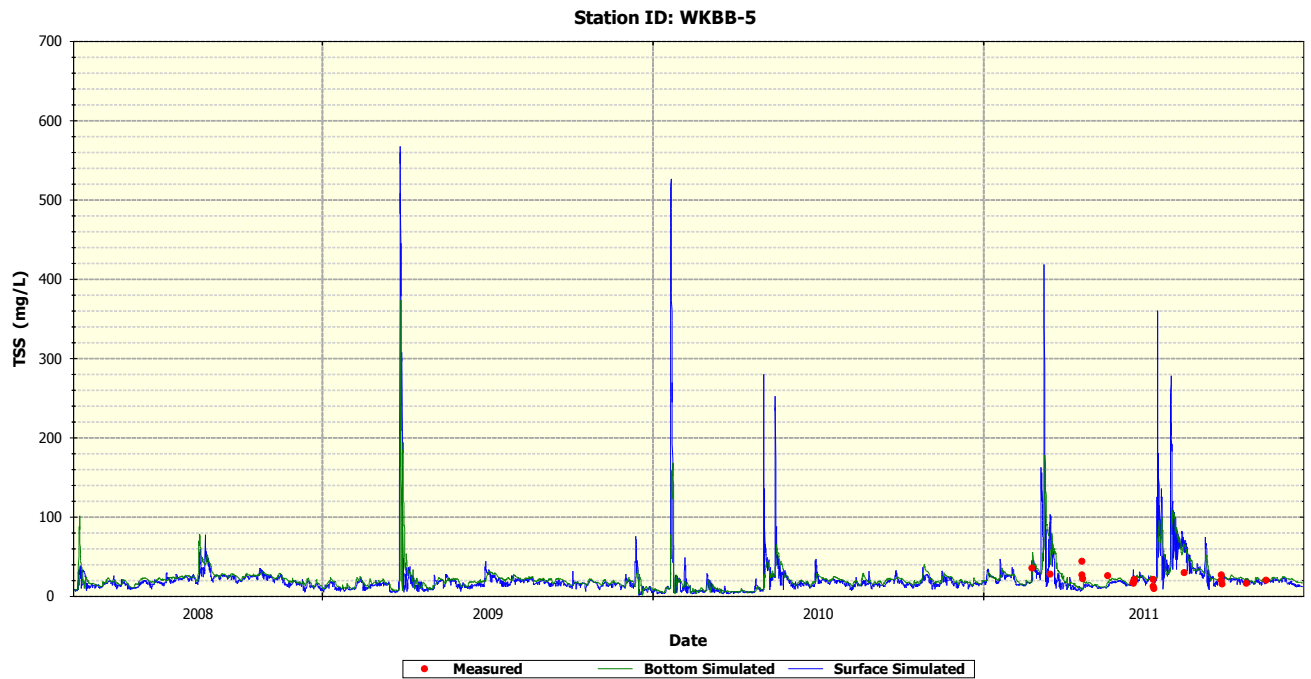

Figure B-6.4 TSS dynamics at ADEM WKBB5 station

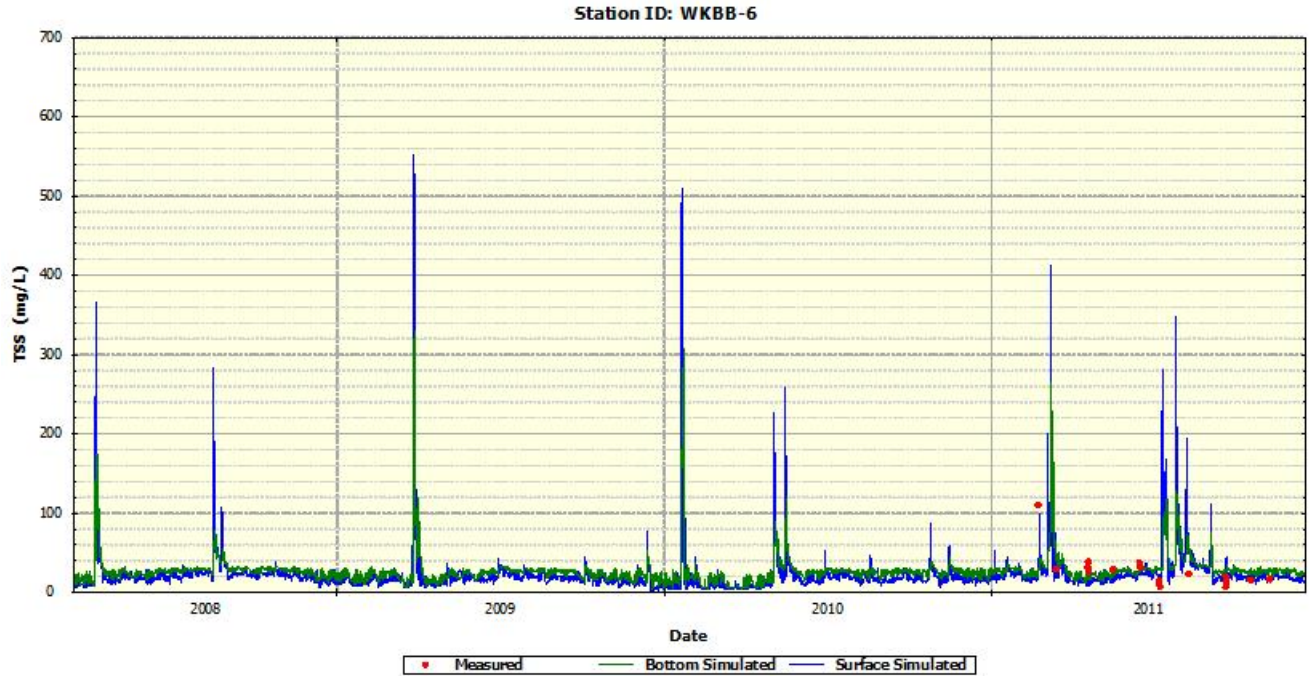

Figure B-6.5 TSS dynamics at ADEM WKBB6 station

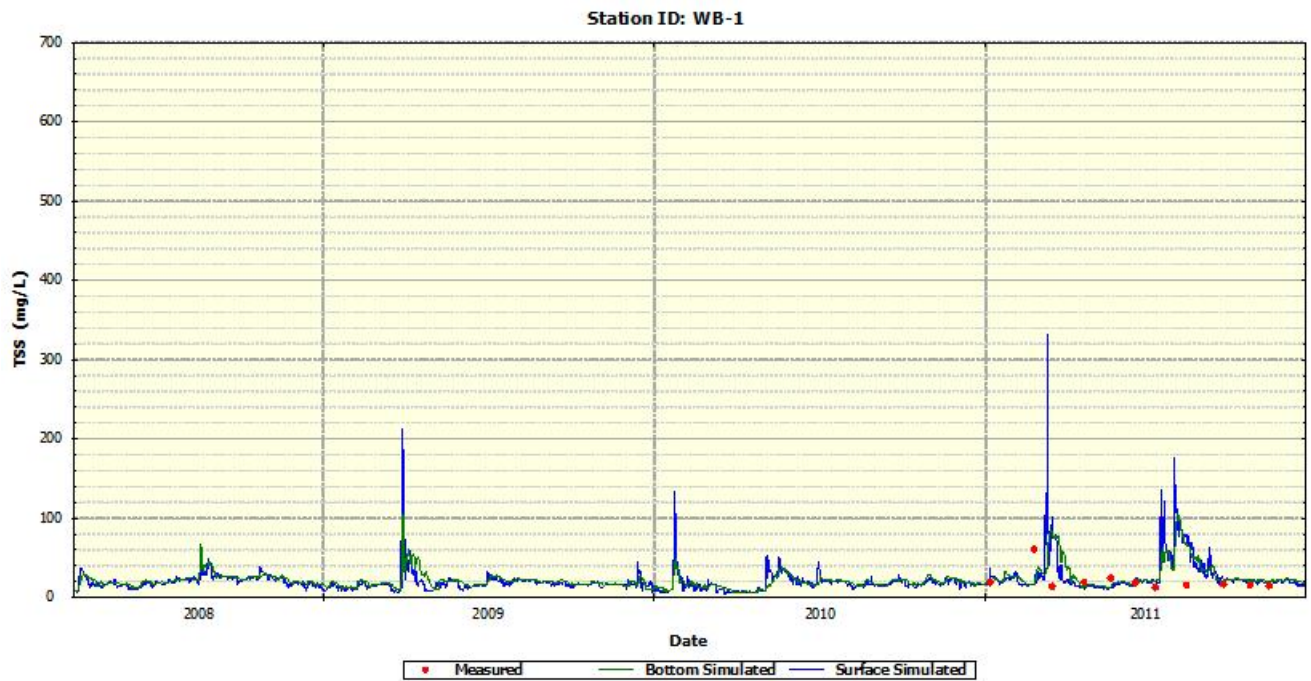

Figure B-6.6 TSS dynamics at ADEM WB1 station





*Appendix C*

**Modeling of Water Quality of Weeks Bay:  
Spatial Distribution of Water Quality  
Constituents**

**Simulation Period: Years 2009-2011**

## Figures

Figure C-1	50 <sup>th</sup> percentile of surface Chlorophyll <i>a</i> (µg/l) .....	C-3
Figure C-2	50 <sup>th</sup> percentile of surface TN (mg/l).....	C-4
Figure C-3	50 <sup>th</sup> percentile of surface TP (mg/l) .....	C-4
Figure C-4	50 <sup>th</sup> percentile of surface CBOD (mg/l).....	C-5
Figure C-5	50 <sup>th</sup> percentile of surface TSS (mg/l).....	C-5
Figure C-6	50 <sup>th</sup> percentile of bottom salinity (ppt).....	C-6
Figure C-7	50 <sup>th</sup> percentile of bottom dissolved oxygen (mg/l) .....	C-6
Figure C-8	50 <sup>th</sup> percentile of surface dissolved oxygen (mg/l).....	C-7
Figure C-9	50 <sup>th</sup> percentile of light extinction coefficient (1/m) .....	C-7

Figures C.1 through C.9 display the spatial distribution of 50<sup>th</sup> percentile of major simulated water quality constituents in Weeks Bay.

Figure C-1 shows that the surface Chlorophyll *a* concentrations in Fish and Magnolia Rivers are low in comparison to the mid-bay area. Total Nitrogen (Figure C-2) concentrations are highest in Fish and Magnolia Rivers. TN concentrations are diluted by low nitrogen marine waters. TP concentrations (Figure C-3) behave similarly. The difference in TP concentrations for Fish and Magnolia Rivers are about 0.01 mg/L. CBOD concentrations (Figure C-4) are highest in Magnolia River. TSS concentrations (Figure C-5) are lowest in streams and increase due to mixing between freshwater and marine waters. TSS is highest in Mobile Bay itself. Salinity (Figure C-6) behaves similarly to TSS. It is lowest in streams and highest on Weeks Bay open boundaries. Surface DO (Figure C-7) shows the distribution which is close to uniform. The reason is the strong atmospheric source of oxygen (reaeration effect). Bottom DO (Figure C-8) shows the significant spatial differences that are caused by the depth and SOD horizontal distributions. The lowest concentrations of the bottom DO are in the deepest part of the modeled area (mouth of Fish River). The simulated distribution of light extinction coefficient (Figure C-9) can be used for identification of the bay's areas with favorable for benthic organisms light distribution. The highest light extinction coefficient was simulated in central parts of Mobile Bay. It indicates unfavorable conditions for submerged aquatic vegetation.

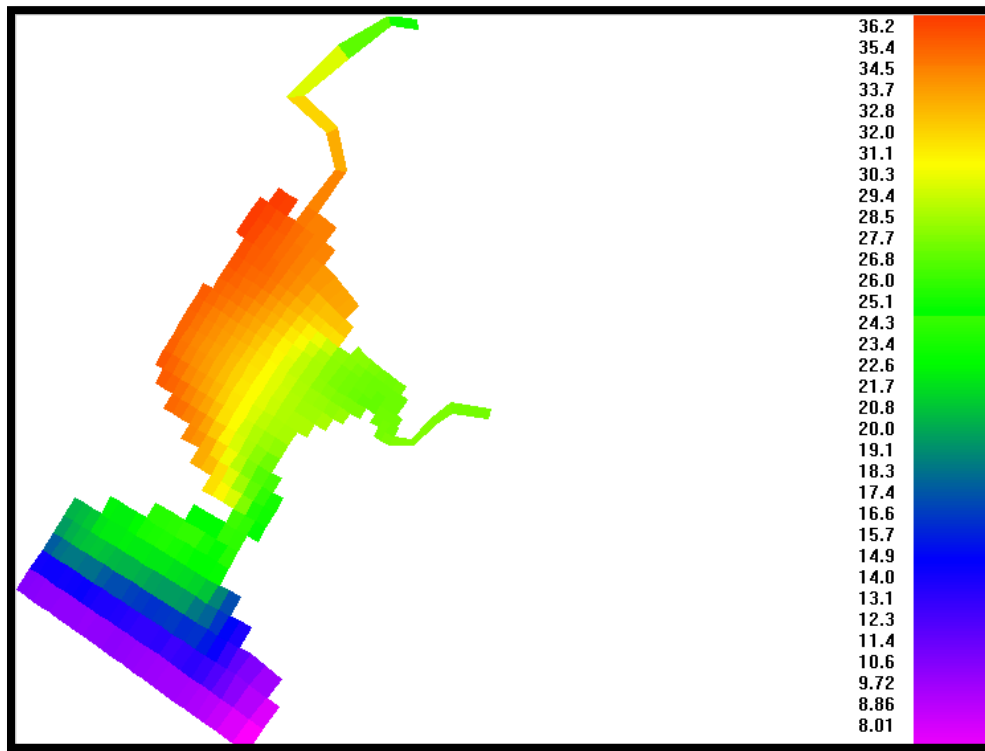

Figure C-1 50<sup>th</sup> percentile of surface Chlorophyll *a* (µg/l)

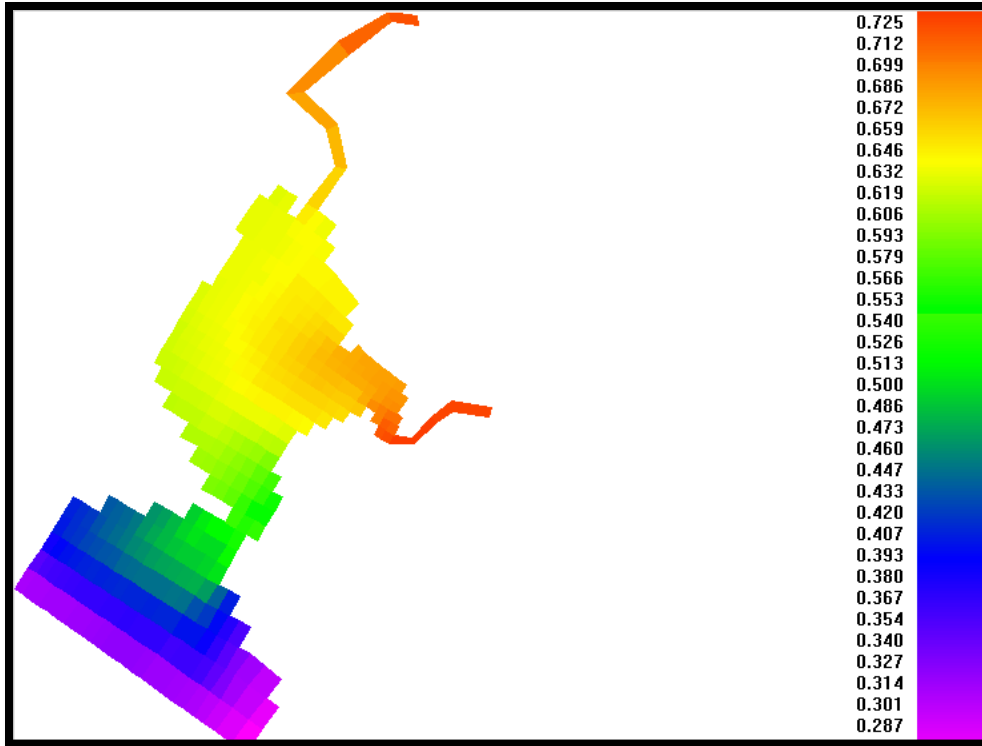

Figure C-2 50<sup>th</sup> percentile of surface TN (mg/l)

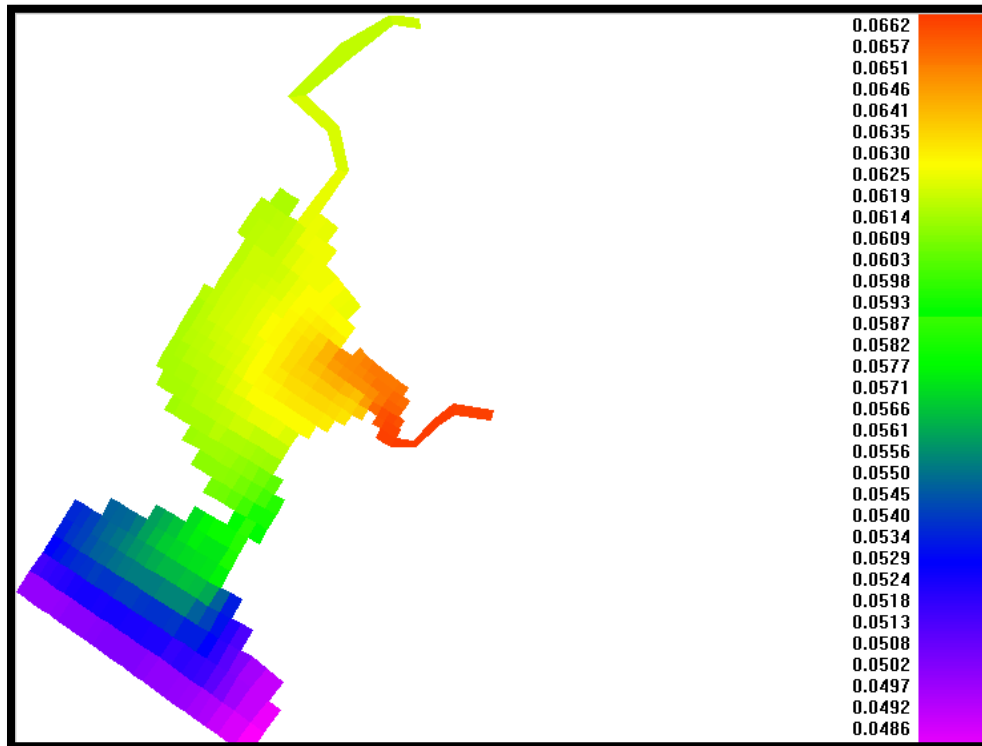

Figure C-3 50<sup>th</sup> percentile of surface TP (mg/l)

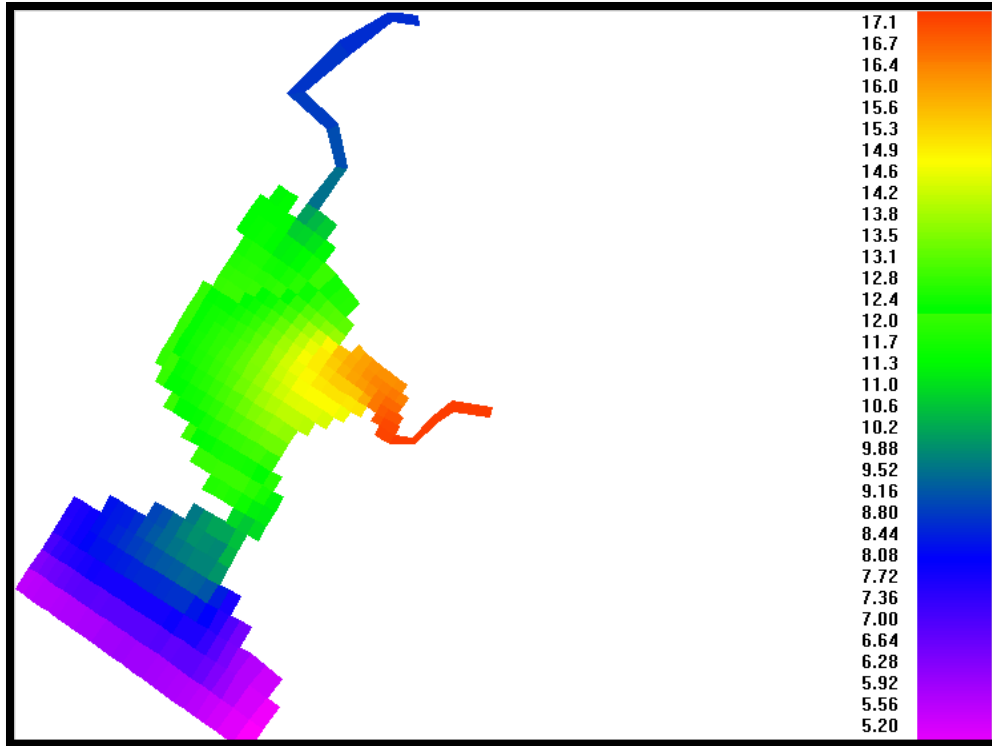

Figure C-4 50<sup>th</sup> percentile of surface CBOD (mg/l)

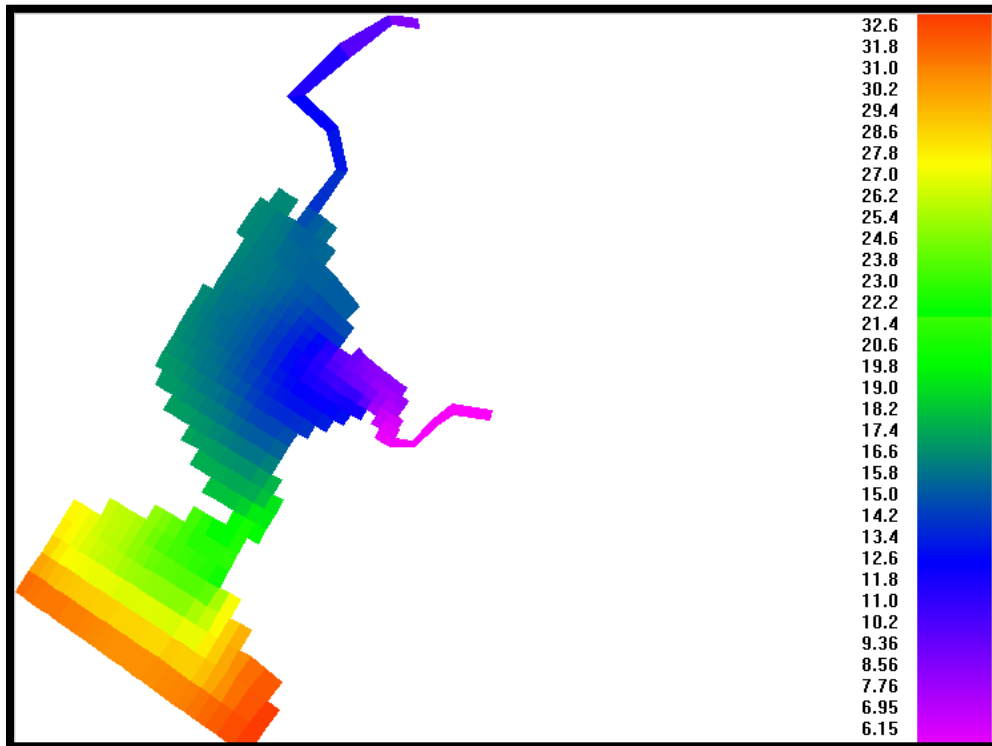

Figure C-5 50<sup>th</sup> percentile of surface TSS (mg/l)

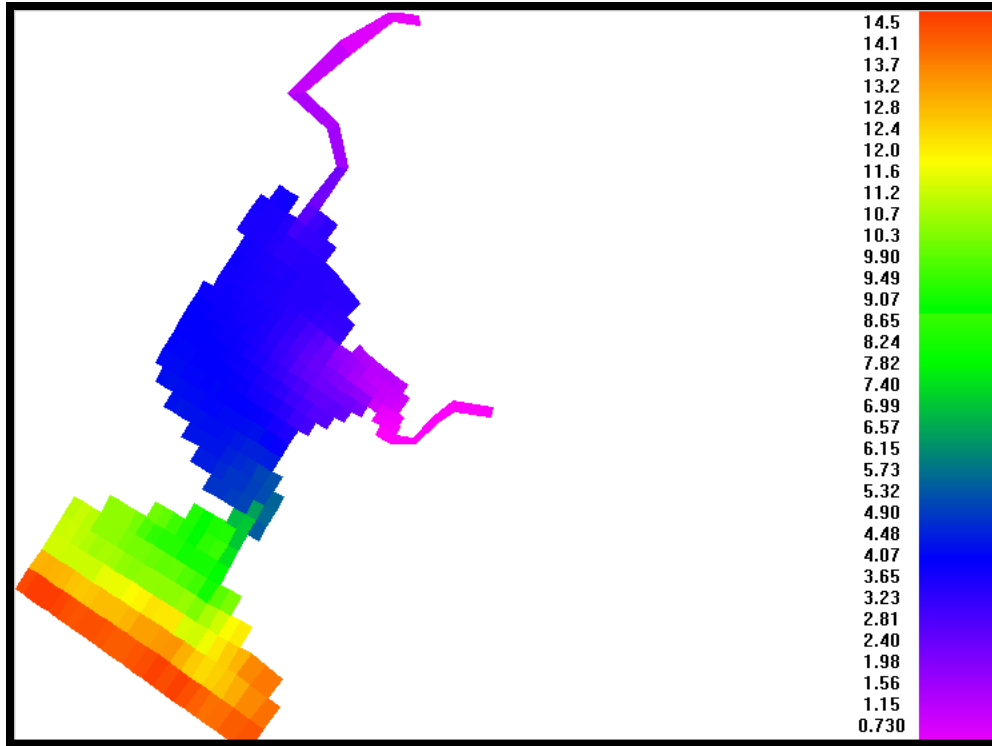

Figure C-6 50<sup>th</sup> percentile of bottom salinity (ppt)

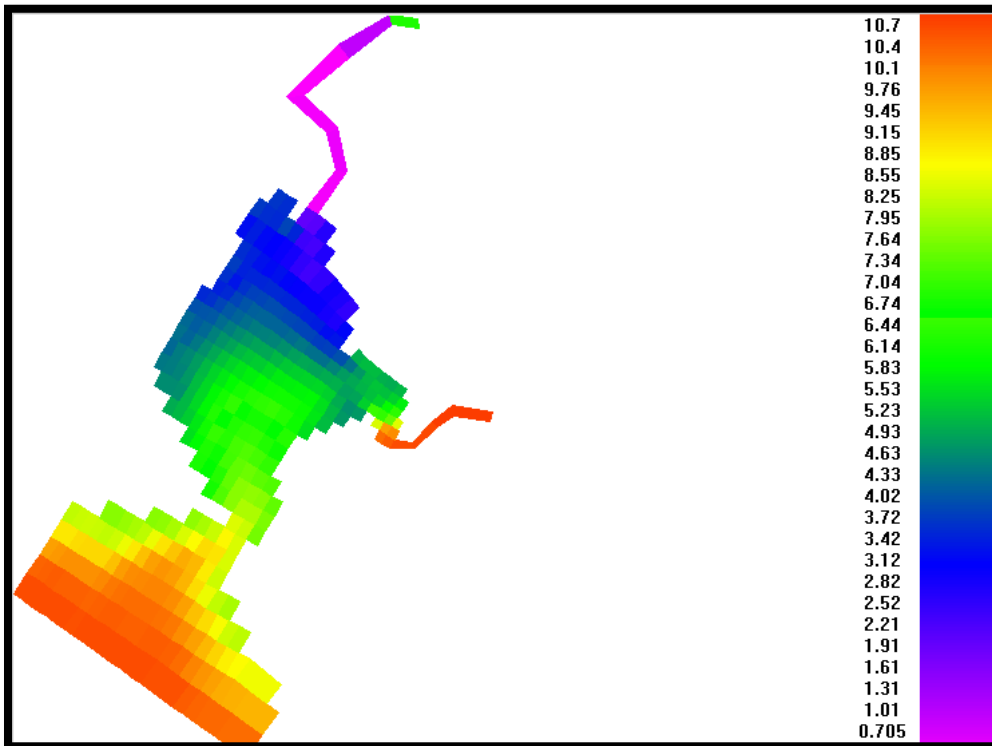

Figure C-7 50<sup>th</sup> percentile of bottom dissolved oxygen (mg/l)

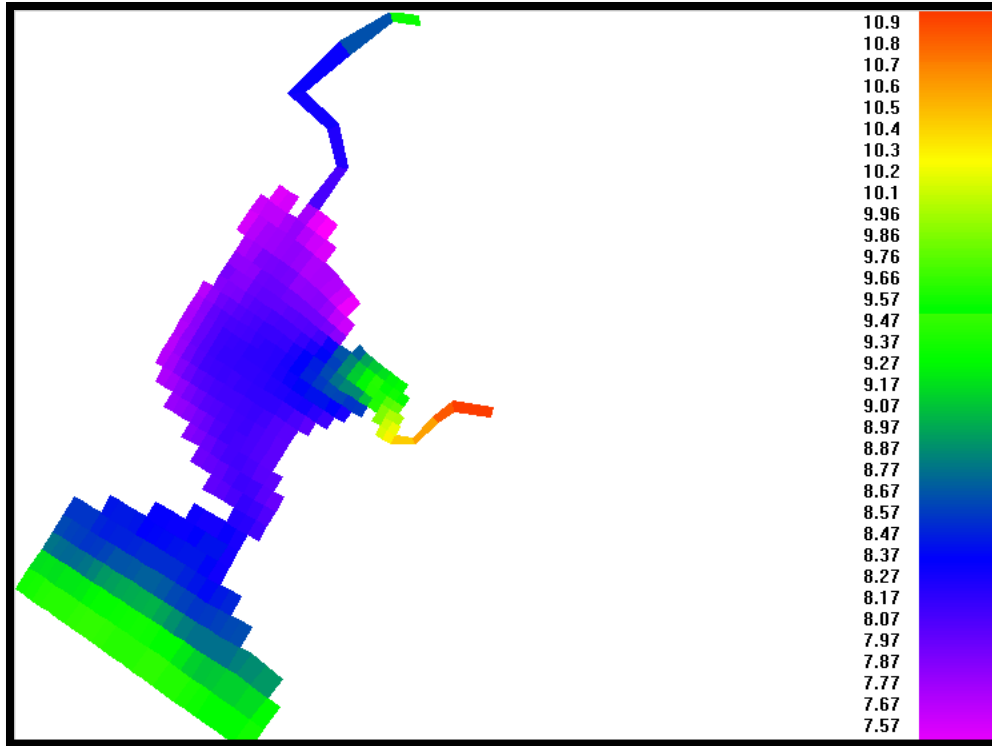

Figure C-8 50<sup>th</sup> percentile of surface dissolved oxygen (mg/l)

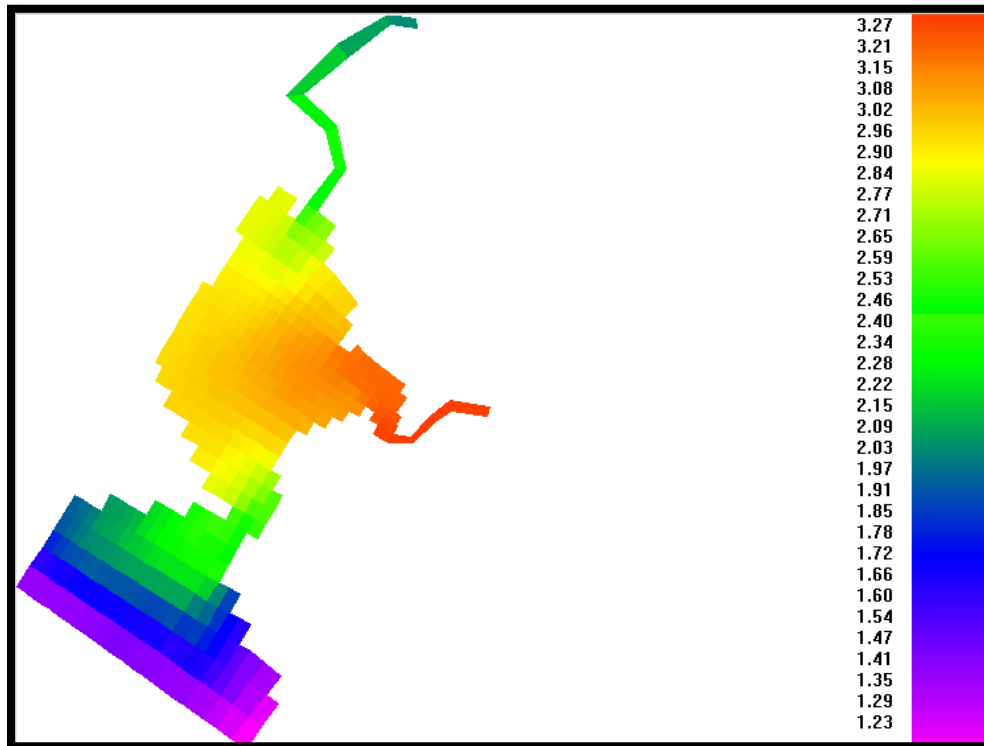

Figure C-9 50<sup>th</sup> percentile of light extinction coefficient (1/m)

